

DaVinci Advanced Panel Keycaps



DaVinci Advanced Panel Keycaps

Leading the Creative Video Revolution

Languages

To go directly to your preferred language, simply click on the hyperlinks listed in the contents below.

English	3
日本語	11
Français	20
Deutsch	29
Español	38
中文	47
한국어	56
Русский	65
Italiano	74
Português	83
Türkçe	92

Contents

DaVinci Advanced Panel Keycaps Upgrade	4
Removing the Keycaps from your Panel	5
Installing the New Keycaps on your Panel	6
Replacing the Soft Key and Soft Knob Caps	6
Keycap Module Layouts	8

DaVinci Advanced Panel Keycaps Upgrade

The DaVinci Advanced Panel Keycaps Upgrade updates your advanced panel so you can take full advantage of all the features in DaVinci Resolve 17.

The keycap upgrade kit provides three plastic shelves containing all the replacement keycaps you need for each module of your advanced panel. A keycap removal tool is also included to make removing the original keycaps quick and easy.

This guide shows you how to remove and replace the keycaps in your DaVinci Resolve Advanced Panel.

The advanced panel is divided into three modules.



1. T-bar panel 2. Trackball panel 3. Search Dial panel



The keycap upgrade kit is supplied in 3 shelves.

NOTE Before starting to remove the original keycaps, disconnect your advanced panel from the power supply. It's best to work in a well lit area and you may also want to get a container to store the original keycaps in.

Removing the Keycaps from your Panel

The keycaps in your panel are seated on a small plastic mount which the key is pressed into and held in place.

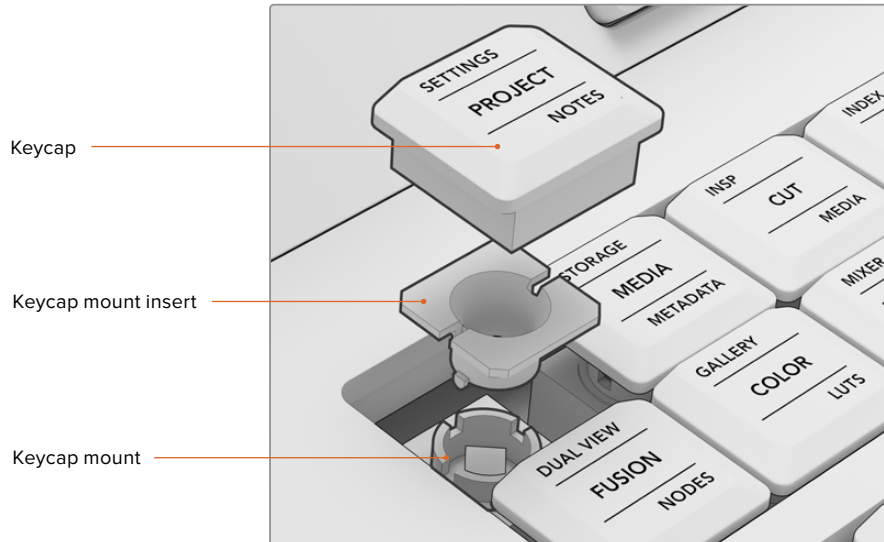

The construction of the keycap and the keycap mount

To remove a keycap

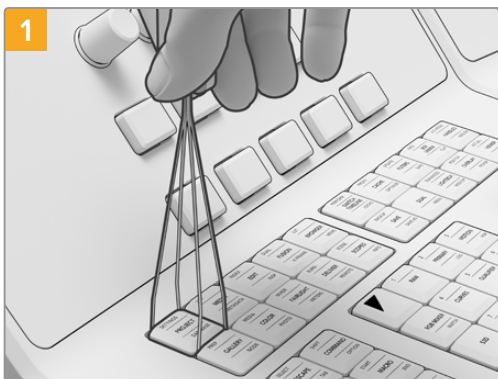

Place the ends of the keycap removal tool over each side of a keycap.

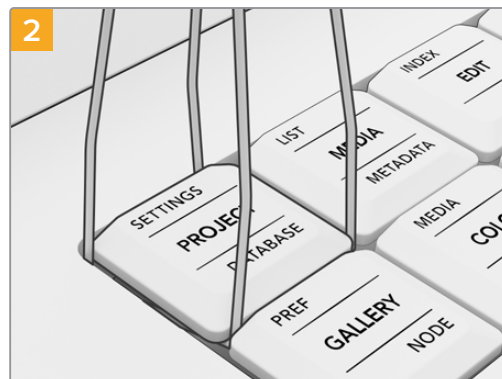

Turn the tool slightly to one side so the ends are underneath the corners of the keycap.

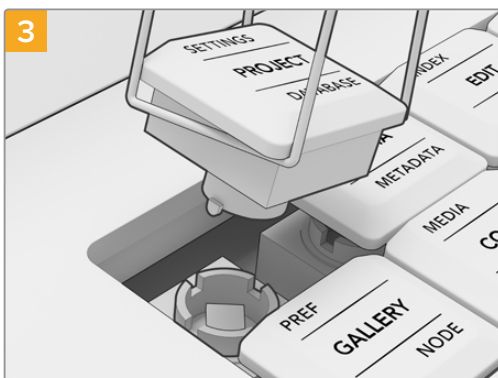

Keeping the removal tool at a right angle to the panel, gently lift up until the keycap is released from the mount.

NOTE Sometimes, when removing a keycap you might find that the cap's white mount insert separates from the cap and remains inside the panel. If this happens continue to remove the surrounding keycaps to make room, then use your fingers to remove the keycap mount insert from the panel.

When all the original keycaps have been removed from your advanced panel, you can now fit the keycap upgrade kit.

Installing the New Keycaps on your Panel

When installing the new keycaps, it's best to work with one panel module at a time with its matching replacement keycap shelf. As you install each keycap, refer to the 'keycap module layouts' section later in this manual to assign each keycap to its designated mount.

To install a keycap

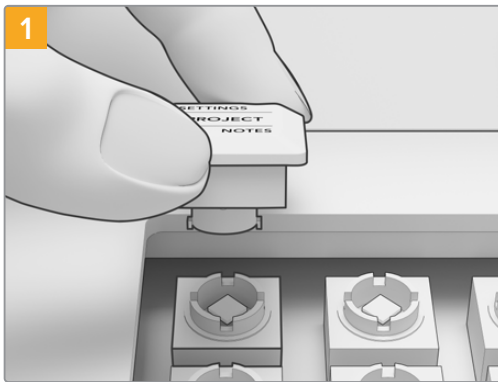

Align the mount insert of the keycap with the keycap mount inside the panel. The side tabs on the keycap insert will fit into the grooves on the keycap mount.

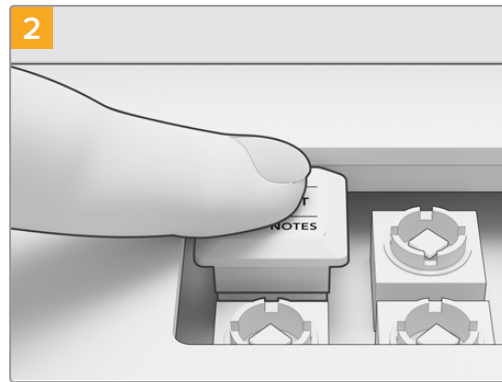

Gently push the keycap into the mount. The keycap should go into place easily and engage with a click.

When you have finished replacing the keycaps on all three sections of your advanced panel, reconnect the power and launch DaVinci Resolve 17. You can then configure DaVinci Resolve for the updated panel.

To configure the panel:

- 1 Go to preferences > control panel
- 2 From the 'Color Grading Panel' menu, choose 'DaVinci Resolve Advanced Panel 2'
- 3 Click 'save'

Replacing the Soft Key and Soft Knob Caps

The DaVinci Advanced Panel Keycaps Upgrade also comes with replacement soft key and soft knob caps. These are direct replacements for the original caps so fitting them is optional. They're useful if your original soft caps are getting worn.

Replacing the Soft Keycaps

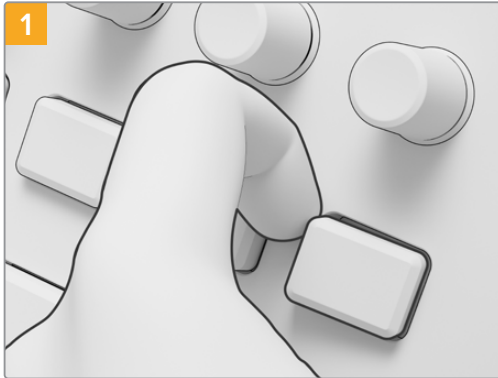

To remove a soft key, gently pull one corner until the cap is released from its mount.

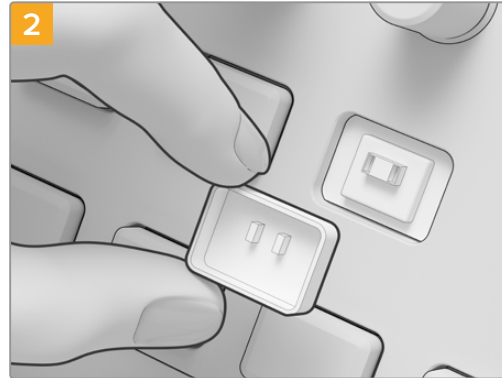

To fit a replacement soft keycap, make sure that the two small plastic tabs at the back of the cap are aligned with the slots on the mount. The tabs are positioned slightly above center. Push the cap into place until you feel it click.

Replacing the Soft knob caps

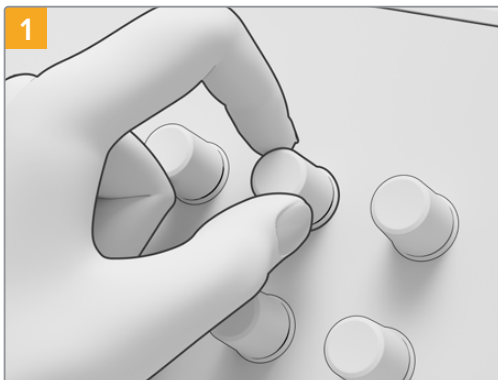

To remove the soft knob caps, firmly grip the cap between your forefinger and thumb and pull the cap away from its spindle mount.

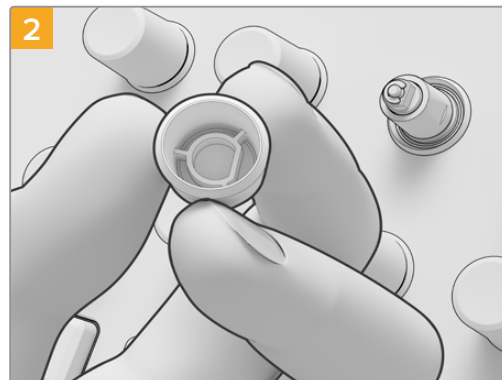

To fit a new soft knob cap, align the D shaped insert in the cap with the top of the spindle.

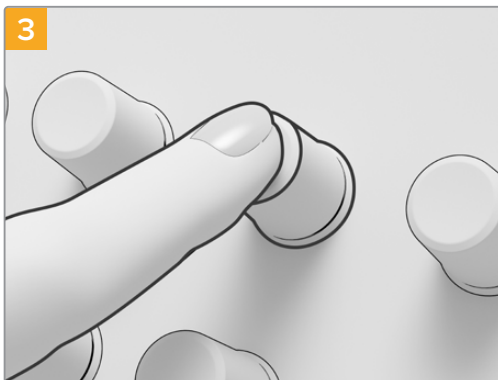

Push the cap onto the spindle until the cap is flush with the base of the spindle.

Keycap Module Layouts

The module layouts in this section show the position for each button on the three panel modules. Refer to this section as you install each keycap on your advanced panel.

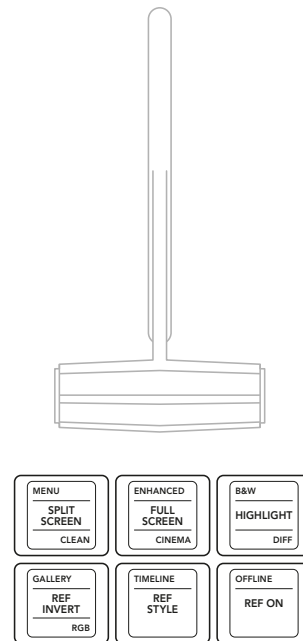
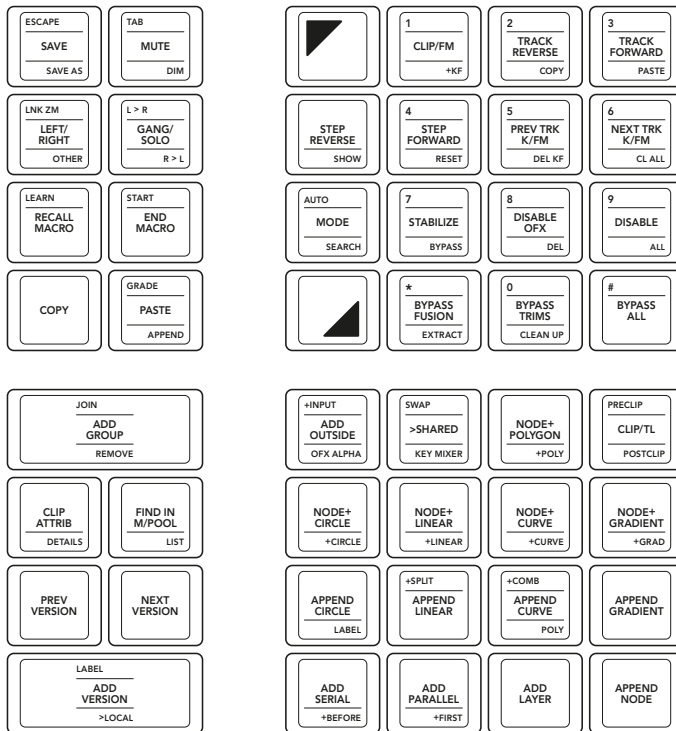
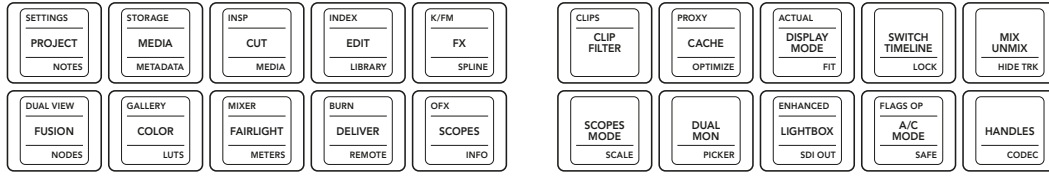

T-Bar Panel

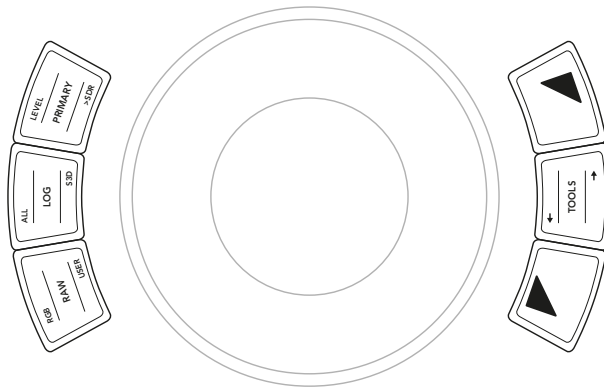
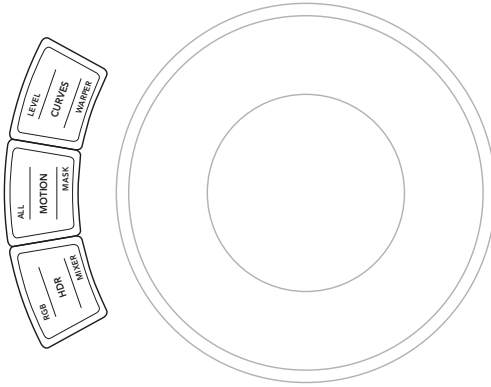
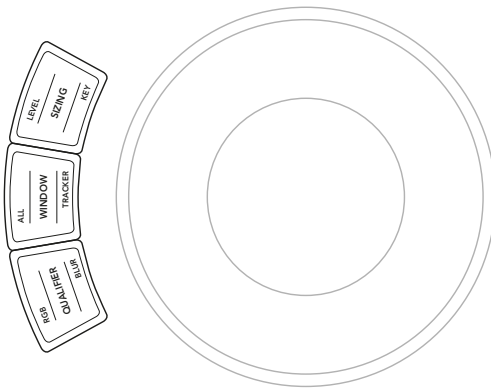
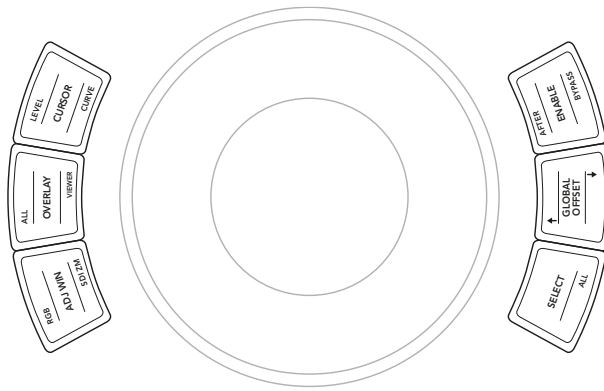

Trackball Panel

ALL RESET NODE GRADES	Q A I	R B J	S C K	T D L	CRNT
INFO DISPLAY GRAPH MEMS	U E M	V F N	W G O	X H P	+POWER +PAGE LABEL
INSERT APPLY GRADE LABEL	APPEND GRADE DEL	-2 PREV PAGE MATCH FM	-1 NEXT PAGE	NONE USE SRC TC START FM	GROUP RIPPLE SEL APPEND
MISSING GRAB STILL MIDDLE					P/PONG LOOP PLAYHEAD

FLAG PREV STILL	FLAG NEXT STILL	CUE FIRST FRAME	CUE LAST FRAME		
FIRST STILL PREV NODE	LAST NEXT NODE	MARKER PREV FRAME	MARKER NEXT FRAME	START PREV CLIP	END NEXT CLIP
	SLOW 	REVIEW 	SLOW 		

SCENE UNDO NEXT CLIP	SPLIT REDO JOIN	IN CLEAR I	DUR OUT CLEAR O
SHOW FLAG CLIP	SHOW MARKER NODE	1/2 P/LITE 1/4	FLAG DELETE MARKER
ORIG MEM	PVW MEM	SCROLL	SAME SELECT NODE LAST ADJ
+R NUM LK	+G /	+B *	+MASTER BACK SPACE
-R 7 CHR LT	-G 8 CHR DK	-B 9 LT DARK	-MASTER /
+C 4 MAGENTA	+M 5 BLUE	+Y 6 CYAN	:
-C 1 GREEN	-M 2 YELLOW	-Y 3 RED	CLOSE CLEAR
+	0	-	ENTER
RIPPLE VALUE APPEND	LOCK KEYFRAME MODE AUTO	EXPAND LIFT KF DEL KF	
PREV KF ATTRIB	ZOOM ADD KEYFRAME +STATIC	NEXT KF	

SearchDial Panel

2021年3月
インストールガイド

Blackmagicdesign

DaVinci Advanced Panelキーキャップ



DaVinci Advanced Panelキーキャップ
Leading the Creative Video Revolution

日本語

目次

DaVinci Advanced Panelキーキャップのアップグレード	13
パネルからキーキャップを外す	14
新しいキーキャップをパネルに取り付ける	15
ソフトキーキャップとソフトノブキャップを交換する	15
キーキャップモジュールのレイアウト	17

DaVinci Advanced Panel キーキャップのアップグレード

「DaVinci Advanced Panelキーキャップのアップグレード」は、Advanced PanelをアップグレードしてDaVinci Resolve 17のすべての機能を最大限に活用する方法を説明します。

キーキャップのアップグレードキットには3つのプラスチック製シェルフが含まれており、Advanced Panelの各モジュールに必要な交換用キーキャップがすべて入っています。また、オリジナルキーキャップをすばやく簡単に取り外すためのキーキャップ除去ツールも同梱されています。

このガイドでは、DaVinci Advanced Panelのキーキャップを取り外して交換する方法を説明します。

DaVinci Advanced Panelは3つのモジュールに分かれています。



1. Tバーパネル 2.トラックボールパネル 3.サーチダイヤルパネル



キーキャップのアップグレードキットは3つのシェルフです。

メモ オリジナルキーキャップを取り外す前に、DaVinci Advanced Panelの電源を抜いてください。明るい環境で作業することをお勧めします。オリジナルキーキャップは容器などに保管してください。

パネルからキーキャップを外す

パネルのキーキャップは小さなプラスチックマウントに固定されており、ここにキーが押し込まれる仕組みになっています。

キーキャップ
キーキャップマウントインサート
キーキャップマウント

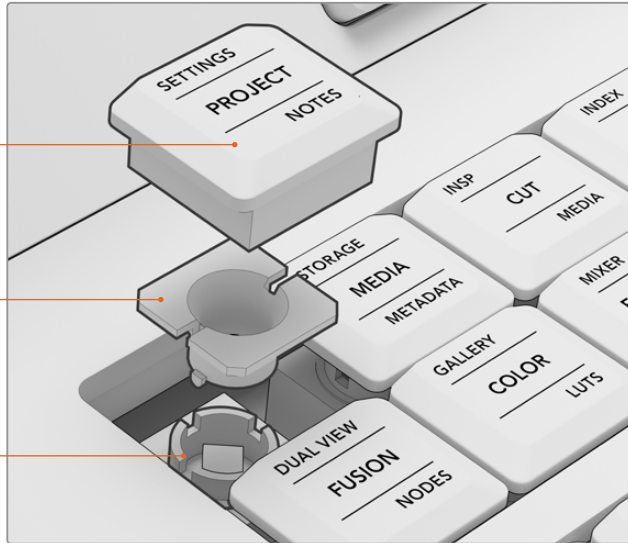

キーキャップおよびキーキャップマウントの構造

キーキャップを取り外す

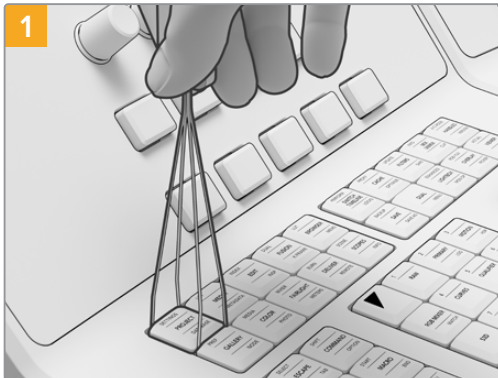

キーキャップ除去ツールの両方の底部をキーキャップの両側に合わせます。

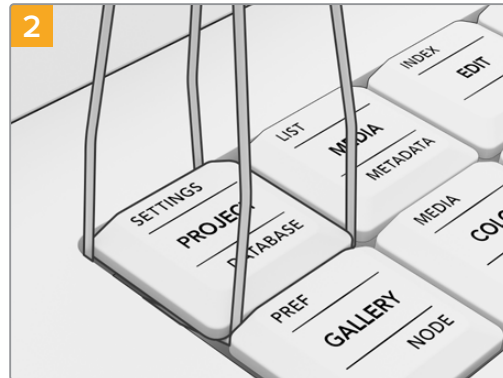

除去ツールを一方に回すように少し動かして、両側をキーキャップの角の下に差し込みます。

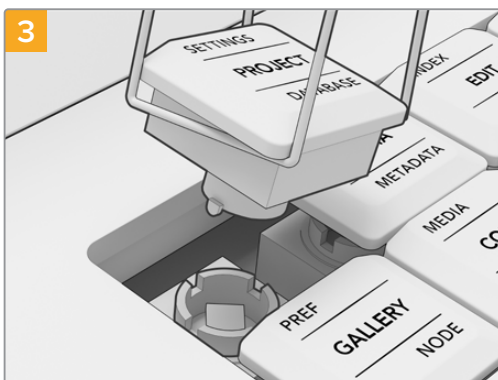

除去ツールをパネルに対して適切な角度に維持したまま、キーキャップがマウントから外れるまでゆっくりと持ち上げます。

メモ キーキャップを取り外す際は、白いマウントインサートがキャップから外れ、パネル内に残ることがあります。その場合は、周囲のキーキャップを取り外してスペースを作り、指でキーキャップマウントインサートをパネルから取り外してください。

オリジナルキーキャップをAdvanced Panelから外したら、Keycap Upgradeキットを取り付けられます。

新しいキーキャップをパネルに取り付ける

新しいキーキャップを取り付ける際は、1つのパネルずつ作業を行い、正しい交換用キーキャップシェルフを使用することが大切です。各キーキャップを取り付ける際は、このマニュアルの「キーキャップモジュールのレイアウト」セクションを参照して、各キーキャップを指定されたマウントに取り付けてください。

キーキャップを取り付ける

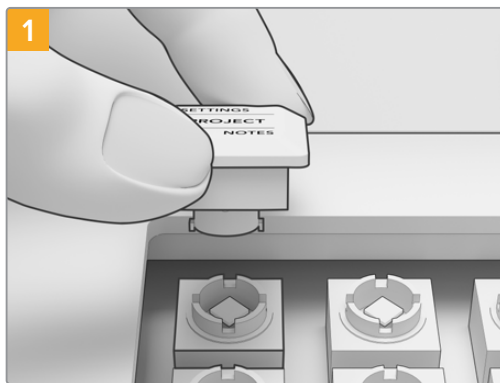

キーキャップのマウントインサートをパネル内のキーキャップマウントに合わせます。キーキャップインサートの両側のタブをキーキャップマウントの溝にはめます。

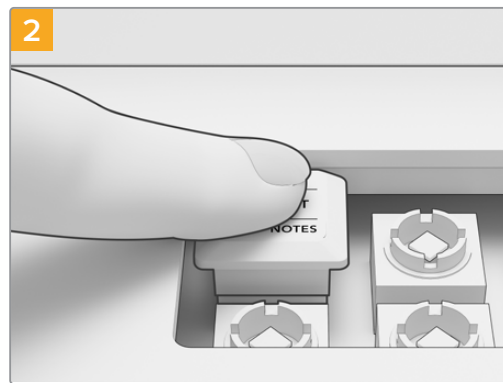

キーキャップをマウントにゆっくと押し込むと、カチッという音がして所定の位置に固定されます。

Advance Panelの3つのパネルすべてのキーキャップを交換したら、電源をつないでDaVinci Resolve 17を起動します。次に、更新したパネルのコンフィギュレーションをDaVinci Resolveで行います。

パネルのコンフィギュレーションを実行する：

- 1 「環境設定」>「コントロールパネル」を開きます。
- 2 「カラーグレーディングパネル」メニューで「DaVinci Resolve Advanced Panel 2」を選択します。
- 3 「Save」をクリックします。

ソフトキーキャップとソフトノブキャップを交換する

DaVinci Advanced Panelキーキャップアップグレードには、交換用のソフトキーキャップおよびソフトノブキャップも同梱されています。これらはオリジナルキャップの交換用であり、使用するかどうかは任意です。オリジナルキャップが磨耗した際などの交換に使用できます。

ソフトキーキャップを交換する

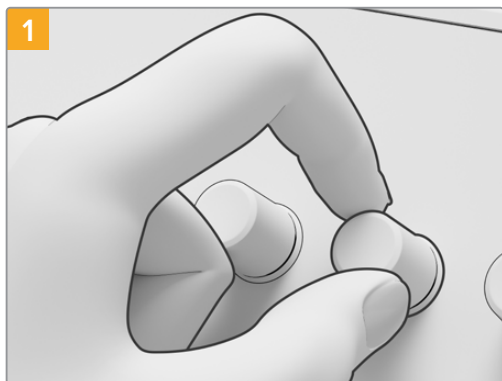

ソフトキーを取り外すには、ひとつの角から引き出すようにしてマウントから外します

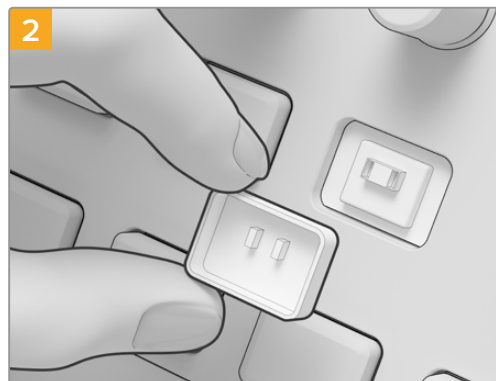

交換用ソフトキーキャップを取り付けるには、キャップの裏側にある2つの小さなプラスチックタブをマウントのスロットに合わせます。これらのタブは中心よりやや上に配置されています。キャップをカチッという感触があるまで押し込んで固定します。

ソフトノブキャップを交換する

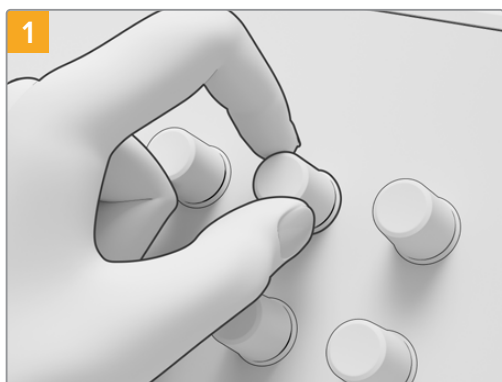

ソフトノブキャップを取り外すには、親指と人差し指でキャップをしっかりとつまみ、引っぱってスピンドルマウントから外します。

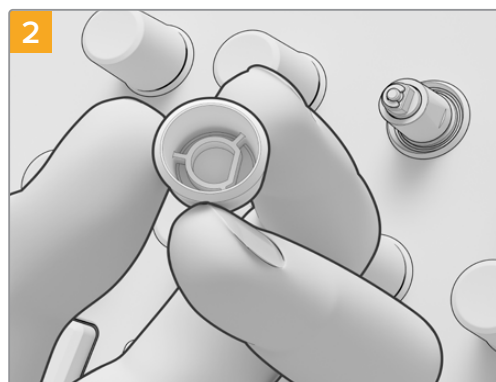

新しいソフトノブキャップを取り付けるには、キャップ内のD字型のインサートをスピンドルの上部に合わせます。

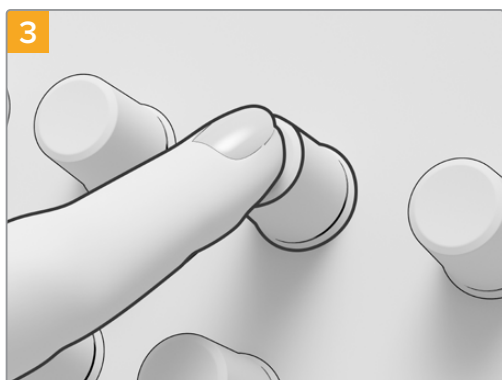

キャップをスピンドルの根元まで押し込みます。

キーキャップモジュールのレイアウト

このセクションのモジュールレイアウトは、3つのパネルモジュールの各ボタンの位置を示しています。Advanced Panelに各キーキャップを取り付ける際は、このセクションを参照してください。

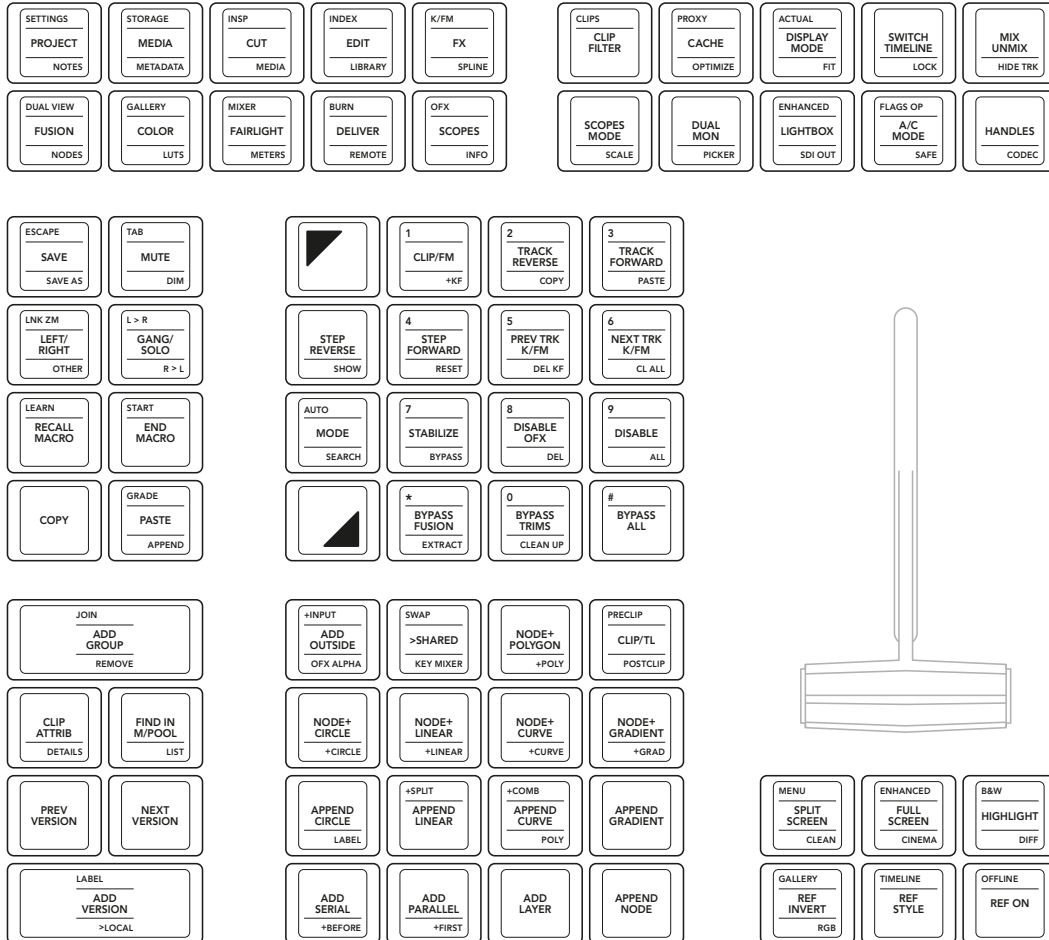

トパーパネル

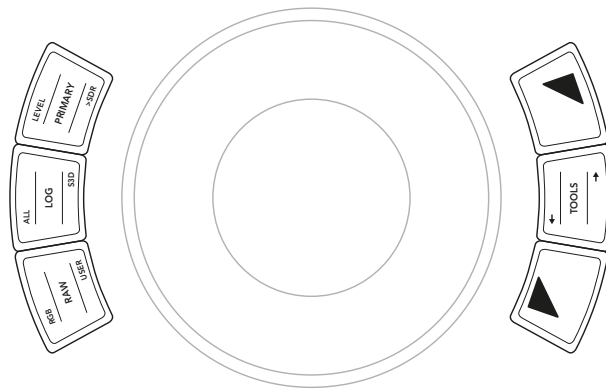
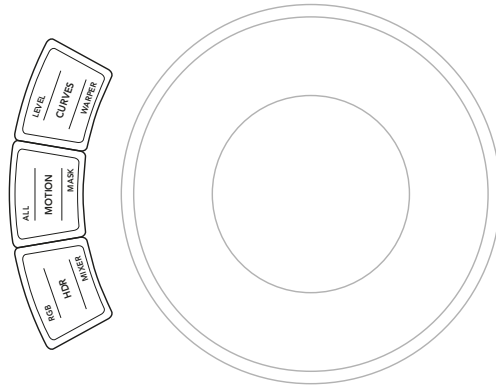
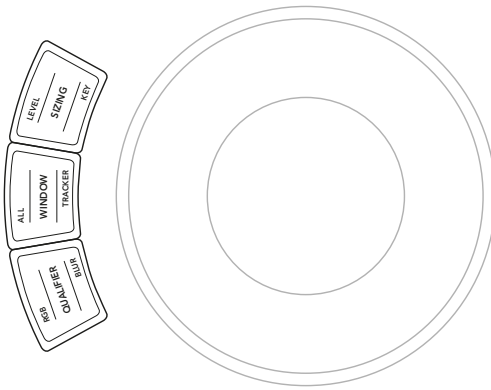
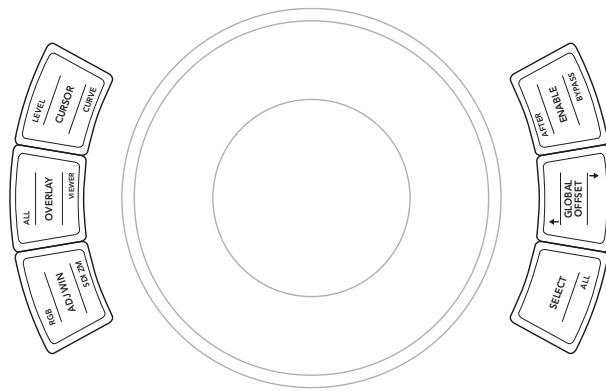

トラックボールパネル

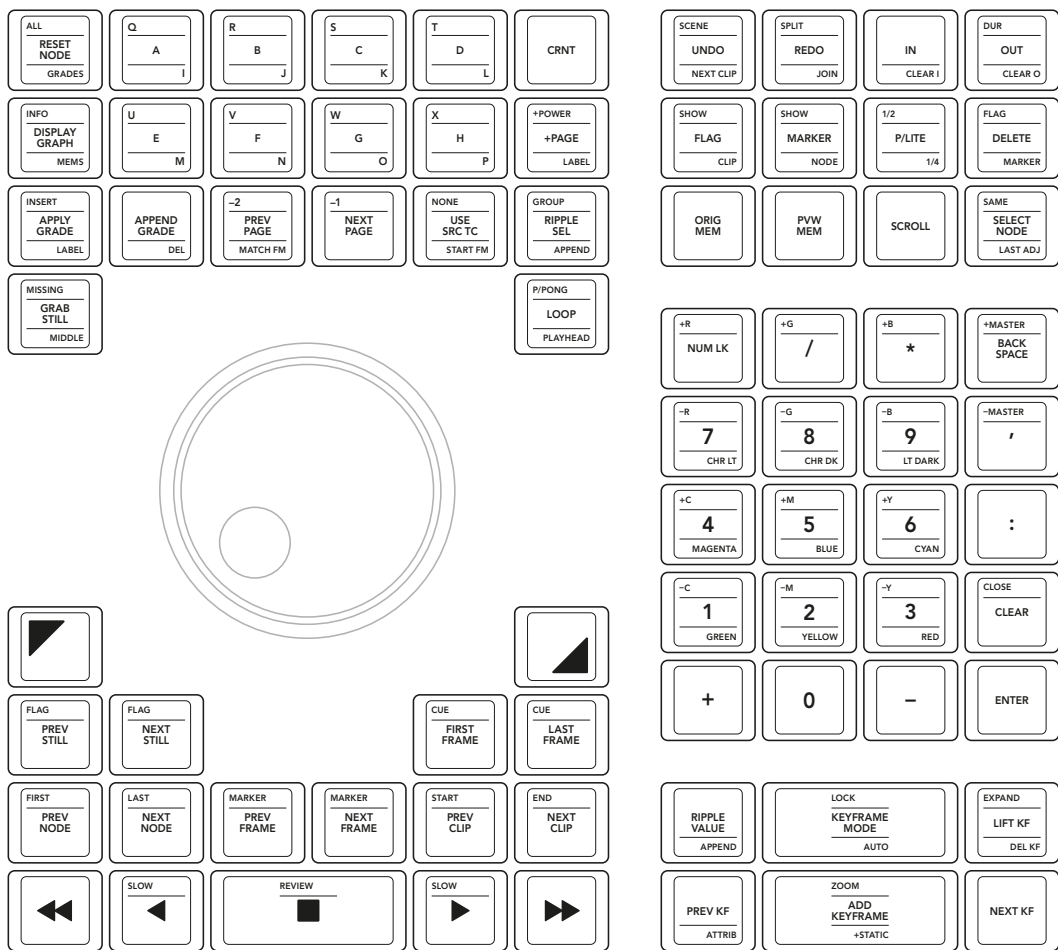

サーチダイヤルパネル

Capuchons de touche pour le DaVinci Advanced Panel



Capuchons de touche pour
le DaVinci Advanced Panel

À la pointe de la révolution vidéo

Français

Sommaire

Mise à jour des capuchons de touche pour le DaVinci Advanced Panel	22
Retirer les capuchons du panneau	23
Installer les nouveaux capuchons sur votre panneau	24
Remplacer les capuchons des touches et des molettes multifonction	24
Disposition des capuchons selon le module	26

Mise à jour des capuchons de touche pour le DaVinci Advanced Panel

La mise à jour des capuchons de touche du DaVinci Resolve Advanced Panel vous permet de mettre à jour votre Advanced Panel afin de profiter pleinement de toutes les fonctionnalités de DaVinci Resolve 17.

Le kit de mise à jour des capuchons de touche comprend trois pochettes en plastique qui contiennent tous les capuchons de touche dont vous avez besoin pour chaque module de l'Advanced Panel. Un extracteur de capuchon de touche est également fourni pour vous permettre de retirer facilement les capuchons originaux.

Ce guide décrit comment retirer et remplacer les capuchons de touche du DaVinci Resolve Advanced Panel.

L'Advanced Panel est divisé en trois modules.



1. Panneau du levier de transition 2. Panneau des boules de commande 3. Panneau de la molette



Le kit de mise à jour des capuchons de touche comprend 3 pochettes.

REMARQUE Avant de commencer à retirer les capuchons originaux, débranchez l'alimentation de votre Advanced Panel. Nous vous recommandons de travailler dans un endroit bien éclairé et d'utiliser un récipient pour ranger les capuchons originaux.

Retirer les capuchons du panneau

Les capuchons de touche de votre panneau sont maintenus en place grâce à un petit support en plastique dans lequel ils sont insérés.

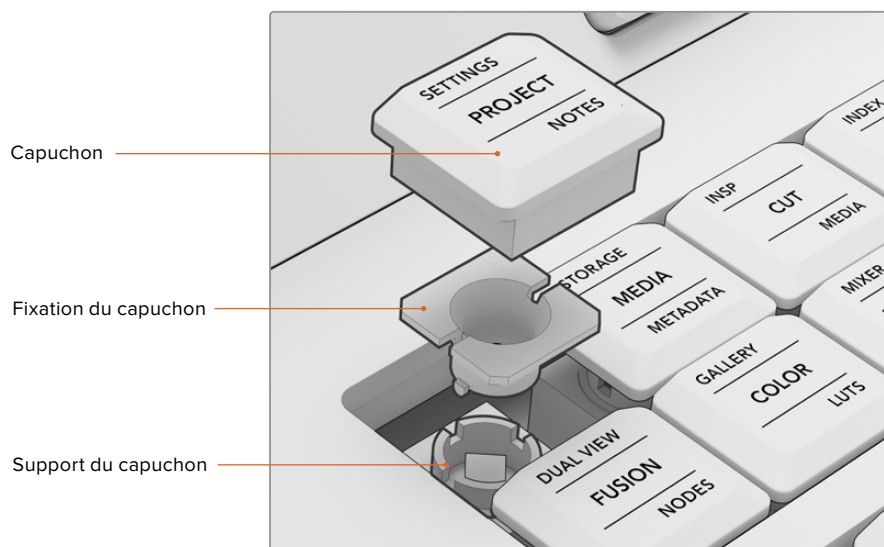

Agencement du capuchon de touche et de son support

Pour retirer un capuchon de touche :

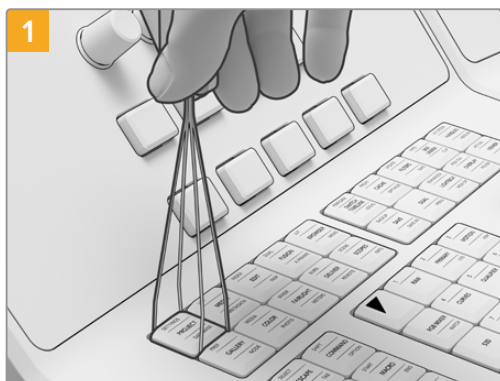

Placez les extrémités de l'extracteur de capuchon de touche de part et d'autre du capuchon.

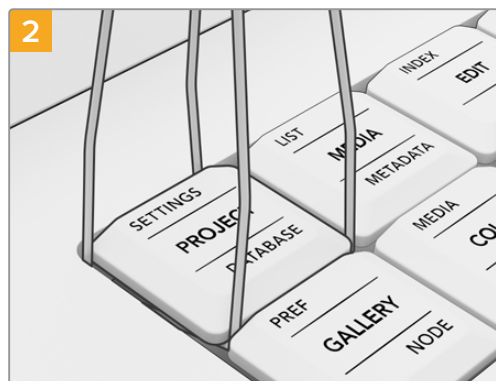

Faites légèrement pivoter l'extracteur afin de placer les extrémités sous les coins du capuchon.

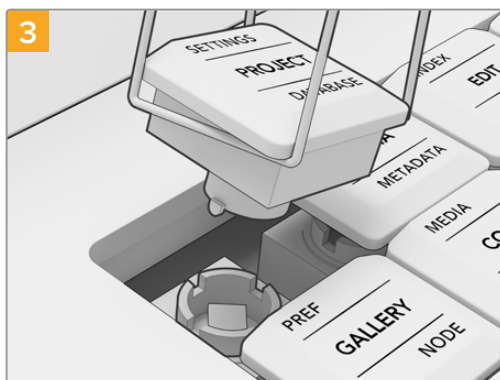

Tout en gardant un angle droit entre l'extracteur et le panneau, soulevez délicatement le capuchon jusqu'à ce qu'il se détache du support.

REMARQUE Parfois, lorsque vous retirez un capuchon, il se peut que la fixation se sépare du capuchon et reste sur le panneau. Le cas échéant, continuez à retirer les capuchons adjacents pour faire de la place, puis utilisez vos doigts pour retirer la fixation du panneau.

Lorsque tous les capuchons originaux ont été retirés de votre Advanced Panel, vous pouvez installer le kit de mise à jour.

Installer les nouveaux capuchons sur votre panneau

Lorsque vous installez les nouveaux capuchons, il est recommandé de travailler sur un module à la fois, avec la pochette de nouveaux capuchons correspondante. Au fur et à mesure que vous installez les capuchons, référez-vous à la section « Disposition des capuchons selon le module » de ce guide afin d'attribuer chaque capuchon à son support dédié.

Pour installer un capuchon

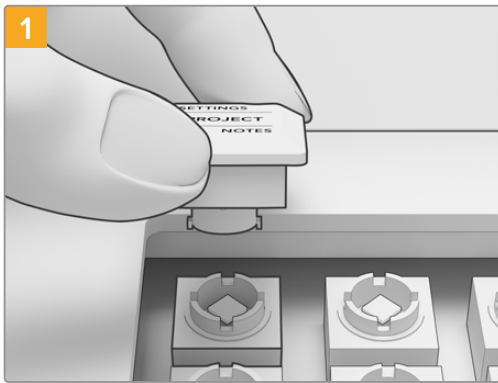

Alignez la fixation du capuchon avec le support pour capuchon du panneau. Les attaches latérales de la fixation s'insèrent parfaitement dans les entailles du support pour capuchon.

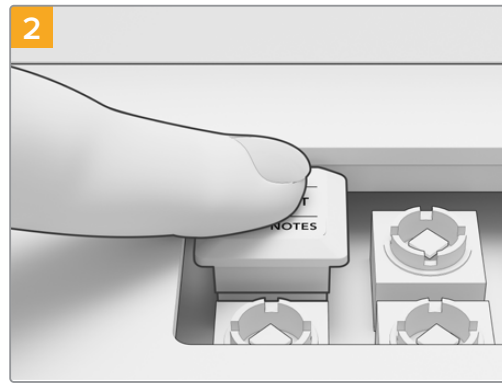

Poussez délicatement le capuchon sur le support. Vous devriez entendre un clic lorsque le capuchon se met en place.

Lorsque vous avez terminé de remplacer tous les capuchons des trois modules de votre Advanced Panel, rebranchez l'alimentation et ouvrez DaVinci Resolve 17. Vous pourrez ensuite configurer DaVinci Resolve pour le panneau mis à jour.

Pour configurer le panneau :

- 1 Allez dans **Préférences > Control panel**.
- 2 Dans le menu **Color Grading Panel**, choisissez **DaVinci Resolve Advanced Panel 2**.
- 3 Cliquez sur **Save**.

Remplacer les capuchons des touches et des molettes multifonction

La mise à jour des capuchons de touche du DaVinci Resolve Advanced Panel comprend également des capuchons pour les touches et les molettes multifonction. Ce sont des remplacements identiques aux capuchons d'origine. Leur installation est donc optionnelle. Ils sont utiles lorsque les capuchons originaux deviennent usés.

Remplacer les capuchons des touches multifonction

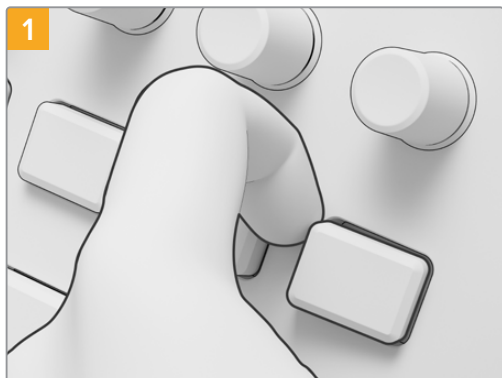

1 Pour retirer une touche multifonction, tirez délicatement un coin du capuchon jusqu'à ce qu'il se libère de son support.

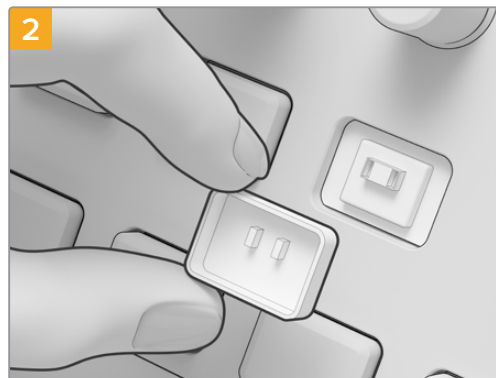

2 Pour installer le nouveau capuchon, veillez à ce que les deux petites attaches en plastique situées à l'arrière du capuchon soient alignées avec les entailles du support. Les attaches sont positionnées un peu plus haut que le centre du capuchon. Poussez le capuchon jusqu'à ce que vous entendiez un clic.

Remplacer les capuchons des molettes multifonction

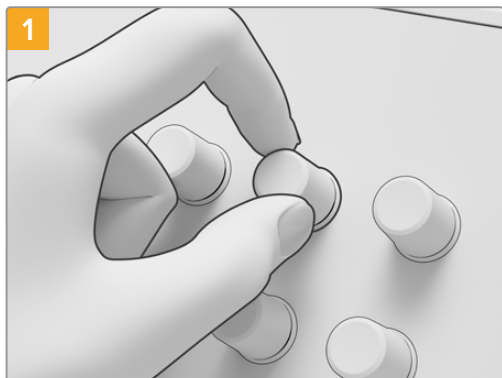

1 Pour retirer le capuchon d'une molette multifonction, tenez le capuchon fermement entre votre pouce et votre index et tirez le capuchon hors de son support.

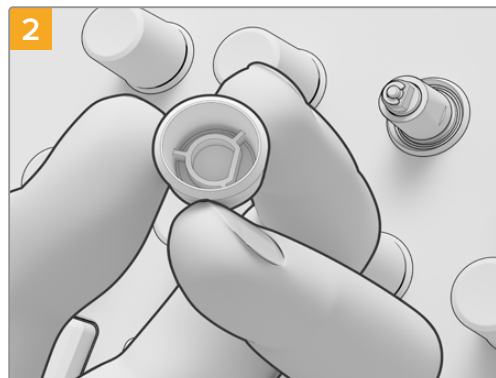

2 Pour installer un nouveau capuchon, alignez la forme en D située dans le capuchon avec le haut du support.

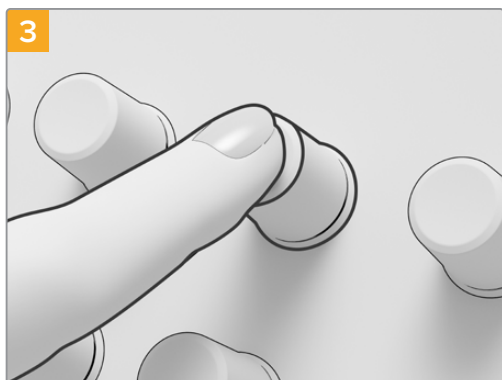

3 Poussez le capuchon sur le support jusqu'à ce qu'il s'aligne avec sa base.

Disposition des capuchons selon le module

Les schémas de cette section montrent l'emplacement de chaque bouton sur les trois modules du panneau. Référez-vous à cette section lorsque vous installez les capuchons de votre Advanced Panel.

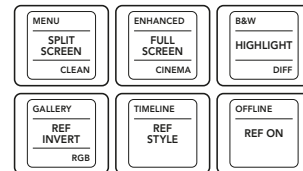
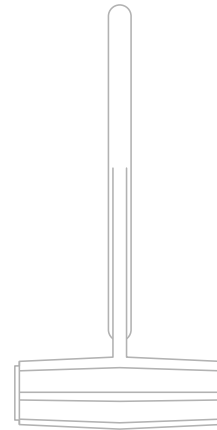
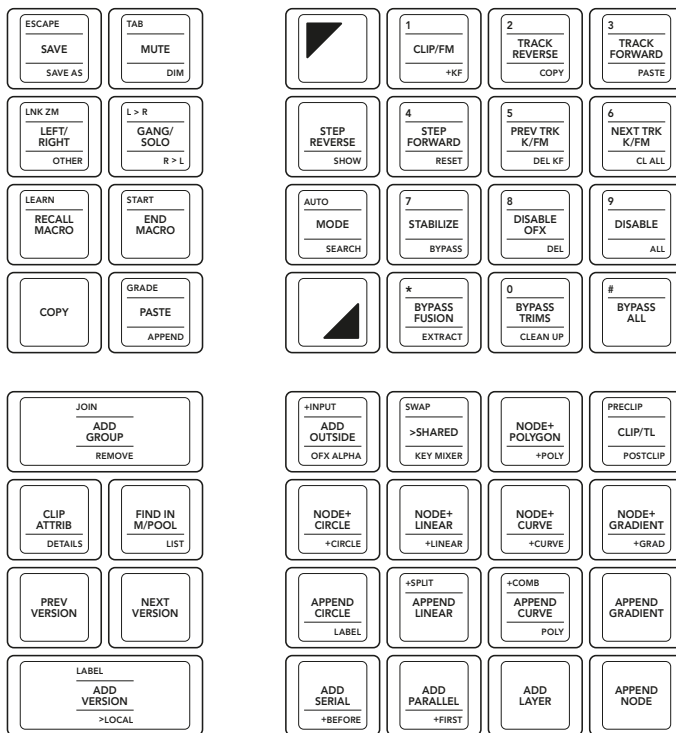
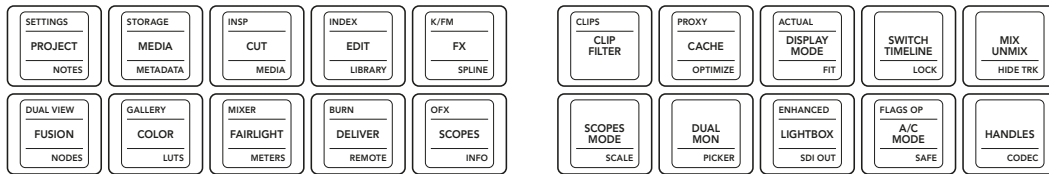

Panneau du levier de transition

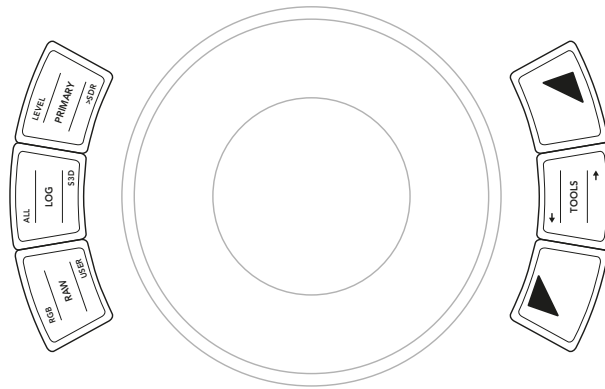
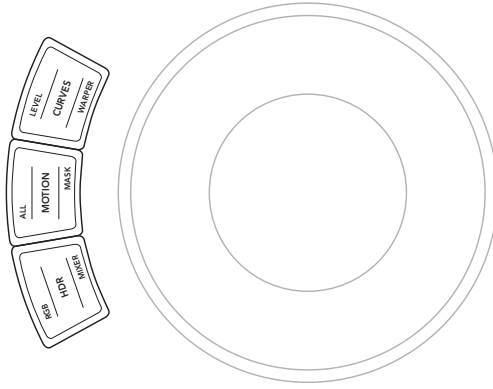
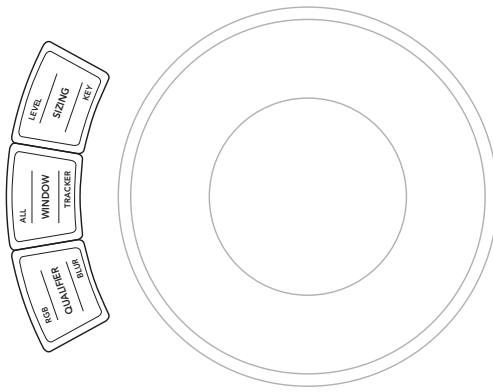
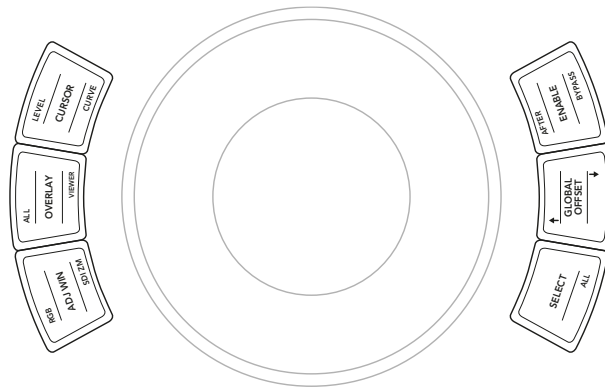

Panneau des boules de commande

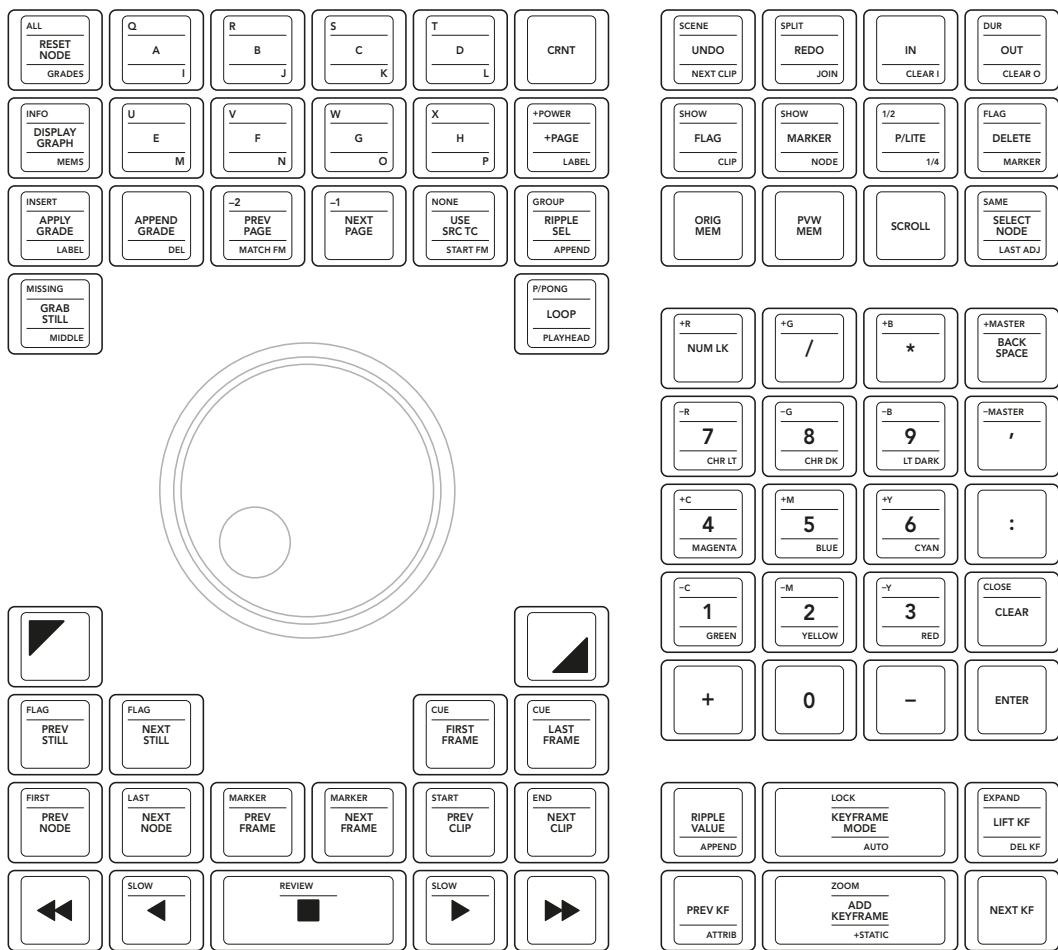

Panneau de la molette

DaVinci Advanced Panel Keycaps



Inhaltsverzeichnis

DaVinci Advanced Panel Keycaps Upgrade	31
Entfernen der Tastenkappen von Ihrem Panel	32
Anbringen neuer Tastenkappen an Ihrem Panel	33
Ersetzen der Kappen von Multifunktionstasten und -reglern	33
Anordnung der Tastenkappen nach Modulen	35

DaVinci Advanced Panel Keycaps Upgrade

Das DaVinci Advanced Panel Keycaps Upgrade aktualisiert Ihr Advanced Panel, damit Sie alle Funktionen in DaVinci Resolve 17 voll ausnutzen können.

Auf drei Kunststoff-Trays verpackt, stellt Ihnen das Keycap Upgrade Kit Ersatz für die Tastenkappen aller Module Ihres Advanced Panels bereit. Das Kit enthält auch ein Abziehwerkzeug, mit dem sich die originalen Tastenkappen schnell und bequem entfernen lassen.

Diese Anleitung erklärt, wie Sie die Tastenkappen auf Ihrem DaVinci Advanced Panel abziehen und ersetzen.

Das Advanced Panel besteht aus drei separaten Modulen.



1. T-bar Panel 2. Trackball Panel 3. Search Dial Panel

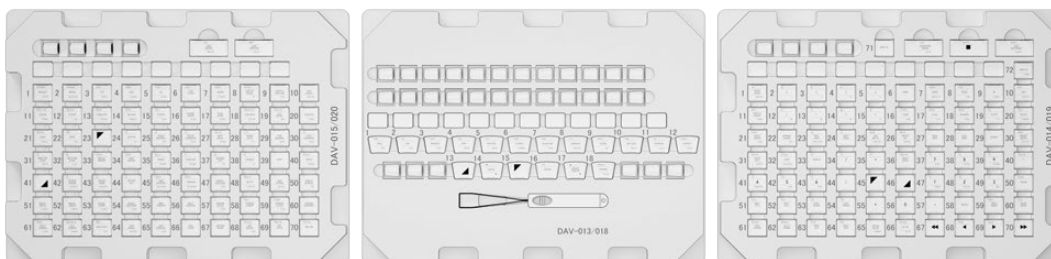

Das Keycap Upgrade Kit ist auf 3 Kunststoff-Trays verpackt

HINWEIS Trennen Sie die Stromzufuhr zu Ihrem Advanced Panel, bevor Sie mit dem Entfernen der originalen Tastenkappen beginnen. Es ist ratsam, bei guter Beleuchtung zu arbeiten und einen Behälter zum Aufbewahren der originalen Tastenkappen zur Hand zu haben.

Entfernen der Tastenkappen von Ihrem Panel

Die Tastenkappen Ihres Pults sitzen auf kleinen Kunststoffhalterungen, auf denen sie durch Drücken einrasten.

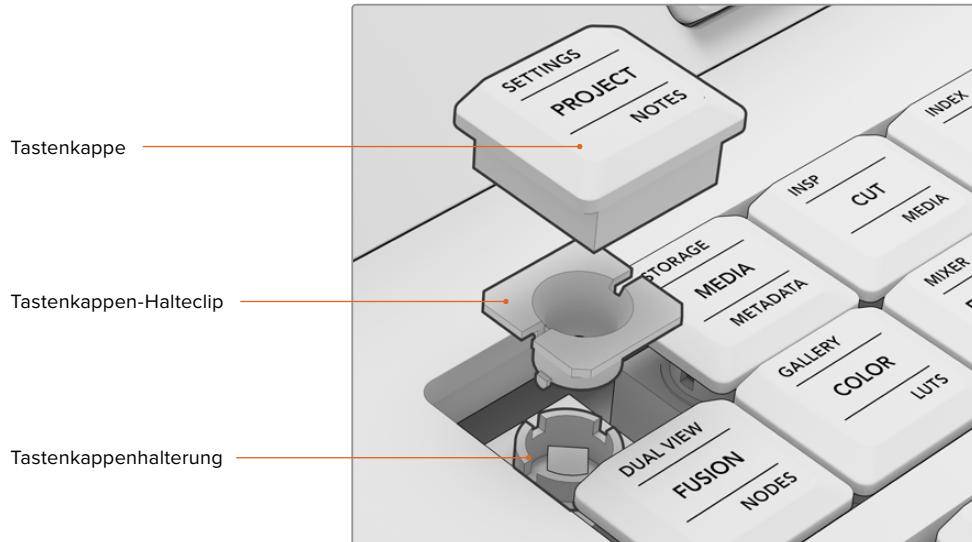

Aufbau einer Tastenkappe und der Tastenkappenhalterung

Entfernen von Tastenkappen

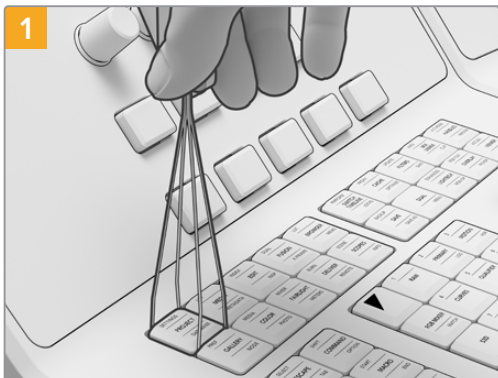

1 Setzen Sie die Bügel des Abziehwerkzeugs längsseits auf eine Tastenkappe.

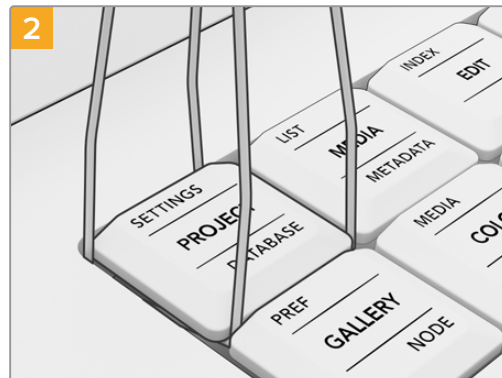

2 Drehen Sie das Werkzeug ein wenig, bis seine Bügel unter den Ecken der Tastenkappe einhaken.

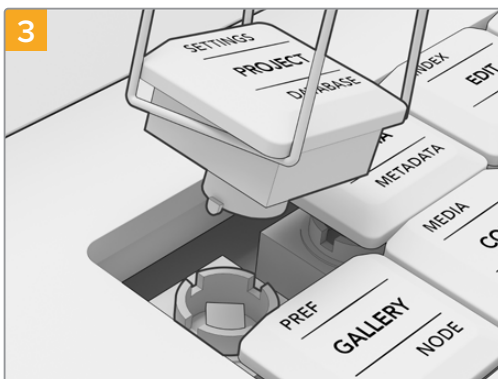

3 Ziehen Sie das Werkzeug behutsam senkrecht hoch, bis sich die Tastenkappe von ihrer Halterung gelöst hat.

HINWEIS Es kann beim Entfernen einer Tastenkappe passieren, dass sich dabei der weiße Halteclip von der Kappe löst und im Pult stecken bleibt. Entfernen Sie in diesem Fall auch die umliegenden Tastenkappen. Das schafft Platz, um den Halteclip mit den Fingern aus dem Pult zu nehmen.

Nachdem Sie alle originalen Tastenkappen von Ihrem Advanced Panel entfernt haben, können Sie die Tastenkappen aus dem Keycap Upgrade Kit anbringen.

Anbringen neuer Tastenkappen an Ihrem Panel

Beim Anbringen neuer Tastenkappen ist es ratsam, sich jeweils ein Panelmodul mit dem dazugehörigen Ersatztastenkappen-Tray vorzunehmen. Orientieren Sie sich beim Anbringen der einzelnen Tastenkappen am Abschnitt „Anordnung der Tastenkappen nach Modulen“

Anbringen von Tastenkappen

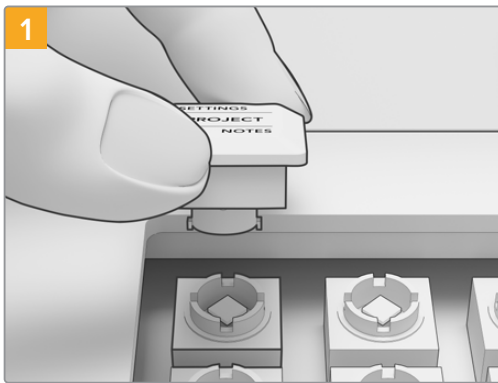

Richten Sie den Halteclip für eine Tastenkappe auf die Tastenkappenhalterung im Pult aus. Die seitlichen Zapfen am Halteclip passen in die Aussparungen an der Tastenkappenhalterung.

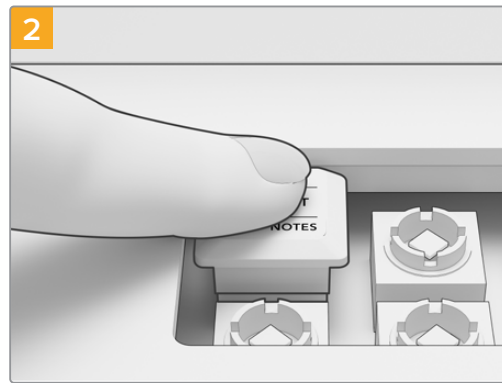

Drücken Sie die Tastenkappe vorsichtig in die Halterung. Die Tastenkappe sollte widerstandslos mit einem Klickgeräusch einrasten.

Wenn Sie die Tastenkappen auf allen drei Modulen Ihres Advanced Panels angebracht haben, schließen Sie das Pult wieder an das Stromnetz an und starten Sie DaVinci Resolve 17. Nun können Sie DaVinci Resolve für das aktualisierte Pult konfigurieren.

Konfigurieren des Pults:

- 1 Gehen Sie zu „Preferences“ > „Control Panel“ („Einstellungen“ > „Steuerpult“).
- 2 Wählen Sie im Menü „Color Grading Panel“ die Option „DaVinci Resolve Advanced Panel 2“.
- 3 Klicken Sie zum Speichern auf „Save“.

Ersetzen der Kappen von Multifunktionstasten und -reglern

Das DaVinci Resolve Advanced Panel Keycap Upgrade Kit liefert auch Ersatztastenkappen für die Multifunktionstasten und -regler. Da diese Tastenkappen die Originale eins zu eins ersetzen, ist ihre Anbringung optional. Sie bieten einen praktischen Ersatz für abgenutzte Originalkappen.

Ersetzen der Kappen von Multifunktionstasten

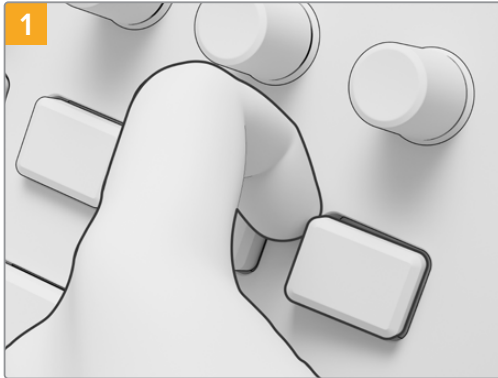

Um die Kappe einer Multifunktionstaste zu entfernen, ziehen Sie die Kappe behutsam an einer Ecke hoch, bis sie sich aus der Halterung löst.

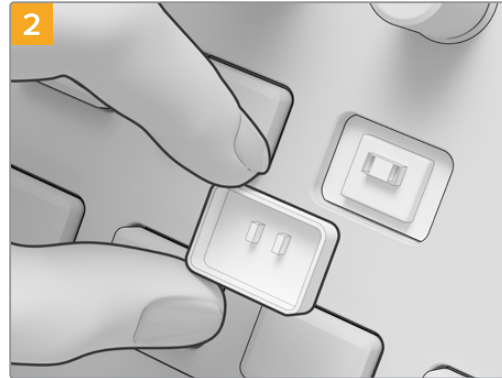

Achten Sie beim Anbringen einer Ersatzkappe an eine Multifunktionstaste darauf, dass die beiden Zapfen an der Innenseite der Kappe auf die Aussparungen in der Halterung ausgerichtet sind. Die Zapfen liegen etwas über der Mitte. Drücken Sie die Kappe an, bis sie hörbar einrastet.

Ersetzen der Kappen von Multifunktionsreglern

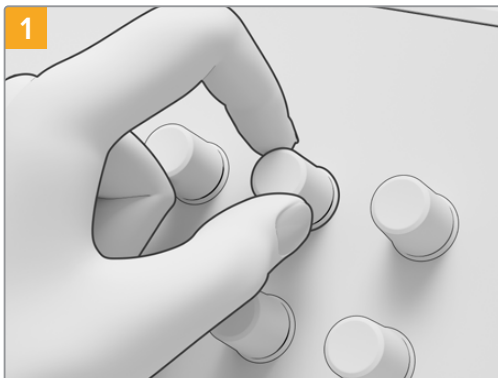

Entfernen Sie die Kappe eines Multifunktionsreglers, indem Sie sie fest mit Zeigefinger und Daumen ergreifen und sie von ihrer Spindelhalterung abziehen.

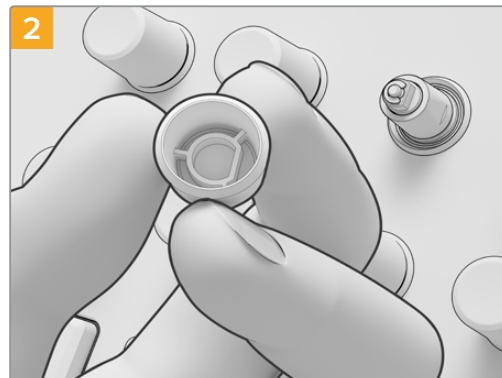

Richten Sie den D-förmigen Einsatz zum Anbringen der Kappe des Multifunktionsreglers auf die Oberseite der Spindel aus.

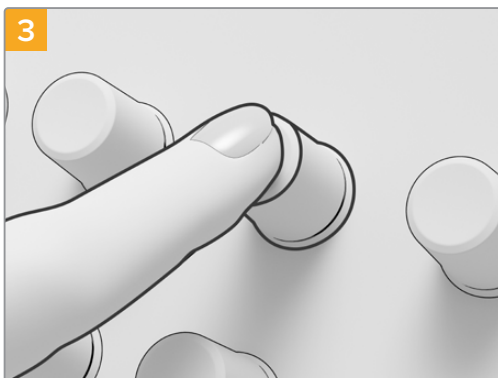

Drücken Sie die Kappe auf die Spindel, bis sie fluchtrecht mit dem unteren Teil der Spindel ist.

Anordnung der Tastenkappen nach Modulen

Die Modullayouts in diesem Abschnitt zeigen die Anordnung jeder einzelnen Taste auf den drei Panelmodulen. Ziehen Sie beim Anbringen der einzelnen Keycaps auf Ihrem Advanced Panel diese Layouts zu Rate.

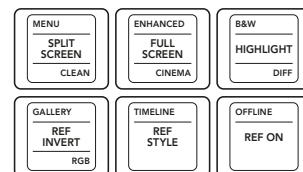
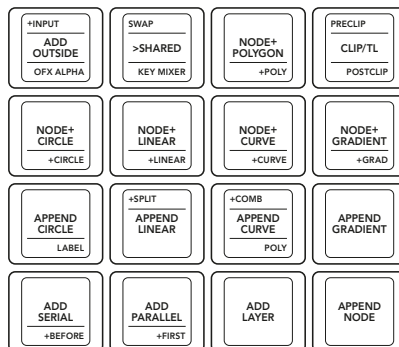
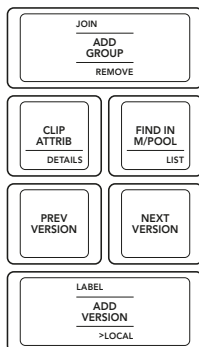
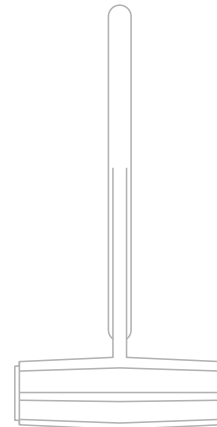
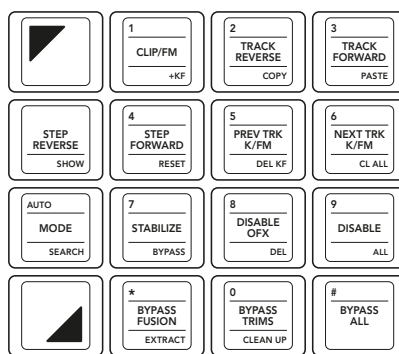
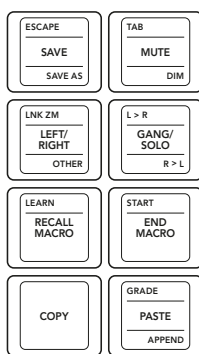
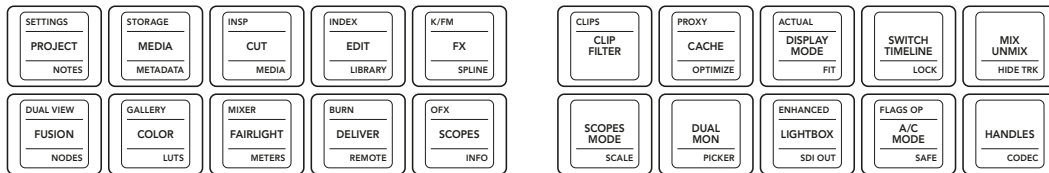

T-bar Panel

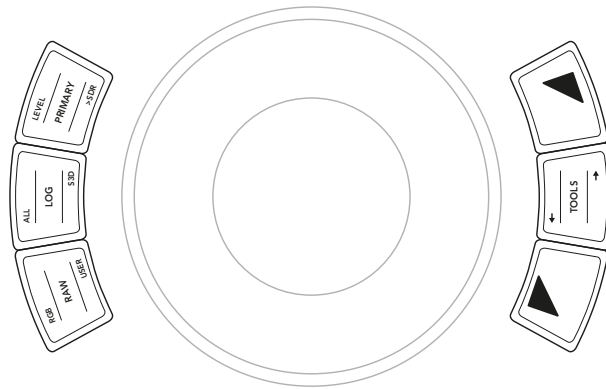
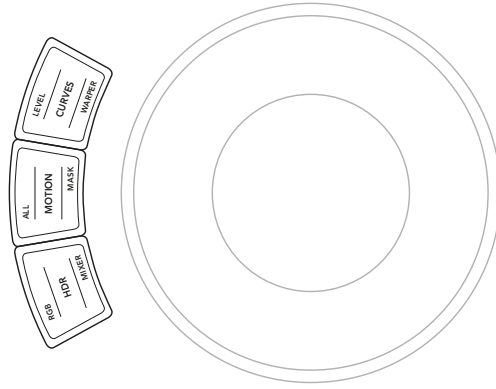
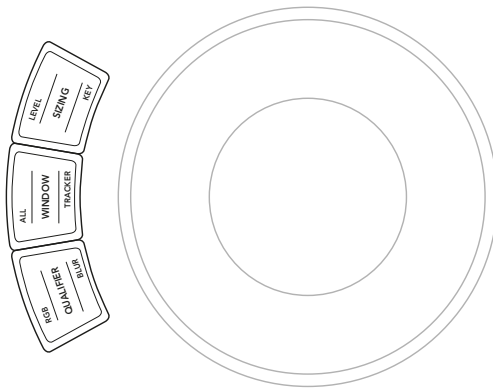
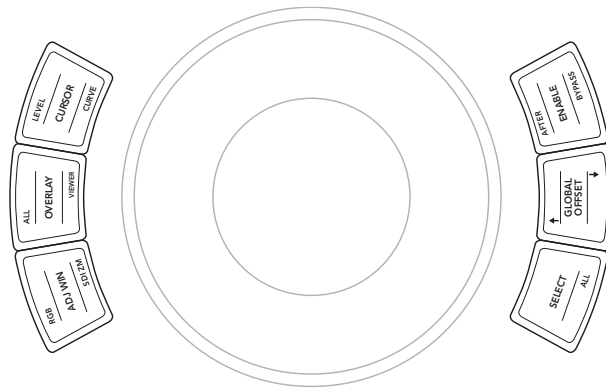

Trackball Panel

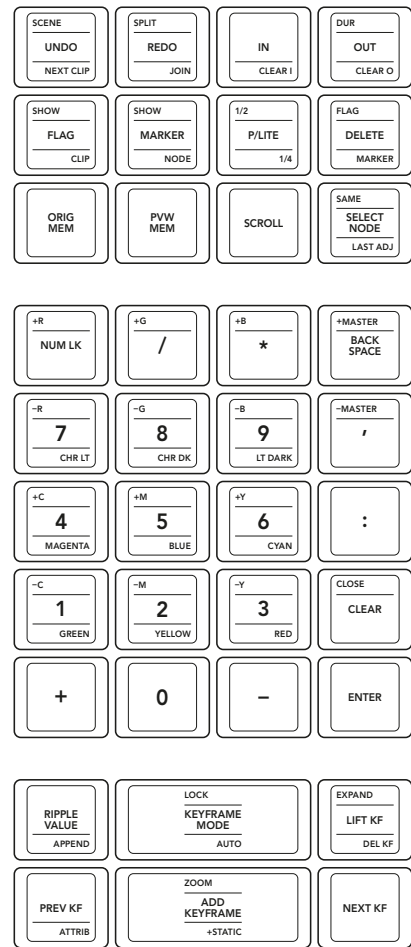
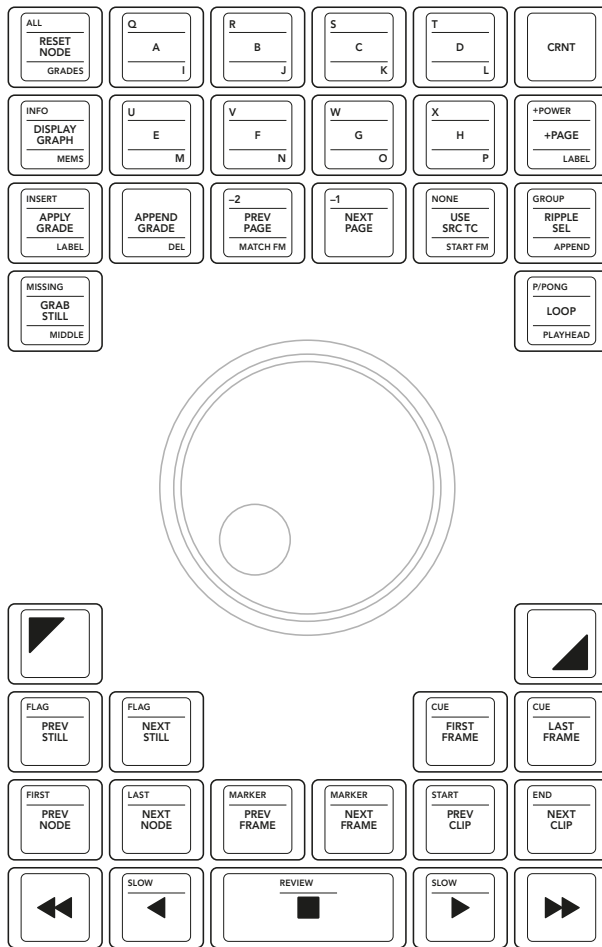

Search Dial Panel

DaVinci Advanced Panel Keycaps



Índice

DaVinci Advanced Panel Keycaps	40
Retirar las teclas del panel	41
Instalación de las nuevas teclas en el panel	42
Reemplazo de botones y mandos giratorios	42
Organización de las teclas	44

DaVinci Advanced Panel Keycaps

Este accesorio permite actualizar el dispositivo DaVinci Advanced Panel para aprovechar al máximo todas las funciones de DaVinci Resolve 17.

El kit de teclas está compuesto por tres láminas de plástico que contienen todas las funciones necesarias para cada módulo del dispositivo. Asimismo, incluye la herramienta necesaria para sustituir las teclas originales fácil y rápidamente.

Esta guía brinda instrucciones para reemplazar las teclas en el dispositivo DaVinci Advanced Panel.

El panel avanzado se encuentra dividido en tres módulos.



1. Módulo con palanca 2. Módulo con esferas 3. Módulo con mando de búsqueda

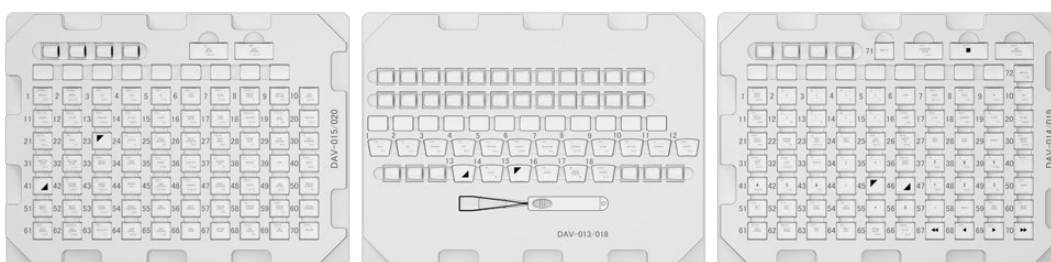

El kit de teclas consta de tres láminas.

NOTA: Antes de comenzar a retirar las teclas originales, desconecte el panel de la fuente de alimentación. Es recomendable llevar esto a cabo en un espacio bien iluminado. Asimismo, recomendamos contar con un recipiente en el que pueda almacenar las teclas originales.

Retirar las teclas del panel

Las teclas del panel están colocadas sobre una pequeña montura de plástico que las mantiene en la posición correcta.

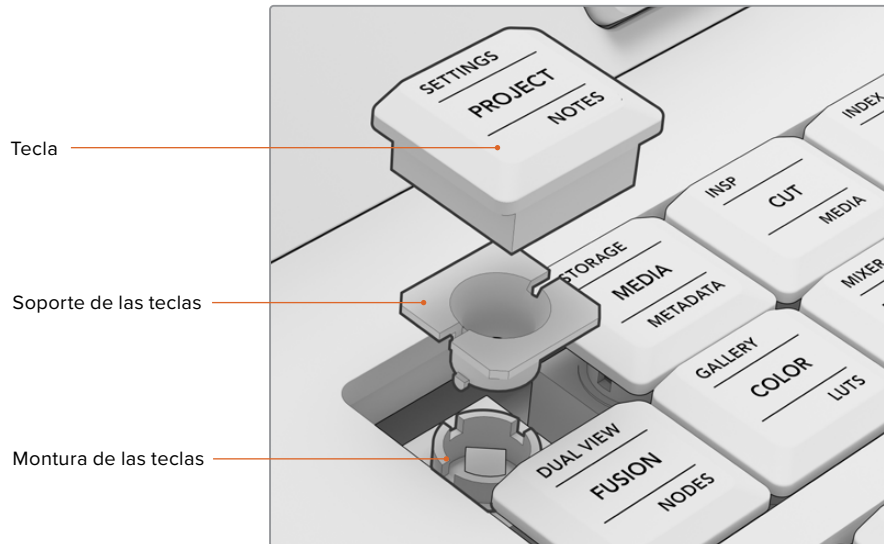

Disposición de las teclas y la montura

Para retirar una tecla:

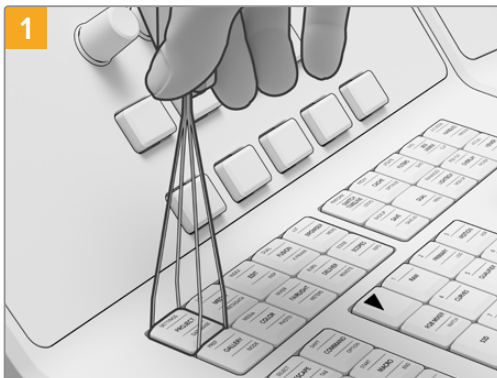

Coloque la herramienta incluida sobre la tecla de manera que los bordes cubran cada lado.

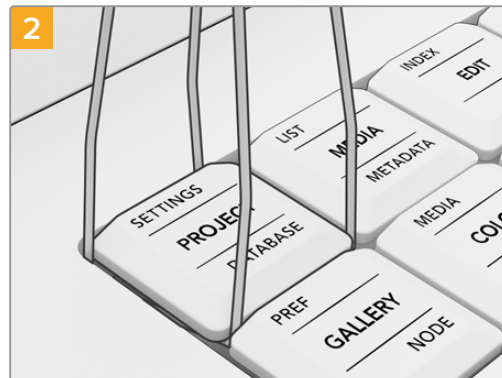

Gire levemente la herramienta hacia un lado, a fin de que los extremos queden debajo de las esquinas de la tecla.

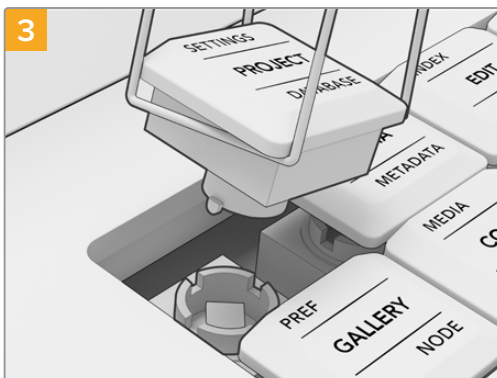

Mantenga la herramienta en un ángulo recto con respecto al panel y tire hacia arriba con suavidad hasta desmontar la tecla.

NOTA: En ocasiones, puede que, al retirar una tecla, la pieza blanca sobre la que está montada quede en el panel. Si esto ocurre, continúe el proceso retirando otras teclas, a fin de contar con más espacio, y finalmente retire, usando los dedos, la pieza blanca atascada.

Una vez que todas las teclas originales han sido retiradas, es posible comenzar a instalar las nuevas.

Instalación de las nuevas teclas en el panel

Recomendamos instalar las teclas nuevas en cada módulo de manera independiente y con la lámina correspondiente. Asimismo, al llevar a cabo este proceso, consulte el apartado “Organización de las teclas en los paneles”, a fin de asignar cada tecla a su lugar correspondiente.

Para instalar las teclas:

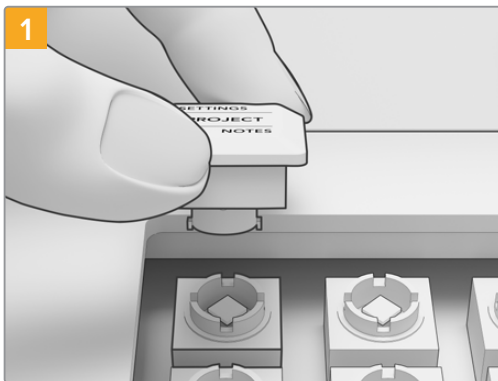

1 Mantenga el soporte de la tecla alineado con su montura en el panel. Las pestañas laterales de la tecla encajarán en el espacio de la montura.

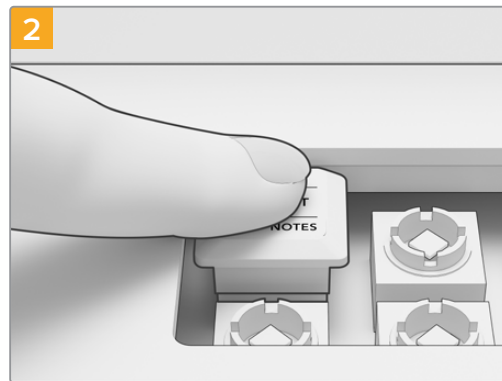

2 Presione cuidadosamente la tecla en la montura hasta que calce en su lugar.

Una vez terminada la instalación de las teclas en los tres módulos, vuelva a conectar el dispositivo a la fuente de alimentación y abra DaVinci Resolve 17. A continuación, puede configurar el programa de acuerdo con la versión actualizada de su panel

Para configurar el panel:

- 1 Seleccione la opción **Panel de control** en el menú **Preferencias**.
- 2 Seleccione **DaVinci Resolve Advanced Panel 2** en el menú **Paneles de etalonaje**.
- 3 Haga clic en **Guardar**.

Reemplazo de botones y mandos giratorios

Este kit de accesorios incluye asimismo repuestos para los botones y los mandos giratorios. No obstante, no es necesario reemplazarlos, ya que son exactamente iguales, aunque son útiles en caso de que los originales se hayan desgastado.

Reemplazar los botones

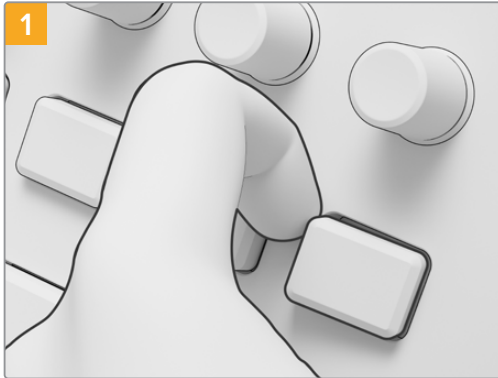

Para retirar un botón, tire suavemente de una de las esquinas hasta desmontarlo.

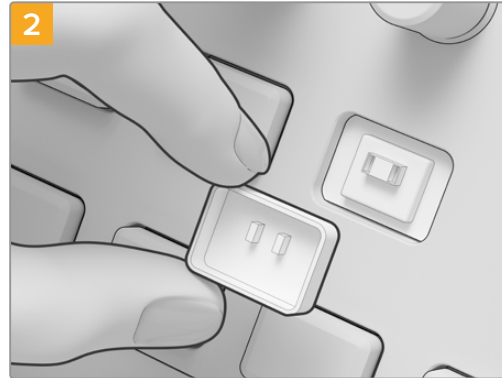

Para reemplazarlo, asegúrese de que las dos pequeñas pestañas en la parte trasera del repuesto están alineadas con las ranuras en la montura. Dichas pestañas están situadas encima del centro. Empuje la pieza hasta que calce en su lugar.

Reemplazar los mandos giratorios

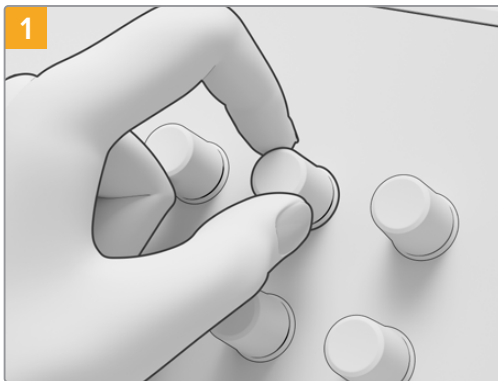

Para retirar los mandos giratorios, sujete uno con firmeza con los dedos y tire hacia el lado contrario de la montura giratoria.

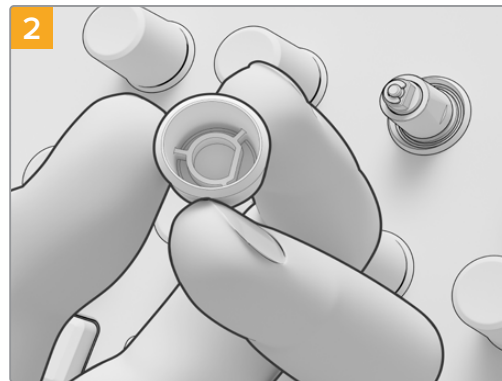

Para colocar uno nuevo, asegúrese de que la parte con forma de «D» del repuesto está alineada con la parte superior del eje giratorio.

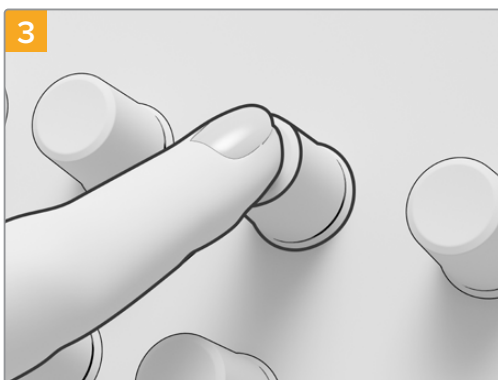

Empuje el repuesto hasta que esté alineado con la base del eje.

Organización de las teclas

Este apartado muestra la posición de cada botón en los tres módulos. Recomendamos consultarlo durante su instalación.

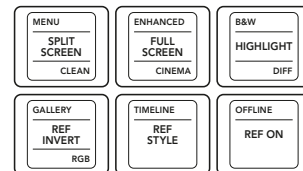
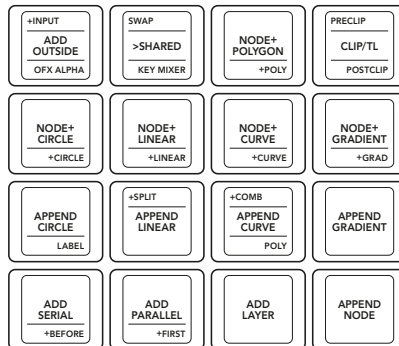
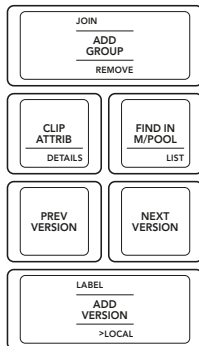
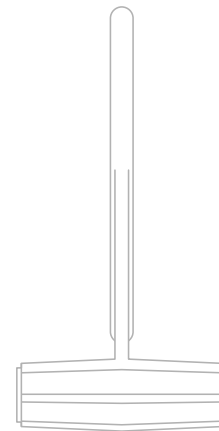
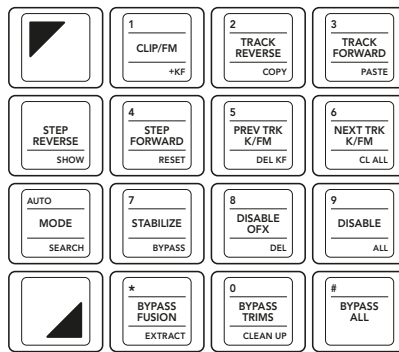
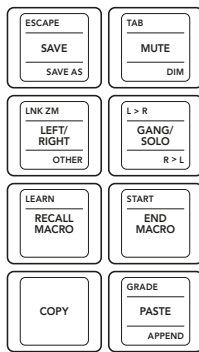
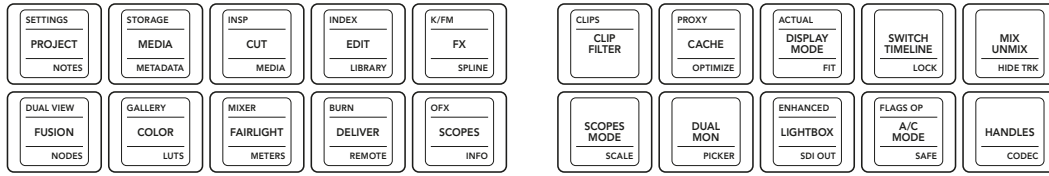

Módulo con palanca

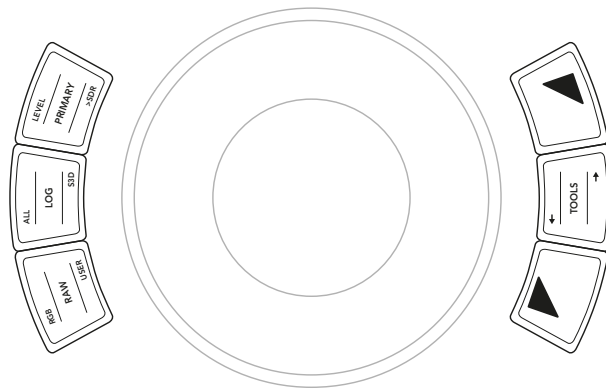
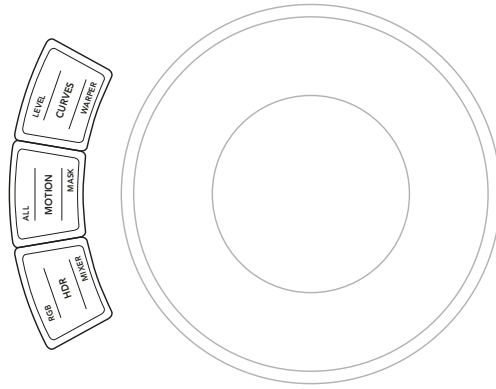
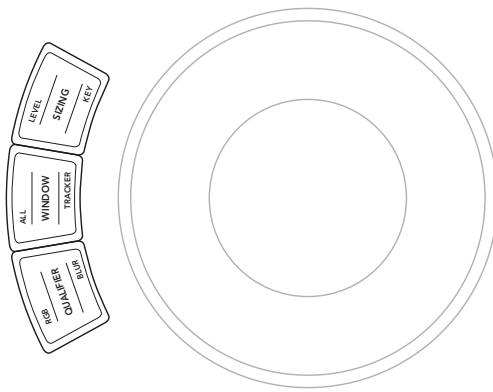
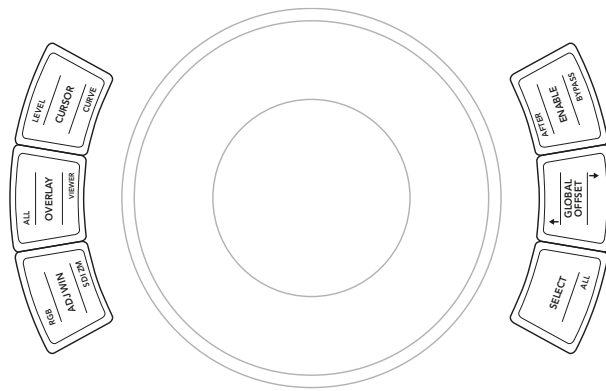

Módulo con esferas

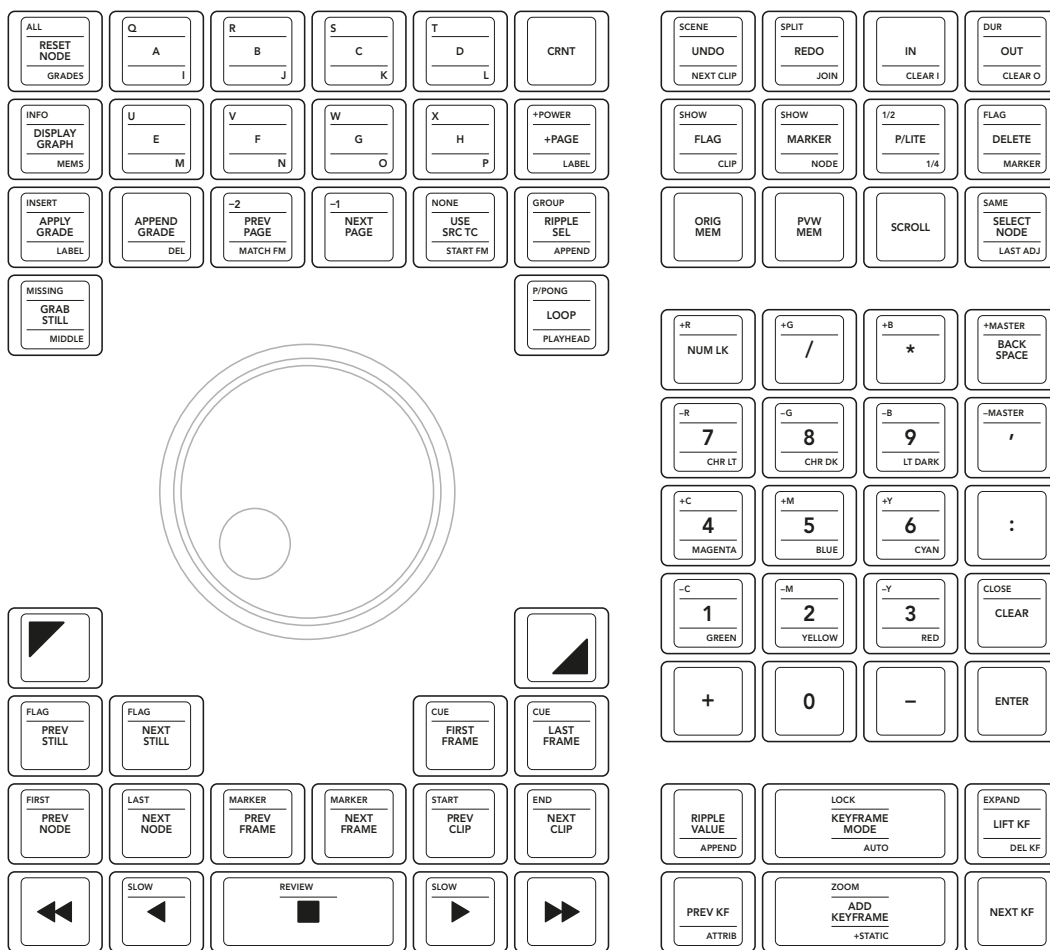

Módulo con mando de búsqueda

2021年3月
安装指南

Blackmagicdesign 

DaVinci Advanced Panel 键帽



DaVinci Advanced Panel 键帽
引领创意视频革命

中文

目录

DaVinci Advanced Panel键帽	49
从调色台上移除键帽	50
为调色台安装新的键帽	51
替换多功能按键和多功能旋钮键帽	51
键帽模块布局	53

DaVinci Advanced Panel键帽

请阅读本《DaVinci Advanced Panel键帽升级》来升级您的Advanced Panel调色台,从而充分利用DaVinci Resolve 17的所有功能。

这一键帽升级包提供了三个塑料包装的键帽收纳盘,里面包含Advanced Panel调色台各个模块所需的全部替换键帽。本升级包还提供了键帽拔键器,可快速便捷地卸下原装键帽。

本操作指南向您展示了如何移除并替换DaVinci Advanced Panel调色台上的键帽。

Advanced Panel调色台共分为三个模块。



1. T型杆面板 2. 轨迹球面板 3. 搜索旋钮面板



键帽升级包一共分三个收纳盘。

备注 移除原装键帽前,请先断开Advanced Panel调色台的电源。请在明亮的工作环境下进行操作,并准备好用来存放原装键帽的容器。

从调色台上移除键帽

调色台上的键帽是固定在一个小型塑料阀杆上的, 为的是让按键通过这个阀杆固定位置。

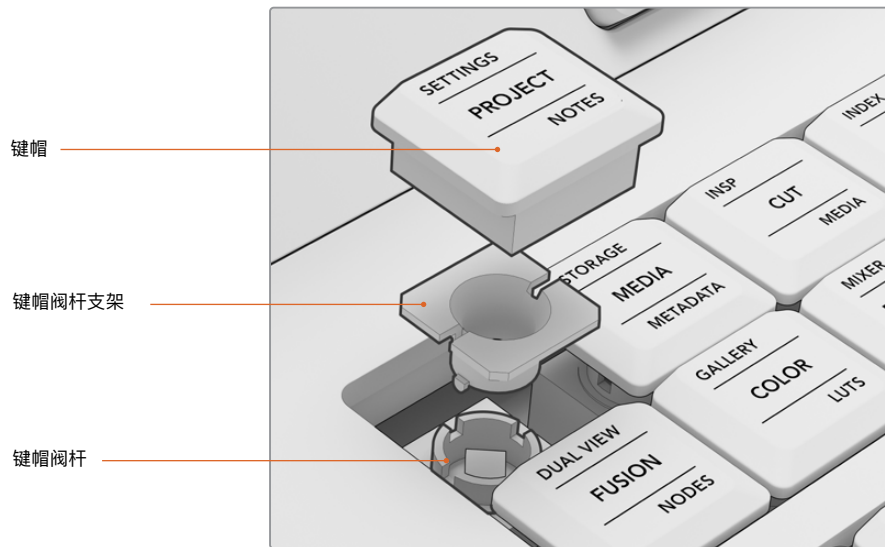

键帽和键帽阀杆结构图

移除键帽

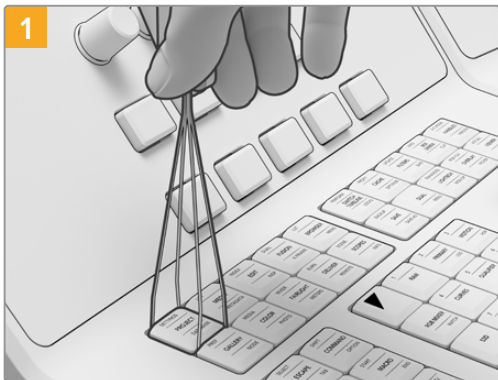

1 将键帽拔键器放入键帽边缘的缝隙。

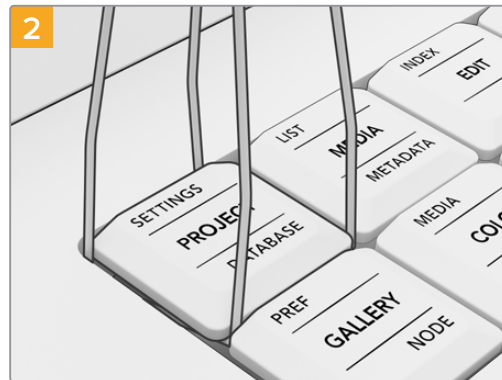

2 向一侧轻轻旋转拔键器, 使其卡入键帽底部。

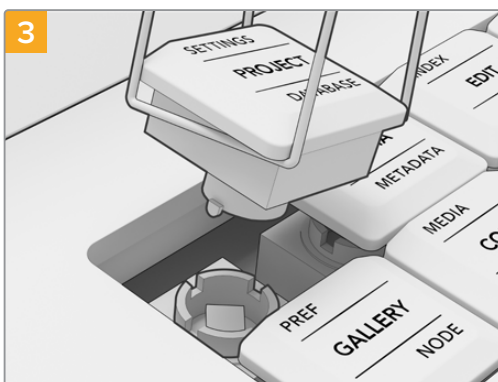

3 将拔键器和调色台保持在正确角度, 然后小心向上提起, 直至键帽从阀杆上剥离。

备注 有些情况下, 在移除键帽时您可能会发现键帽的白色阀杆支架会从键帽分离, 留在调色台面板内。如遇此类情况, 请继续移除周围的键帽腾出空间, 然后用手指移除面板内的键帽阀杆支架。

从Advanced Panel调色台上移除所有原装键帽后, 就可以安装升级包中的键帽了。

为调色台安装新的键帽

安装新的键帽时, 建议最好使用每个调色台模块所对应的键帽收纳盘, 对不同模块分开进行更换。安装键帽时, 请参考本手册后续内容“键帽模块布局”部分的介绍, 将每个键帽安装到其指定的键帽阀杆上。

安装键帽

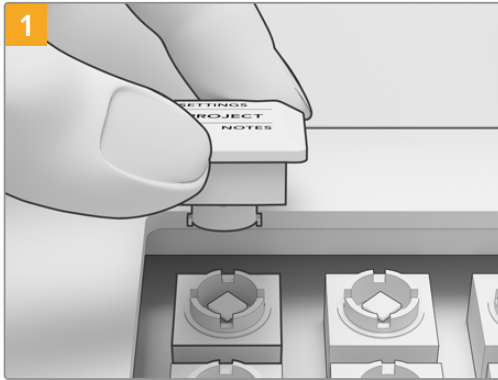

将键帽阀杆的支架与调色台内的键帽阀杆对齐。键帽阀杆支架两侧的凸起设计对应键帽阀杆的凹槽。

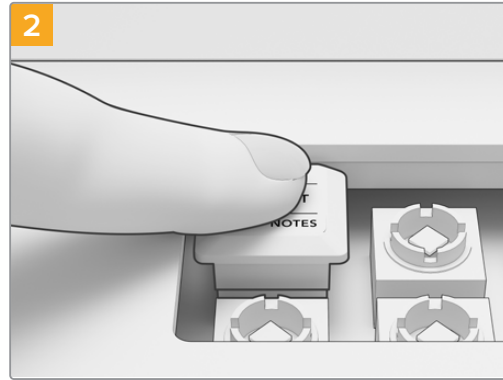

将键帽轻轻推入阀杆内。听见咔哒声后, 键帽应已扣入到位。

为Advanced Panel调色台三个模块上的所有键帽完成替换后, 重新链接电源, 并运行DaVinci Resolve 17。然后, 在DaVinci Resolve中为新的调色台进行配置。

配置调色台:

- 1 进入“偏好设置” > “控制面板”。
- 2 到“调色台”菜单中, 选择“DaVinci Resolve Advanced Panel 2”。
- 3 点击“保存”。

替换多功能按键和多功能旋钮键帽

本DaVinci Resolve Advanced Panel键帽升级包还提供替换的多功能按键和多功能按钮键帽。这些键帽是原装键帽的替换装, 请根据需要选用。如果原装键帽出现磨损, 可以用这些键帽作为替换。

替换多功能键帽

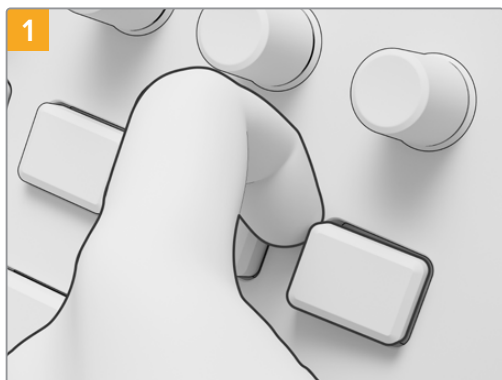

1 移除多功能按键时，轻轻掀起键帽一角，直至键帽从其阀杆上剥离。

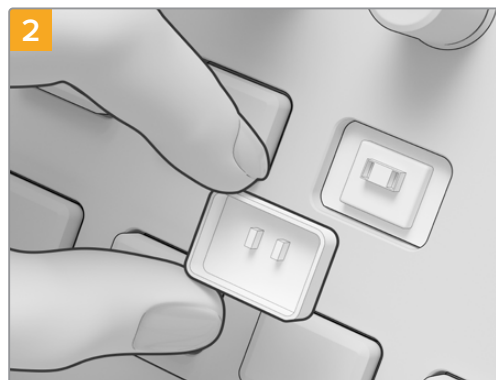

2 安装多功能按键的替换键帽时，请确保键帽后侧的两个小型凸起设计与阀杆上的凹槽对齐。这两个凸起设计位于键帽后侧中心偏上的位置。将键帽向里按压，直至听到咔哒声固定到位。

替换多功能旋钮键帽

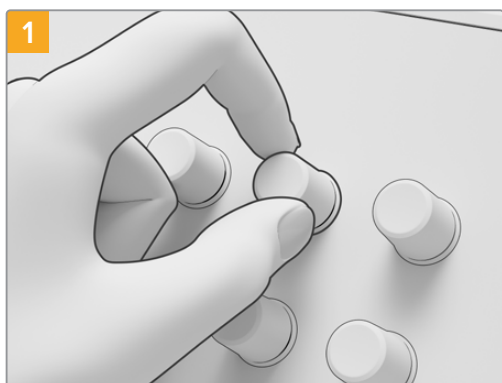

1 移除多功能旋钮键帽时，用食指和拇指握紧键帽，将其从转轴卡口拔出。

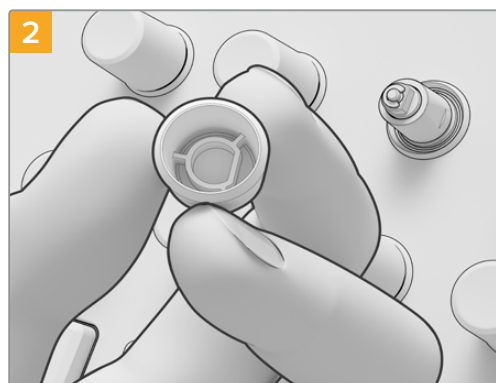

2 安装多功能旋钮的替换键帽时，将键帽内的“D”形设计与转轴顶部对齐。

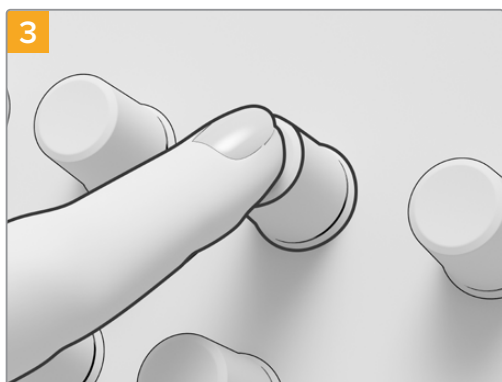

3 将键帽向转轴按压，直至键帽边缘与转轴底部齐平。

键帽模块布局

这一部分的模块布局示意图展示了调色台三个面板模块上每个按键的位置。为Advanced Panel调色台安装键帽时,可以参考这一部分的介绍。

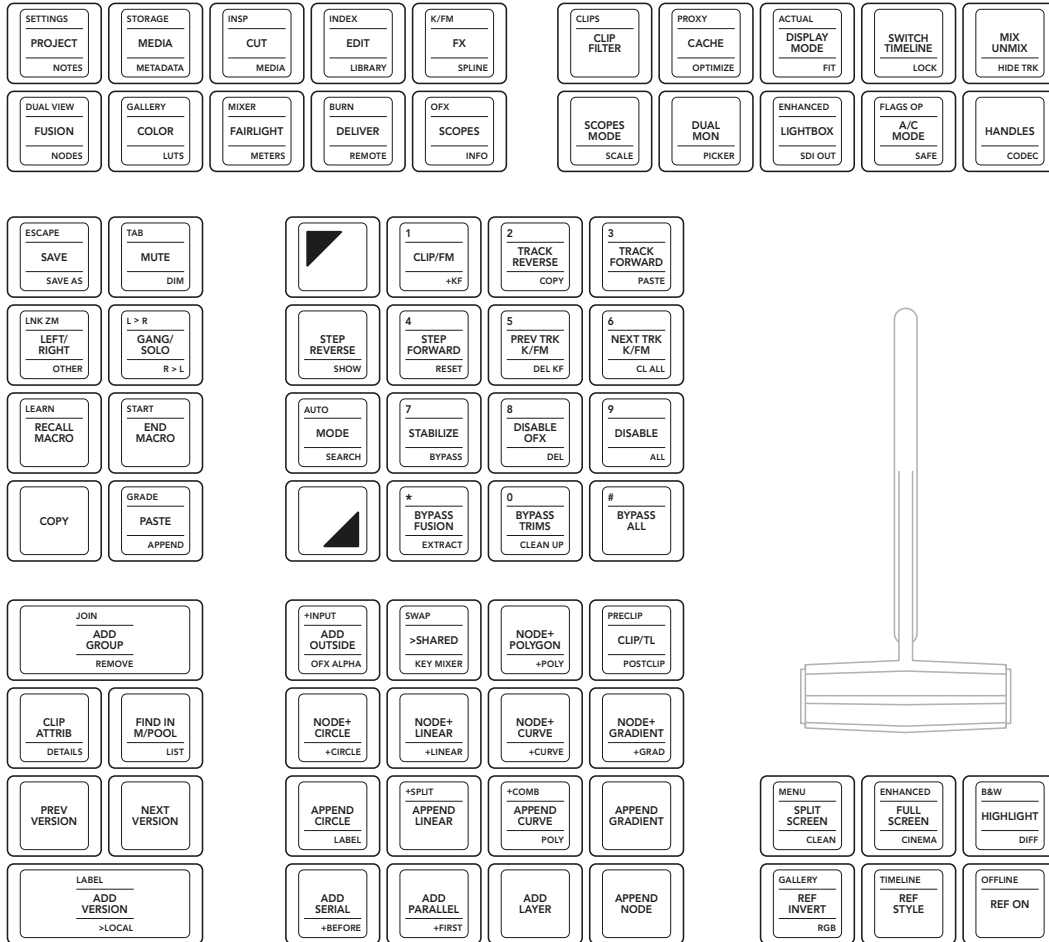

T型杆面板

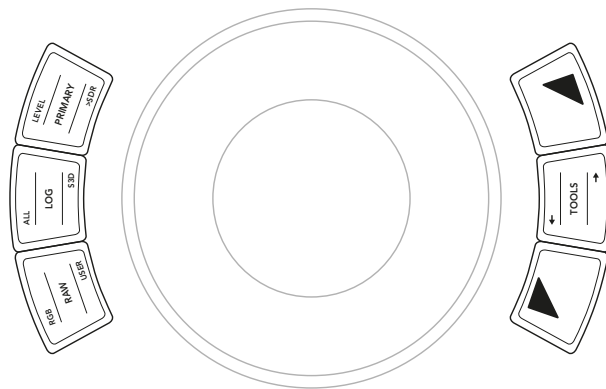
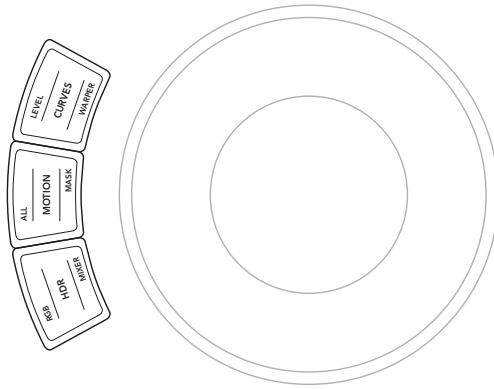
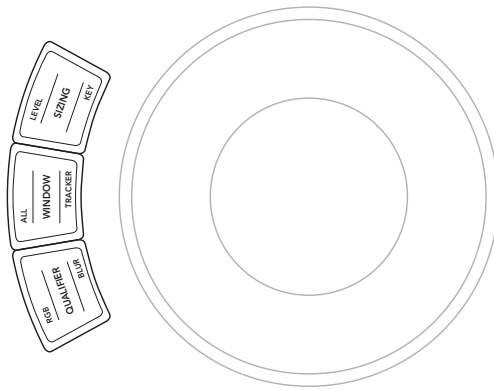
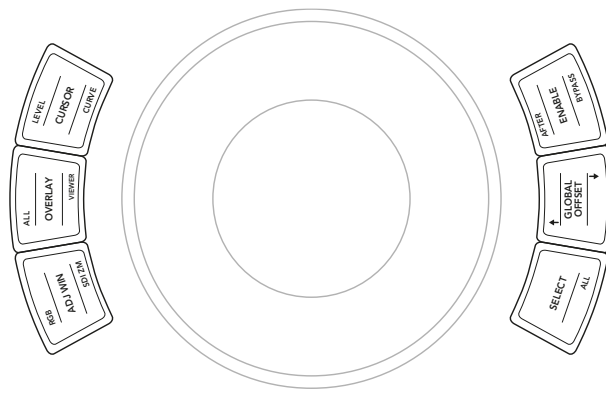

轨迹球面板

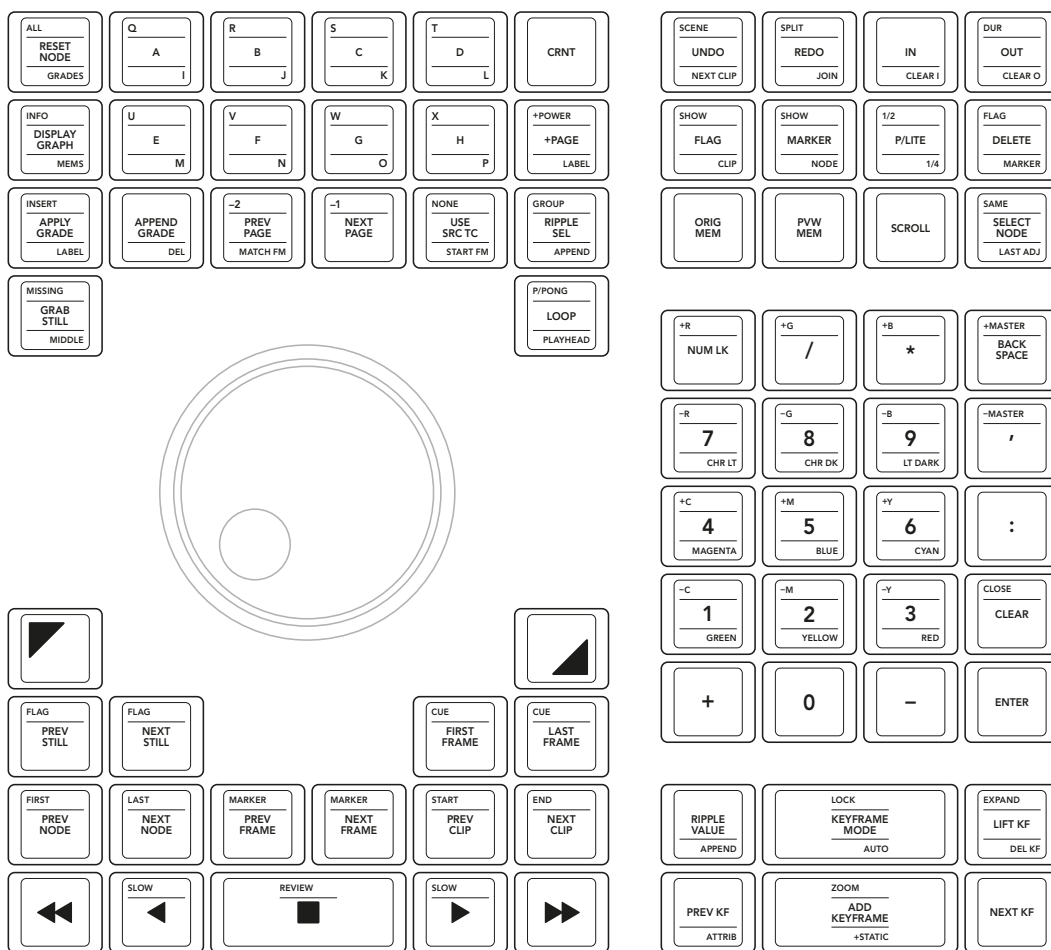

搜索旋钮面板

DaVinci Advanced Panel Keycaps



DaVinci Advanced Panel Keycaps

창의적인 비디오 산업 혁명을 이끄는 기업

한국어

목차

DaVinci Advanced Panel Keycaps Upgrade	58
패널에서 키캡 제거하기	59
패널에 새로운 키캡 설치하기	60
소프트 키 및 소프트 노브 캡 교체하기	60
키캡 모듈 레이아웃	62

DaVinci Advanced Panel Keycaps Upgrade

DaVinci Advanced Panel Keycaps Upgrade를 사용하면 DaVinci Resolve 17의 모든 기능을 완벽하게 활용할 수 있도록 Advanced Panel을 업그레이드할 수 있습니다.

키캡 업그레이드 키트는 세 개의 플라스틱 패키지를 제공하며, 여기엔 각 Advanced Panel 모듈에 필요한 모든 교체용 키캡이 들어있습니다. 키캡 제거 도구도 포함되어 있어 기존에 설치된 키캡을 쉽고 빠르게 제거할 수 있습니다.

이 제품 가이드에는 DaVinci Advanced Panel의 키캡 제거 및 교체 방법이 소개되어 있습니다.

Advanced Panel은 세 개의 모듈로 구성되어 있습니다.



1. T바 패널 2. 트랙볼 패널 3. 검색 다이얼 패널



키캡 업그레이드 키트에는 세 개의 패키지가 포함되어 있습니다.

참고 기존 키캡을 제거하기 전에 Advanced Panel의 전원 연결을 해제하세요. 빛이 잘 드는 곳에서 작업하는 것이 좋으며, 기존 키캡을 따로 보관할 용기를 준비하는 것도 좋습니다.

패널에서 키캡 제거하기

패널에 있는 키캡은 작은 플라스틱 마운트 위에 설치되어 있습니다. 이 마운트 위에 키캡을 꼽으면 제자리에 고정됩니다.

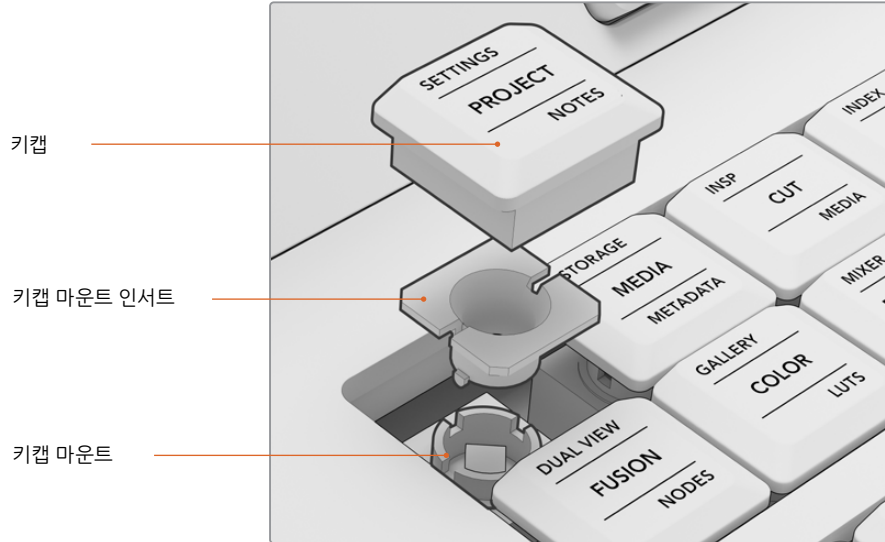

키캡 및 키캡 마운트의 구조

키캡 제거하기

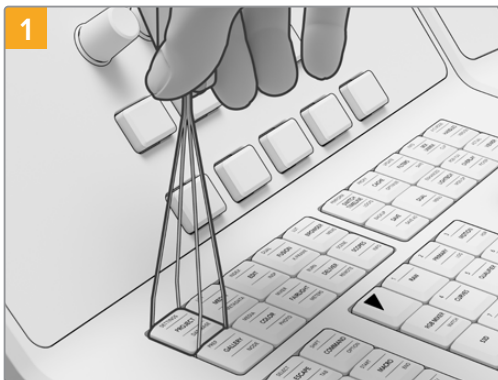

키캡 제거 도구의 끝부분이 키캡 양쪽 측면에 오도록 맞추세요.

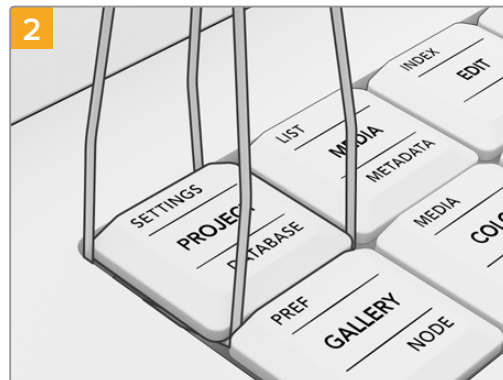

제거 도구를 살짝 돌려 끝부분이 키캡 모서리에 걸리도록 하세요.

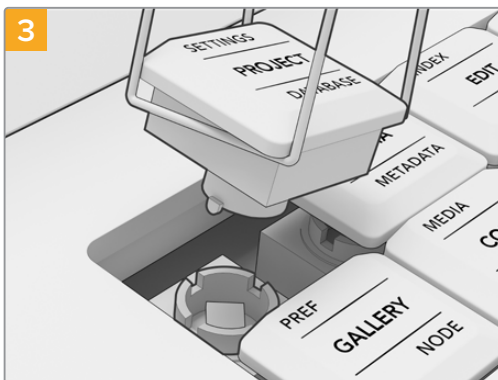

제거 도구를 패널 오른쪽으로 기울인 채 키캡이 마운트에서 빠질 때까지 부드럽게 들어 올리세요.

참고 키캡을 제거할 때 간혹 키캡의 흰색 마운트 인서트가 패널에 그대로 남아 있는 경우가 있을 수 있습니다. 이 경우, 해당 키 주변의 키캡을 제거해 공간을 확보한 다음 손가락으로 키캡 마운트 인서트를 패널에서 빼내세요.

Advanced Panel에서 기존 키캡을 모두 제거하고 나면 키캡 업그레이드 키트를 설치할 수 있습니다.

패널에 새로운 키캡 설치하기

새로운 키캡을 설치할 경우, 교체용 키캡 패키지에 해당하는 패널을 한 번에 하나씩 작업하는 것이 좋습니다. 각 키캡을 설치할 때 본 설명서의 [키캡 모듈 레이아웃] 부분을 참고해 각 키캡에 맞는 마운트를 확인하세요.

키캡 설치하기

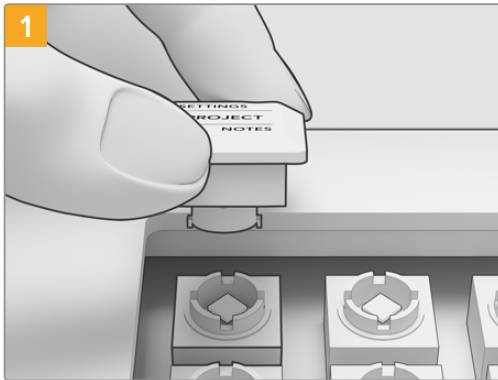

키캡의 마운트 인서트 부분을 패널에 있는 키캡 마운트에 맞추세요. 키캡 인서트 측면의 고리 부분이 키캡 마운트 홈에 꼭 맞게 장착됩니다.

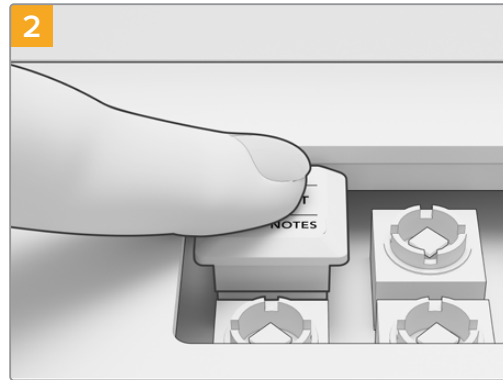

마운트 방향으로 키캡을 부드럽게 누르세요. 딸각하는 소리와 함께 손쉽게 장착됩니다.

Advanced Panel의 모든 구역에 교체용 키캡을 설치하고 나면, 전원을 연결하고 DaVinci Resolve 17을 실행하세요. 그런 다음, DaVinci Resolve에서 업그레이드한 패널의 환경 설정을 조정할 수 있습니다.

패널 환경 설정하기

- 1 'Preferences' > 'Control Panels'로 이동하세요.
- 2 'Color Grading Panel' 메뉴에서 'DaVinci Resolve Advanced Panel 2'를 선택하세요.
- 3 '저장(Save)' 버튼을 클릭하세요

소프트 키 및 소프트 노브 캡 교체하기

DaVinci Resolve Advanced Panel Keycap Upgrade에는 교체용 소프트 키 및 소프트 노브 캡도 포함되어 있습니다. 이는 기존 캡과 동일한 교체 부품이기 때문에 꼭 설치할 필요는 없습니다. 기존의 소프트 캡이 닳게 된 경우에 사용하기 좋습니다.

소프트 키캡 교체하기

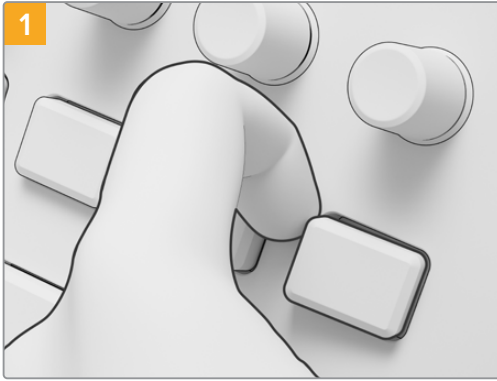

1
소프트 키를 제거하려면, 마운트에서 캡이 빠질 때까지 한쪽 끝을 부드럽게 잡아당기세요.

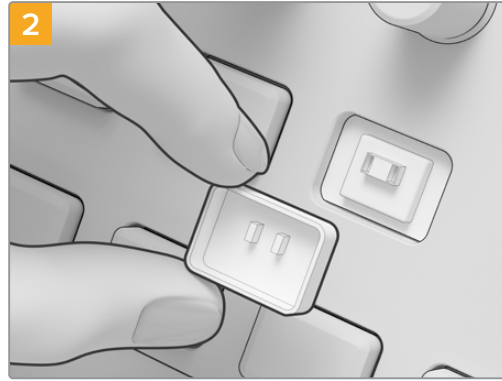

2
교체용 소프트 키캡을 끼우려면, 캡 뒤쪽에 있는 두 개의 작은 플라스틱 탭이 마운트의 슬롯과 일치하도록 정렬하세요. 이 탭은 키캡 중앙에서 약간 위쪽으로 배치되어 있습니다. 딸깍 소리가 날 때까지 캡을 누르세요.

소프트 노브 교체하기

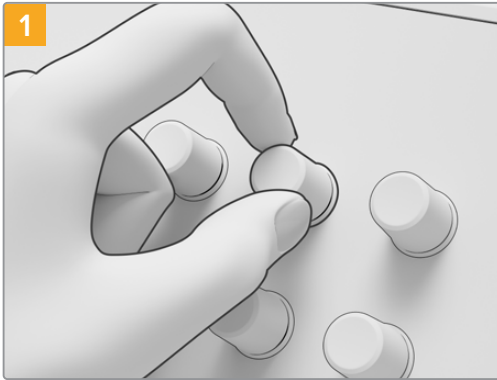

1
소프트 노브 캡을 제거하려면, 엄지와 검지로 캡을 꽉 잡은 다음 스피들 마운트로부터 떼어내세요.

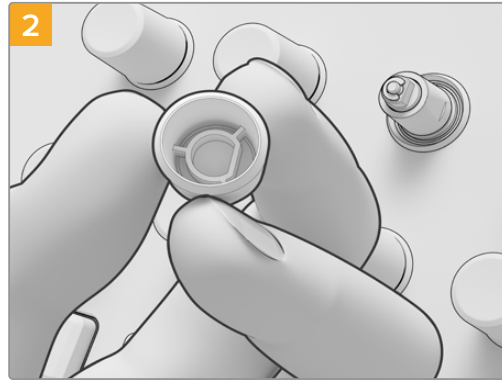

2
새로운 소프트 노브를 끼우려면, 캡에 있는 D 모양의 인서트 스피들 끝부분에 맞게 맞추세요.

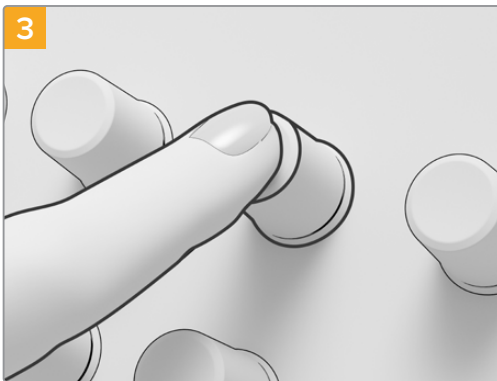

3
캡이 스피들의 베이스 높이와 같아질 때까지 누르세요.

키캡 모듈 레이아웃

아래의 모듈 레이아웃에는 세 개의 패널 모듈에 있는 각 버튼의 위치가 표시되어 있습니다. 키캡을 Advanced Panel에 설치할 경우, 이 레이아웃을 참고하세요.

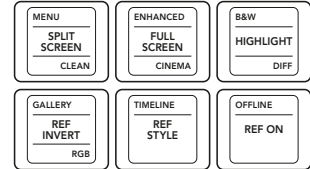
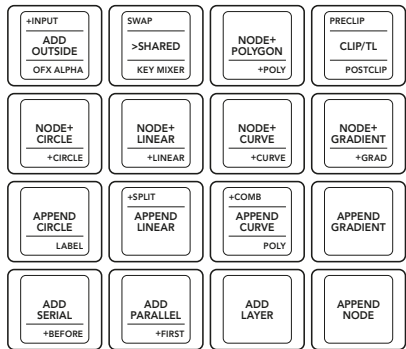
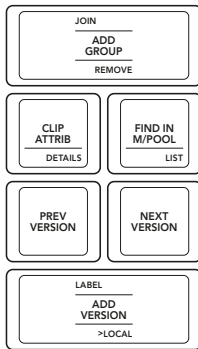
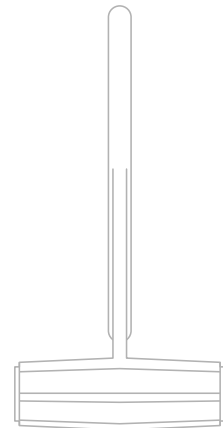
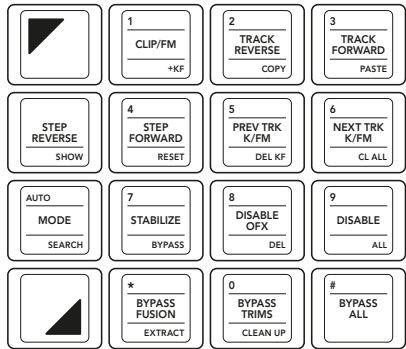
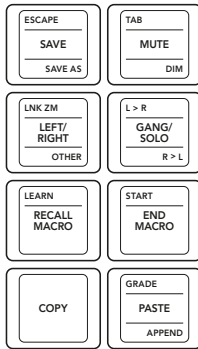
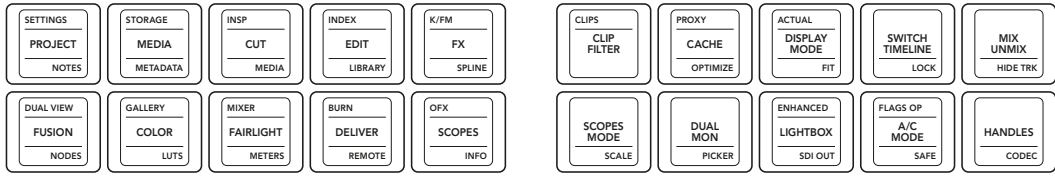

T바 패널

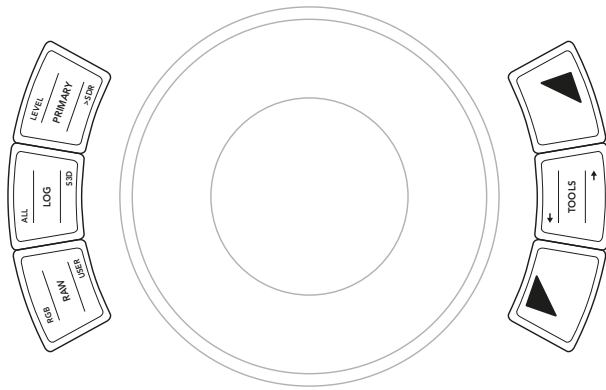
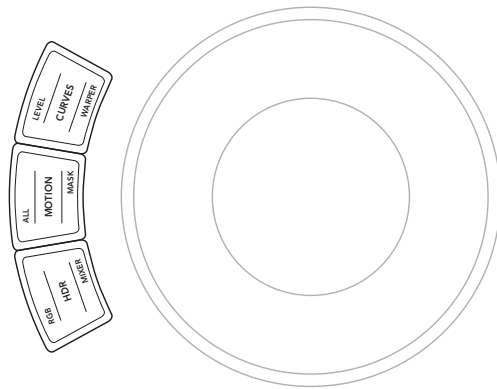
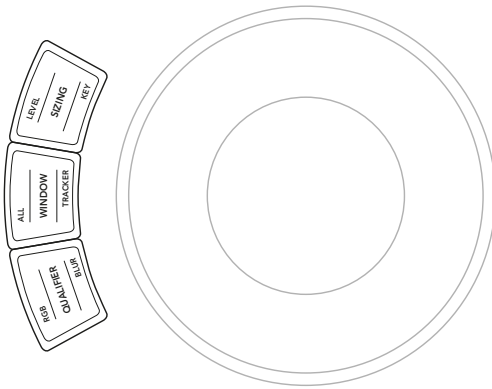
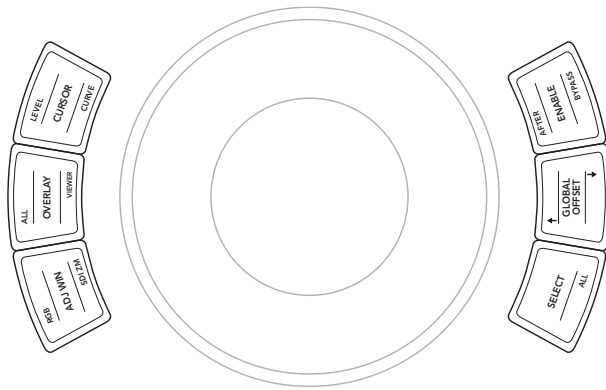

시퀀스 레이아웃

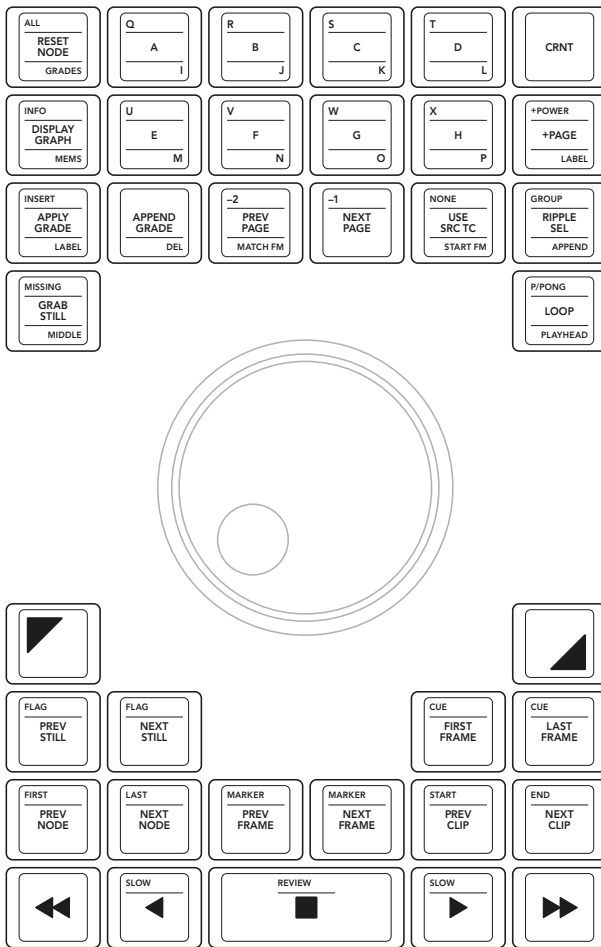

검색 다이얼 패널

Март 2021 г.

Руководство по установке

Blackmagicdesign 

Колпачки для пульта DaVinci Advanced Panel



Колпачки для пульта DaVinci Advanced Panel

Русский

Лидирующая роль в модернизации видеоиндустрии

Содержание

Новый комплект колпачков для пульта DaVinci Advanced Panel	67
Снятие колпачков с кнопок пульта	68
Установка новых колпачков	69
Замена программных клавиш и ручек	69
Расположение кнопок на модулях	71

Новый комплект колпачков для пульта DaVinci Advanced Panel

Новый комплект колпачков позволяет использовать пульт DaVinci Resolve Advanced Panel для работы с большим числом функций приложения DaVinci Resolve 17.

Комплект состоит из трех секций, каждая из которых содержит полный набор колпачков для отдельных модулей пульта. В комплект также входит специальный инструмент для снятия оригинальных колпачков.

В данном руководстве приводится описание снятия и замены кнопок пульта DaVinci Resolve Advanced Panel.

Пульт состоит из трех модулей.



1. T-bar panel 2. Trackball panel 3. Search Dial panel

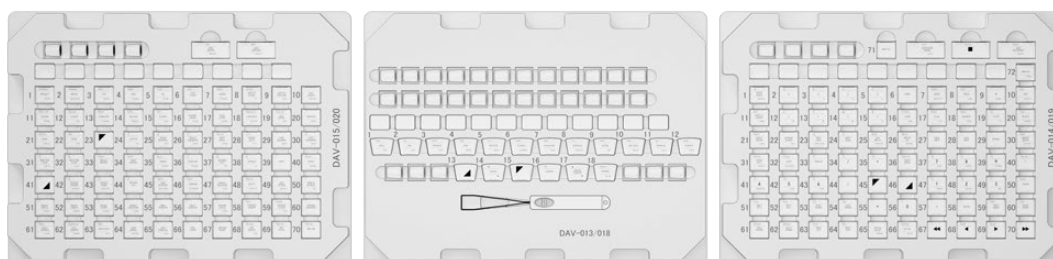

Новый комплект колпачков состоит из трех секций

ПРИМЕЧАНИЕ. Прежде чем приступить к снятию оригинальных колпачков, отключите пульт от сети электропитания. Рекомендуем работать в хорошо освещенном помещении и складывать снятые колпачки в отдельную коробку.

Снятие колпачков с кнопок пульта

Колпачки кнопок пульта насажены на специальные держатели, которые вставлены в маленькие пластиковые крепления.

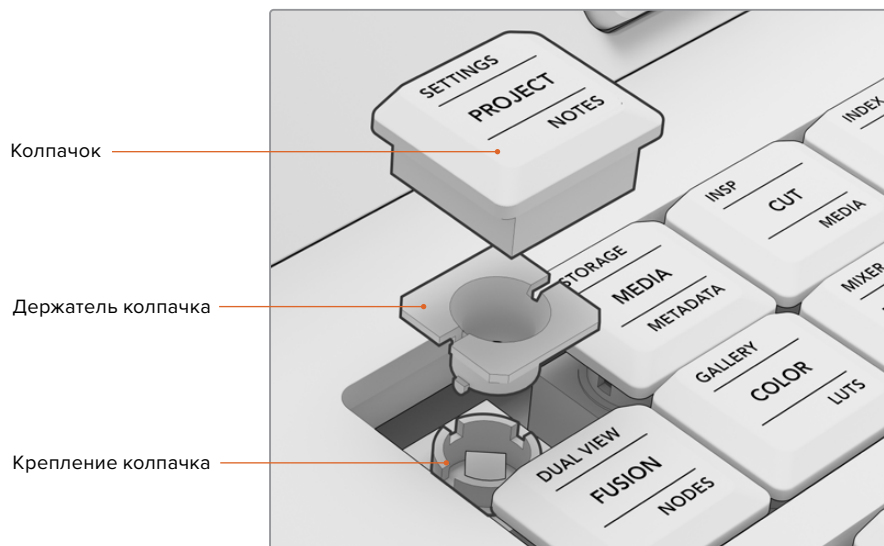

Конструкция крепления колпачка

Порядок снятия колпачка

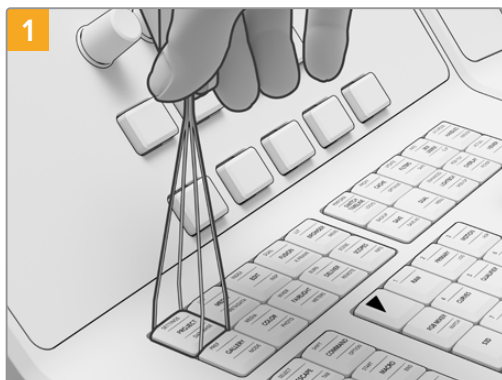

1 Вставьте инструмент для снятия в зазоры с обеих сторон колпачка.

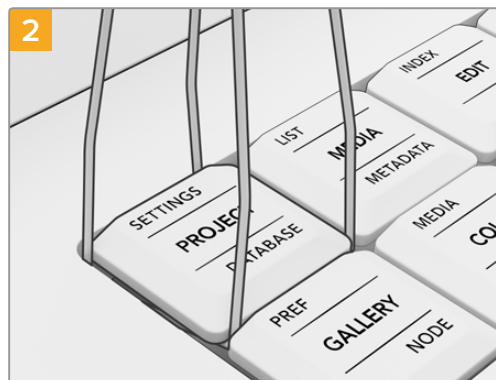

2 Поверните немного инструмент, чтобы петли зашли под углы колпачка.

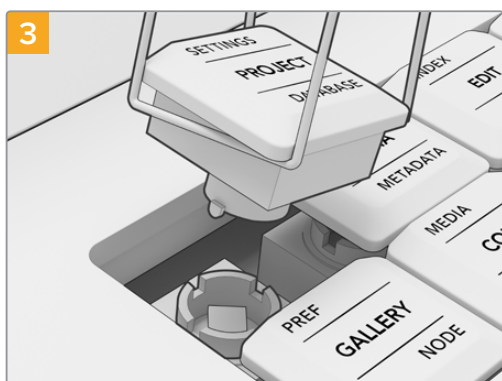

3 Удерживая инструмент под прямым углом к пульта, осторожно потяните вверх, чтобы колпачок отсоединился от крепления.

ПРИМЕЧАНИЕ. Иногда при снятии колпачка его держатель остается в креплении. Если это произойдет, снимите соседние колпачки, а затем пальцами вытяните держатель из крепления.

Приступать к установке колпачков из нового комплекта следует после снятия всех оригинальных кнопок.

Установка новых колпачков

Рекомендуется устанавливать колпачки на каждый модуль по отдельности и внимательно выбирать нужный набор. При выполнении операций руководствуйтесь схемами, приведенными в разделе «Расположение кнопок на модулях».

Порядок установки колпачка

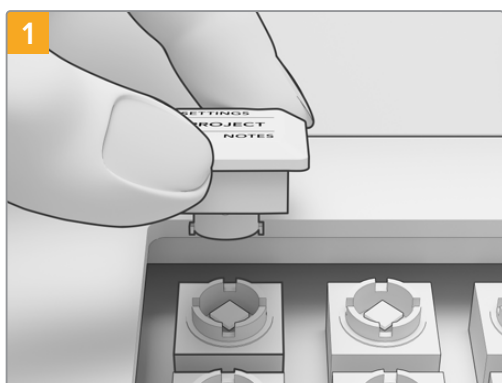

1 Совместите держатель колпачка с креплением. Боковые выступы держателя должны войти в пазы на креплении.

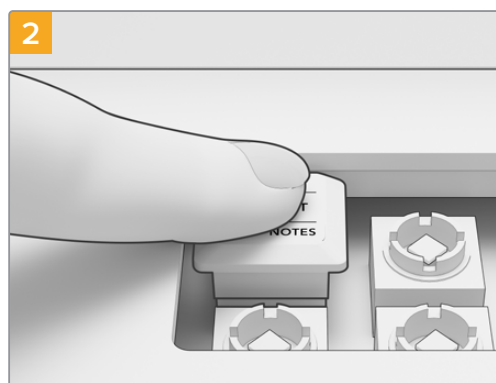

2 Осторожно вставьте держатель с колпачком в крепление. Он должен войти легко и зафиксироваться со щелчком.

По завершении замены колпачков на всех трех модулях подключите пульт к сети электропитания и откройте приложение DaVinci Resolve 17. В нем необходимо поменять настройки для обновленного пульта.

Выбор конфигурации для пульта

- 1 Перейдите в «Настройки» > «Панели управления».
- 2 В секции «Пульт для цветового грейдинга» выберите DaVinci Resolve Advanced Panel 2.
- 3 Нажмите «Сохранить».

Замена программных клавиш и ручек

В новый комплект колпачков для кнопок пульта DaVinci Resolve Advanced Panel также входят программные клавиши и круглые ручки. Они не отличаются от оригинальных компонентов и обычно используются только для замены износившихся деталей.

Замена программных клавиш

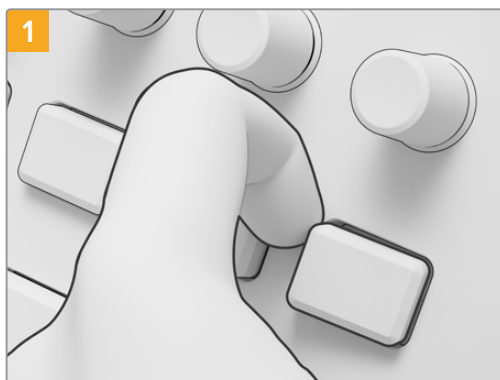

1
Чтобы снять программную клавишу, подденьте ее за угол и отсоедините от крепления.

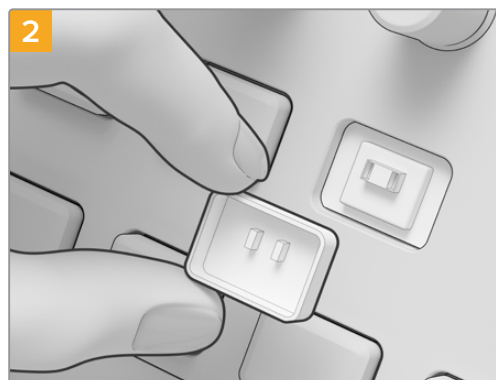

2
При установке новой клавиши совместите два небольших пластиковых выступа на тыльной стороне колпачка с пазами на креплении. Выступы расположены чуть выше центра. Поместите колпачок на крепление и надавите до щелчка.

Замена программных ручек

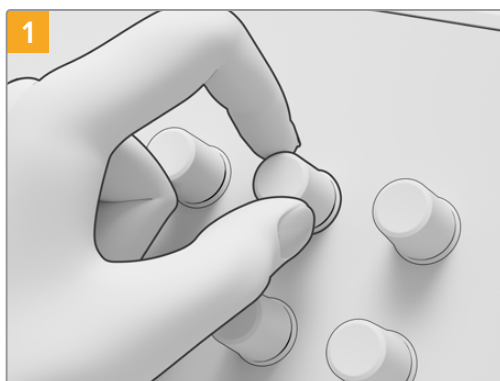

1
Для снятия программной ручки крепко возьмитесь за нее пальцами и потяните, чтобы отсоединить от крепежного стержня.

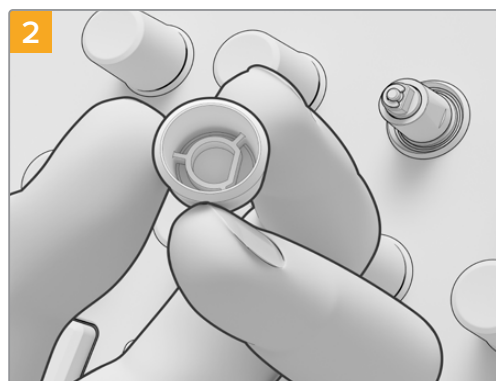

2
Чтобы установить новую ручку, совместите D-образное отверстие ручки с верхней частью стержня.

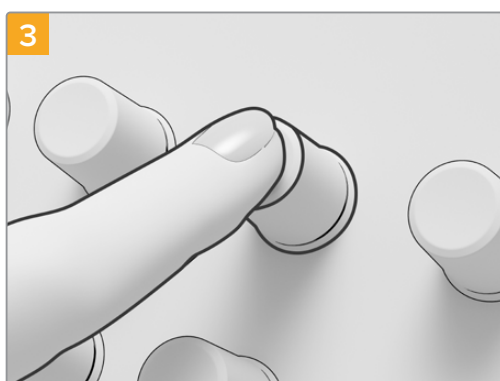

3
Надавите на ручку, чтобы она дошла до основания стержня.

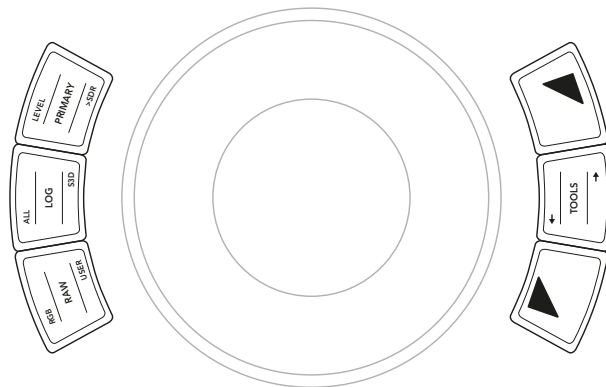
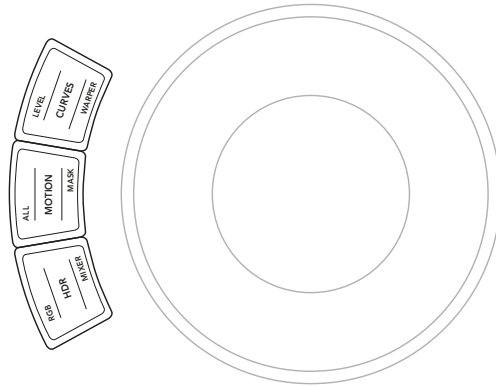
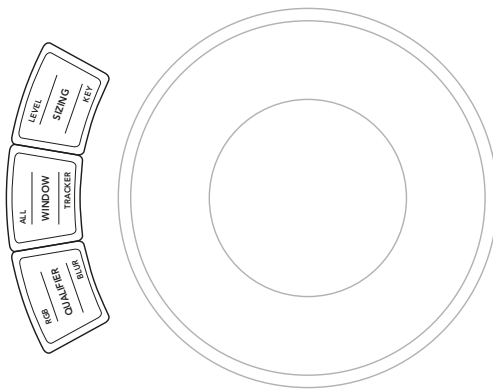
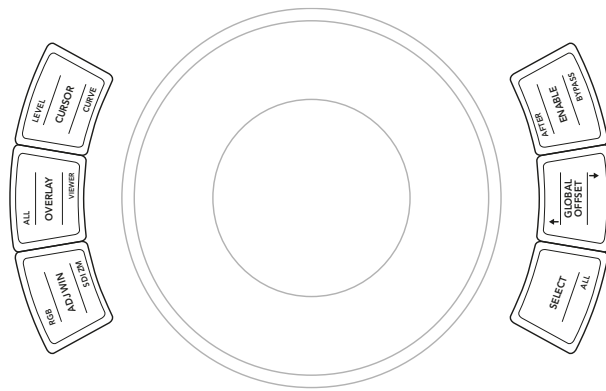

Trackball Panel

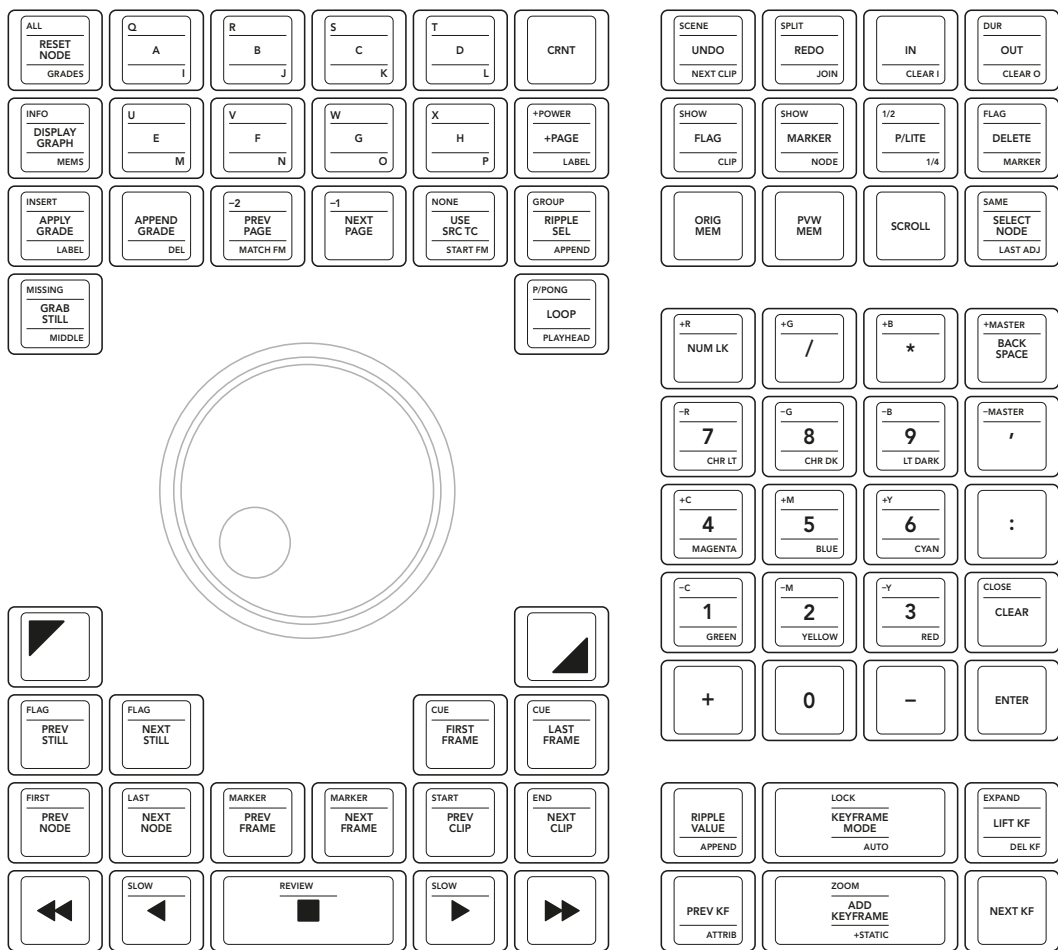

SearchDial Panel

Pulsanti per DaVinci Advanced Panel



Pulsanti per DaVinci Advanced Panel

Leader della rivoluzione video creativa

Italiano

Indice

Aggiornare DaVinci Advanced Panel con i pulsanti nuovi	76
Rimuovere i pulsanti dal pannello	77
Installare i pulsanti nuovi sul pannello	78
Sostituire i pulsanti e le manopole funzione	78
Disposizione dei pulsanti	80

Aggiornare DaVinci Advanced Panel con i pulsanti nuovi

I nuovi pulsanti per il pannello DaVinci Resolve Advanced Panel consentono di sfruttare appieno tutte le funzioni di DaVinci Resolve 17.

Il kit di installazione include tre involucri in plastica contenenti i pulsanti per ciascun modulo del pannello, e un estrattore per rimuovere i pulsanti originali in modo facile e veloce.

Questa guida spiega come rimuovere e sostituire i pulsanti su DaVinci Resolve Advanced Panel.

DaVinci Resolve Advanced Panel è costituito da tre moduli.



1. T-bar Panel 2. Trackball Panel 3. Search Dial Panel

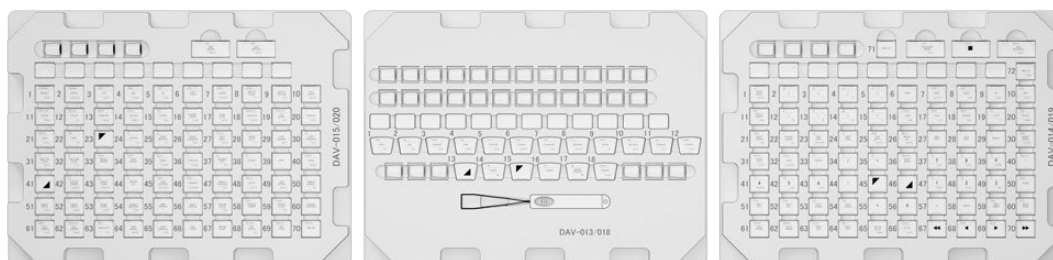

I nuovi pulsanti sono custoditi da tre involucri

NOTA Scollega il pannello dall'alimentazione prima di rimuovere i pulsanti originali. Consigliamo di svolgere l'operazione in un ambiente ben illuminato e di riporre i pulsanti rimossi in un contenitore.

Rimuovere i pulsanti dal pannello

I pulsanti del pannello alloggiano in un piccolo foro di incastro in plastica.

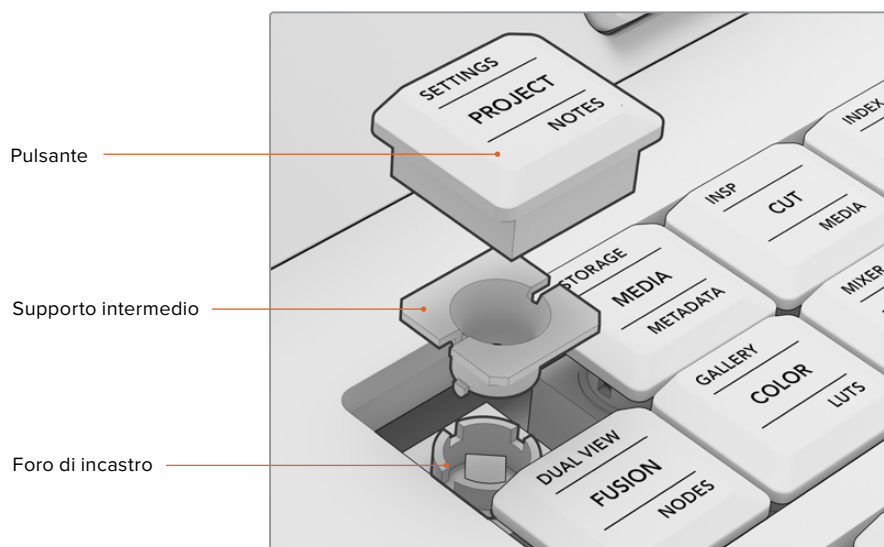

Struttura interna di un pulsante

Come rimuovere un pulsante

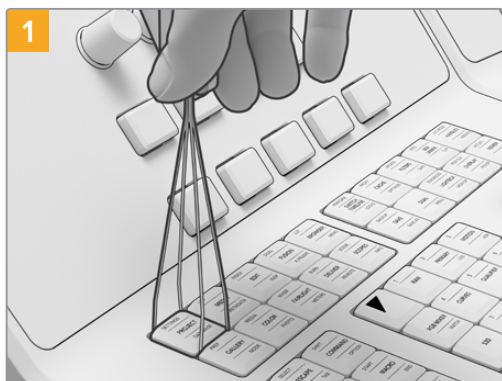

1 Posiziona l'estrattore con le alette sui lati destro e sinistro del pulsante.

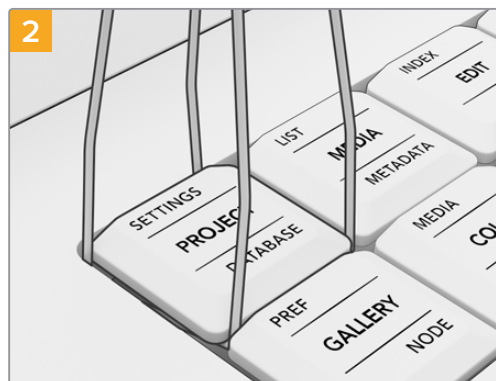

2 Inclina leggermente l'estrattore verso uno dei lati per incastrare l'aletta sotto il pulsante.

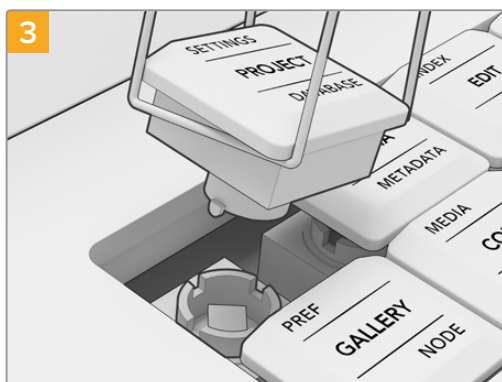

3 Con l'estrattore inclinato rispetto al pannello, tira delicatamente verso l'alto per rimuovere il pulsante dal foro di incastro.

NOTA Se il supporto intermedio bianco del pulsante rimane inserito nel foro di incastro sul pannello, rimuovi i pulsanti circostanti per fare spazio e poi estrai il supporto con le dita.

Dopo aver rimosso tutti i pulsanti originali dal pannello è possibile installare i pulsanti nuovi.

Installare i pulsanti nuovi sul pannello

Consigliamo di installare i pulsanti nuovi su un modulo per volta dai rispettivi involucri in plastica. Fai riferimento alla sezione “Disposizione dei pulsanti” più avanti per disporre i pulsanti correttamente.

Come installare un pulsante

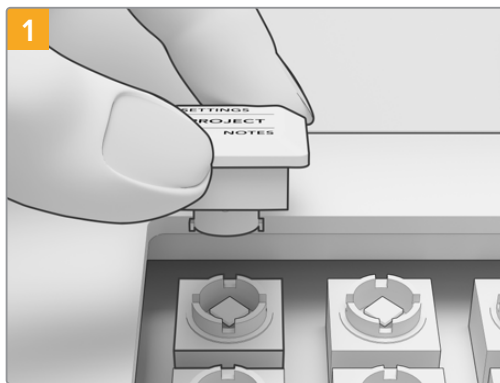

Allinea il supporto intermedio del pulsante con il foro di incastro sul pannello. I punti di fissaggio laterali del supporto devono incastrarsi nelle fessure del foro.

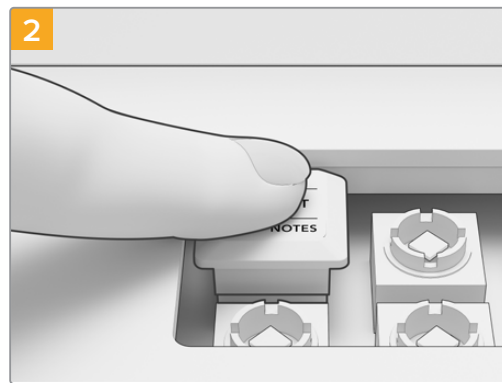

Premi delicatamente il pulsante sul foro fino a sentire un clic.

Dopo aver completato l'installazione dei pulsanti sui tre moduli, collega il pannello all'alimentazione e apri DaVinci Resolve 17 per configurare il pannello aggiornato.

Come configurare il pannello

- 1 Vai su **Preferences > Control Panel**.
- 2 Vai su **Color Grading Panel > DaVinci Resolve Advanced Panel 2**.
- 3 Clicca su **Save**.

Sostituire i pulsanti e le manopole funzione

Il set di nuovi pulsanti per DaVinci Resolve Advanced Panel contiene anche i ricambi per i pulsanti e le manopole funzione. I ricambi sono opzionali e servono per sostituire i controlli originali usurati.

Come sostituire i pulsanti funzione

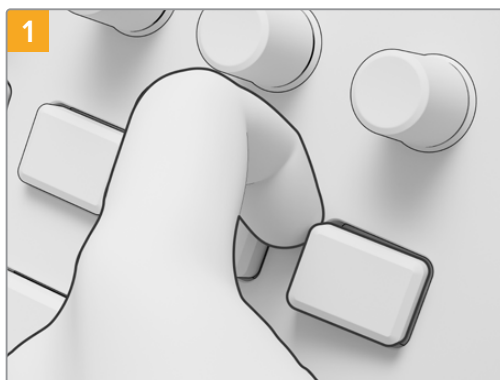

1 Tira delicatamente un angolo del pulsante per rimuoverlo dalla base.

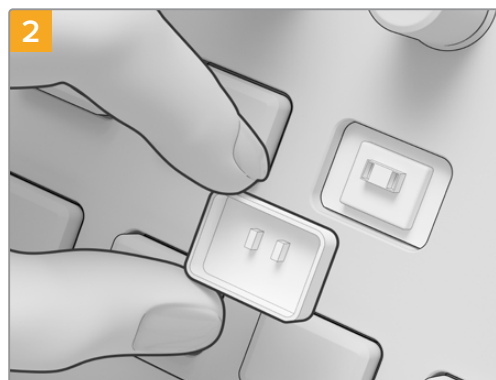

2 Allinea i due piccoli punti di fissaggio in plastica sul retro del pulsante con le fessure della base. I punti di fissaggio devono trovarsi nella parte superiore. Premi delicatamente il pulsante fino a sentire un clic.

Come sostituire le manopole funzione

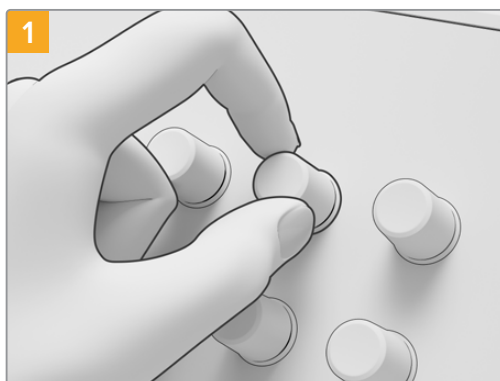

1 Afferra la manopola con l'indice e il pollice ed estraila dal perno.

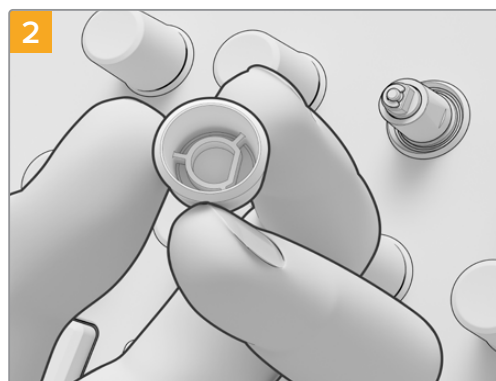

2 Posiziona la manopola di ricambio allineando l'incavo interno a forma di D con il lato superiore del perno.

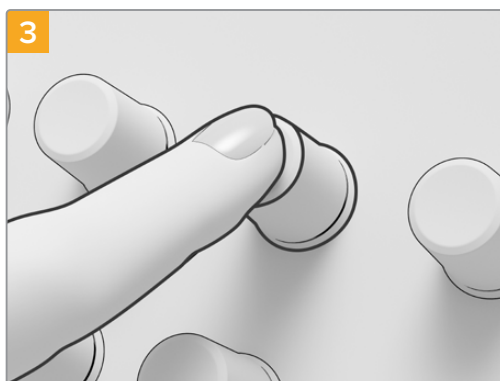

3 Premi la manopola fino alla base del perno.

Disposizione dei pulsanti

Le pagine seguenti illustrano la disposizione corretta dei pulsanti sui tre moduli del pannello. Fai riferimento a queste immagini per installare i pulsanti.

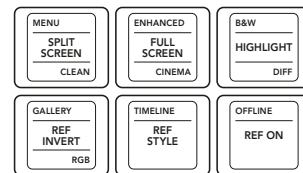
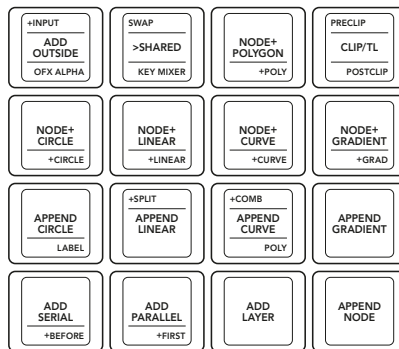
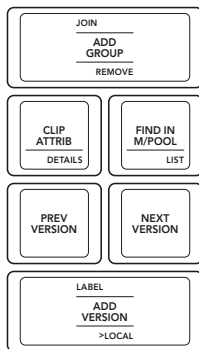
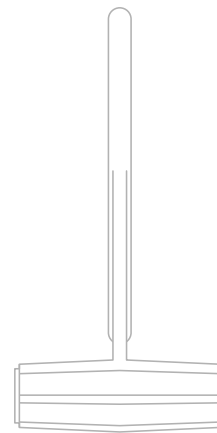
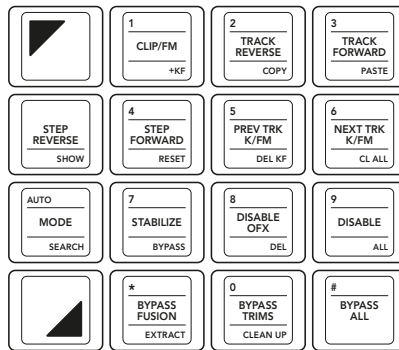
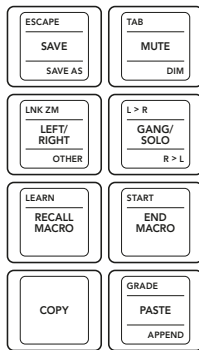
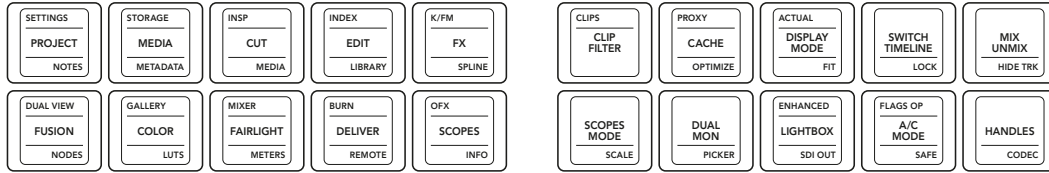

T-Bar Panel

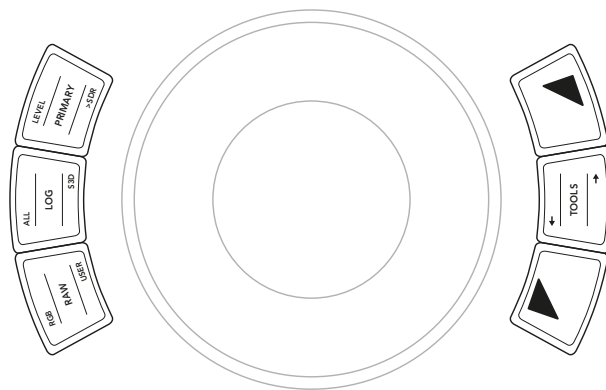
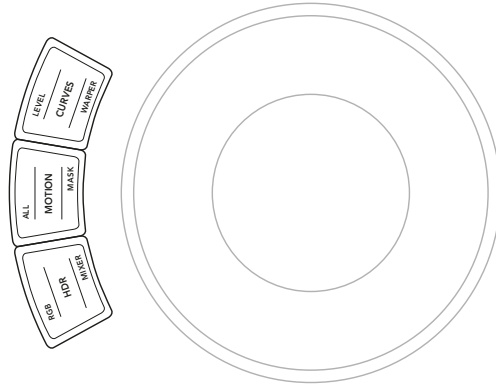
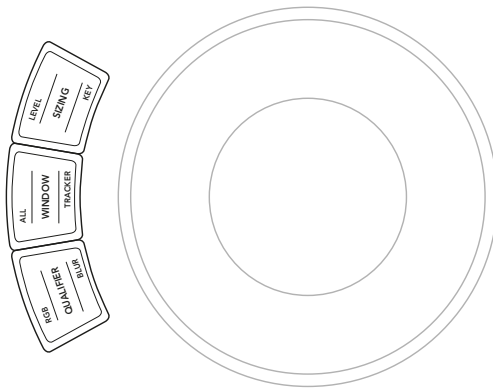
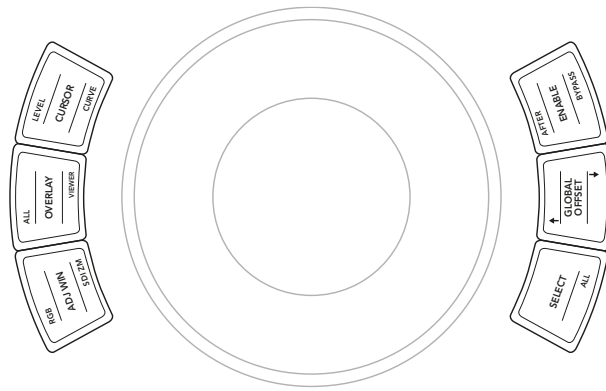

Trackball Panel

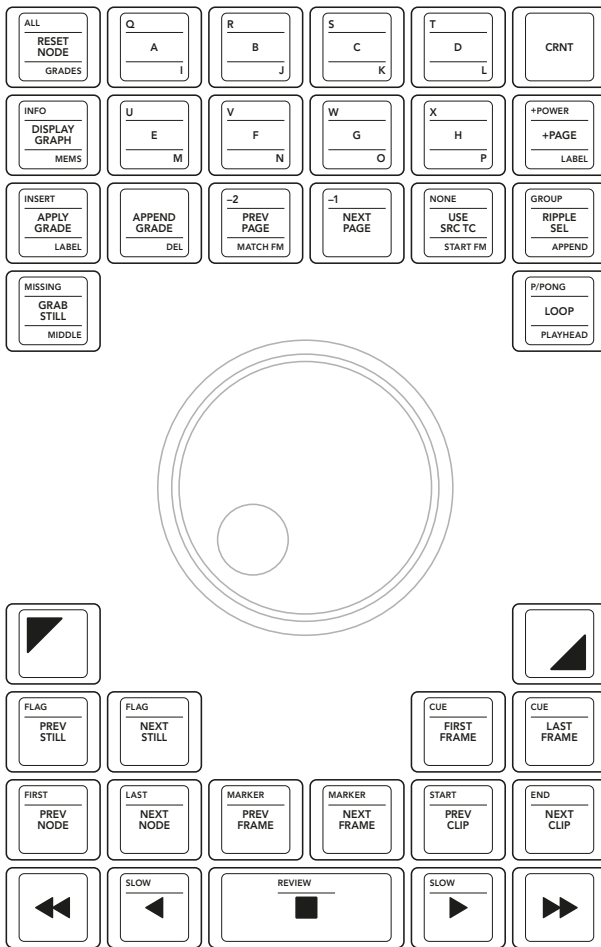

Search Dial Panel

Teclas DaVinci Advanced Panel



Índice

Atualização de Teclas DaVinci Advanced Panel	85
Removendo as Tampas de Botões do Painel	86
Instalando as Novas Tampas no Painel	87
Substituindo Tampas de Teclas e Knobs Multifuncionais	87
Layouts dos Módulos de Tampas	89

Atualização de Teclas DaVinci Advanced Panel

A atualização de teclas DaVinci Advanced Panel moderniza o seu painel avançado para que você possa aproveitar ao máximo todos os recursos do DaVinci Resolve 17.

O kit de atualização das tampas de botões fornece três estojos de plástico contendo todas as tampas de botões necessárias para cada módulo do seu painel avançado. Uma ferramenta de remoção de tampas também foi incluída para facilitar e agilizar a remoção das tampas originais.

Este guia mostra como remover e substituir as tampas dos botões do seu DaVinci Resolve Advanced Panel.

O painel avançado é dividido em três módulos.



1. Painel T-Bar 2. Painel Trackball 3. Painel Search Dial



O kit de atualização de teclas é fornecido em três estojos.

OBSERVAÇÃO Antes de remover as tampas dos botões originais, desconecte o seu painel avançado da fonte de alimentação. É recomendável trabalhar em uma área bem iluminada e utilizar um recipiente para armazenar as tampas dos botões originais.

Removendo as Tampas de Botões do Painel

As tampas dos botões do painel são instaladas em um pequeno suporte de plástico, no qual o botão é pressionado e mantido no lugar.

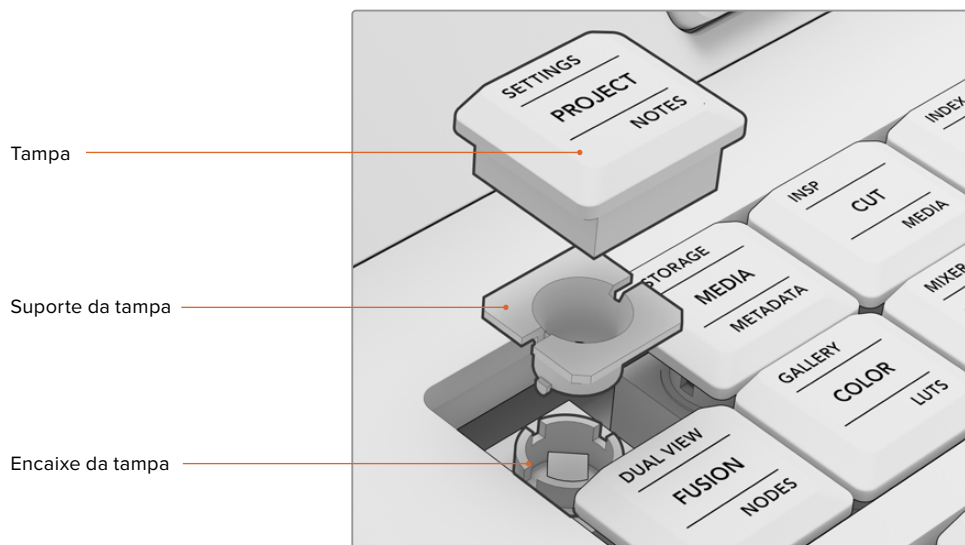

Estrutura da tampa e suporte do botão.

Como remover uma tampa de botão:

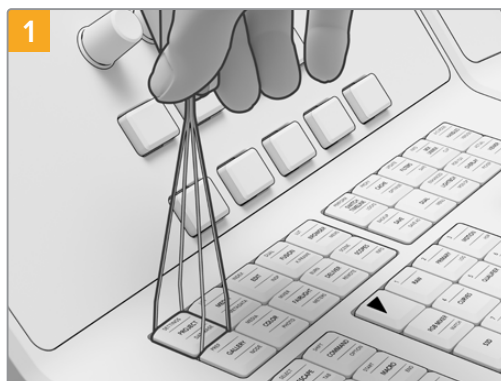

Posicione as pontas da ferramenta de remoção nas laterais da tecla.

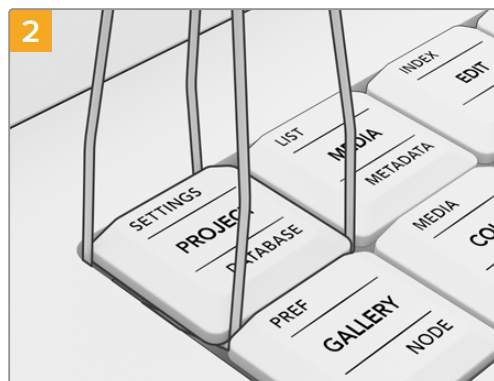

Gire a ferramenta levemente para um dos lados de modo que as pontas fiquem debaixo dos cantos da tampa.

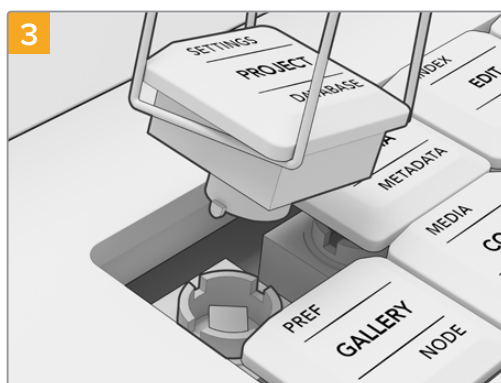

Mantendo a ferramenta posicionada em ângulo reto em relação ao painel, levante cuidadosamente até que a tampa seja removida do encaixe.

OBSERVAÇÃO Ocasionalmente, ao remover uma tampa de botão, você pode observar que o suporte branco se separa da tampa e permanece no interior do painel. Caso isso aconteça, continue a remover as tampas ao redor para abrir espaço. Em seguida, use os dedos para remover o suporte da tampa do interior do painel.

Após remover todas as tampas originais do seu painel avançado, você pode instalar o kit de atualização.

Instalando as Novas Tampas no Painel

Ao instalar as novas tampas, é recomendável trabalhar com um módulo de painel por vez, utilizando o estojo de substituição correspondente. Após instalar cada tampa, consulte a seção 'Layouts dos Módulos de Tampas' neste manual para atribuir cada tampa ao seu encaixe designado.

Como instalar uma tampa de botão:

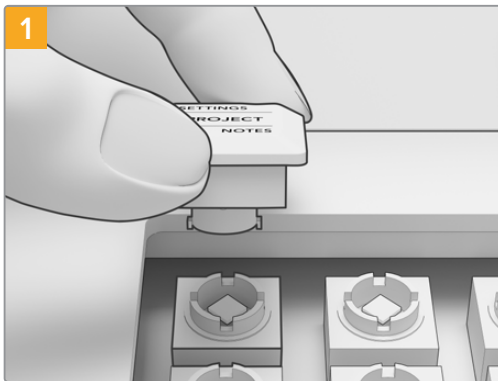

Alinhe o suporte da tampa com o encaixe da tampa dentro do painel. As guias laterais do suporte se encaixam nas ranhuras do encaixe da tampa.

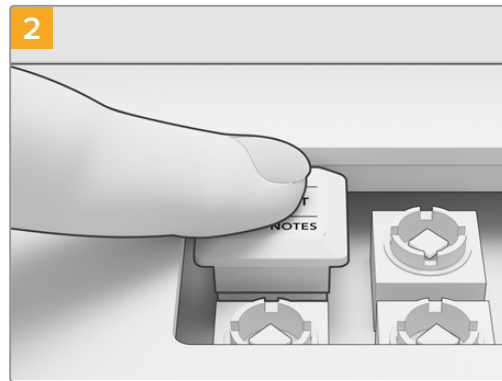

Empurre a tampa em direção ao encaixe cuidadosamente. A tampa deverá se encaixar facilmente e travar na posição correta com um clique.

Quando terminar de substituir as tampas nos três módulos do painel avançado, reconecte a alimentação e inicie o DaVinci Resolve 17. Em seguida, você pode configurar o DaVinci Resolve para o painel atualizado.

Como configurar o painel:

- 1 Vá até Preferências > Painéis de Controle
- 2 No menu "Painel de Gradação de Cor", selecione "DaVinci Resolve Advanced Panel 2".
- 3 Clique em "Salvar".

Substituindo Tampas de Teclas e Knobs Multifuncionais

A atualização de teclas do DaVinci Resolve Advanced Panel também inclui tampas de substituição para teclas e knobs multifuncionais. Essas tampas são substitutas diretas para as tampas originais, portanto a instalação é opcional. Elas podem ser úteis caso suas tampas originais estejam desgastadas.

Substituindo Tampas de Teclas Multifuncionais

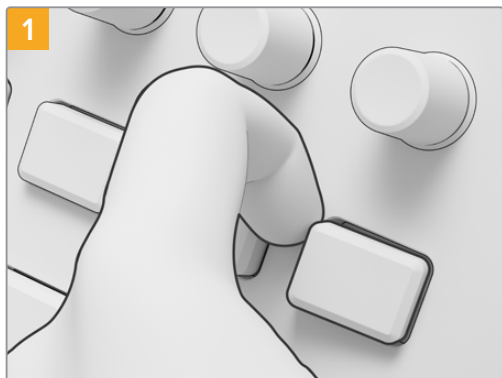

Para remover uma tecla multifuncional, puxe um dos cantos cuidadosamente até que a tampa se solte do encaixe.

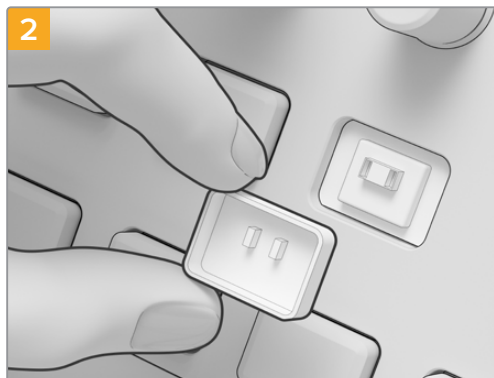

Para instalar uma nova tampa, certifique-se de que as duas guias de plástico no interior da tampa estejam alinhadas com os encaixes do suporte. As guias estão posicionadas um pouco acima do centro da tampa. Pressione a tampa no lugar até sentir um clique.

Substituindo Tampas de Knobs Multifuncionais

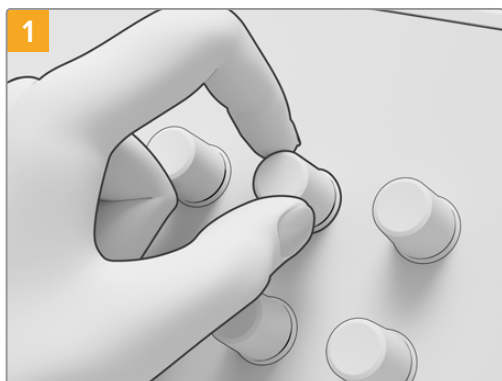

Para remover as tampas dos knobs multifuncionais, segure a tampa firmemente entre o indicador e o polegar e puxe a tampa do eixo giratório.

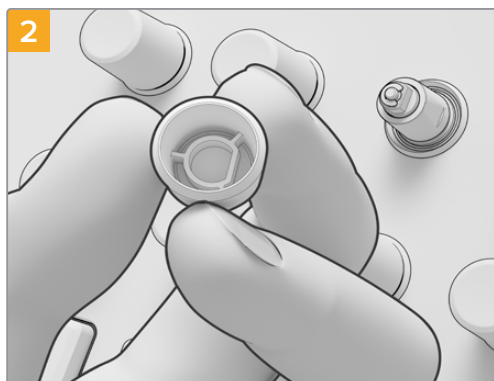

Para instalar uma nova tampa de knob, alinhe o encaixe em formato de "D" com a parte superior do eixo giratório.

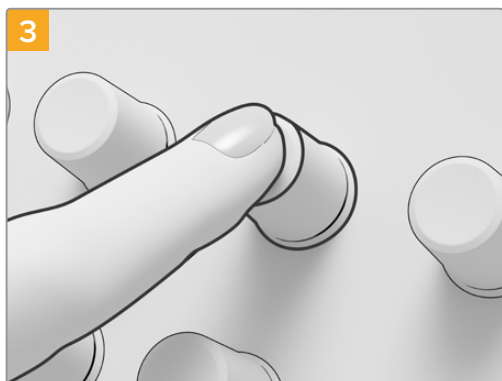

Pressione a tampa sobre o eixo giratório até que ela esteja alinhada com a base.

Layouts dos Módulos de Tampas

Os layouts dos módulos nesta seção mostram a posição de cada botão nos três módulos do painel. Consulte esta seção ao instalar cada tampa no seu painel avançado.

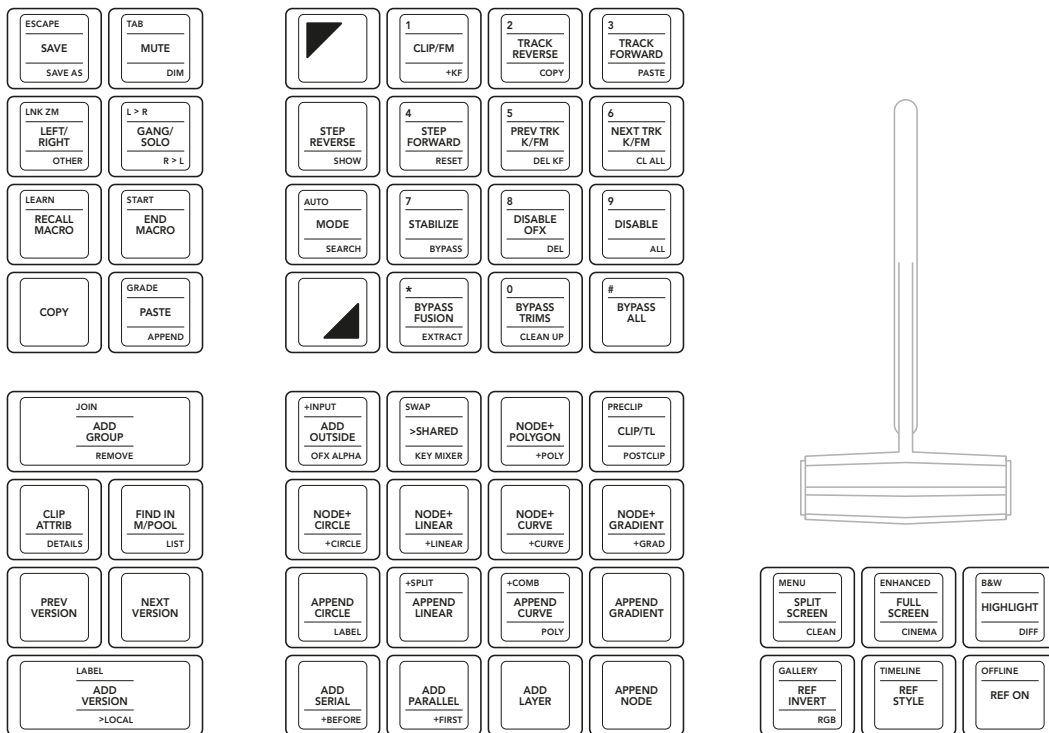
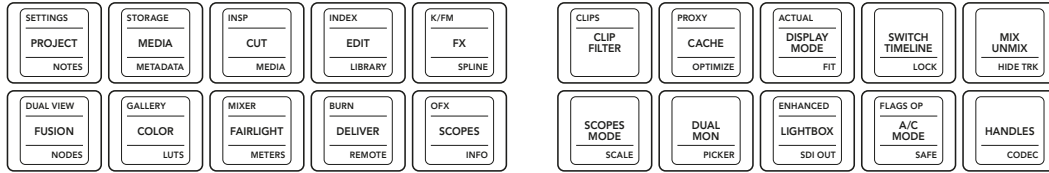

Painel T-Bar

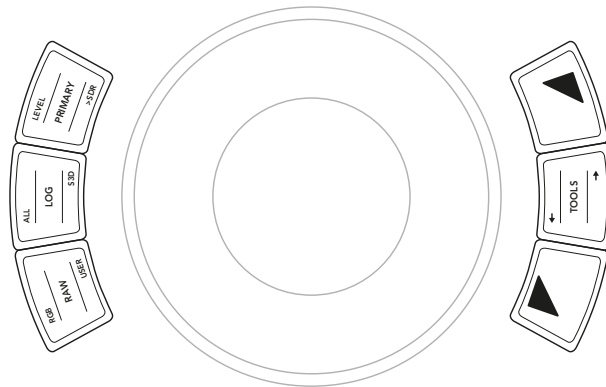
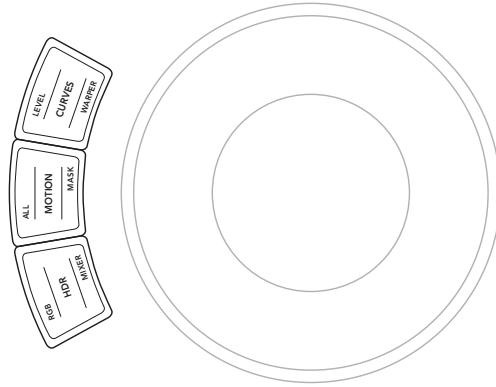
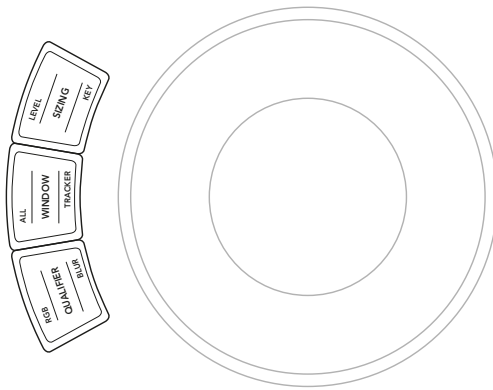
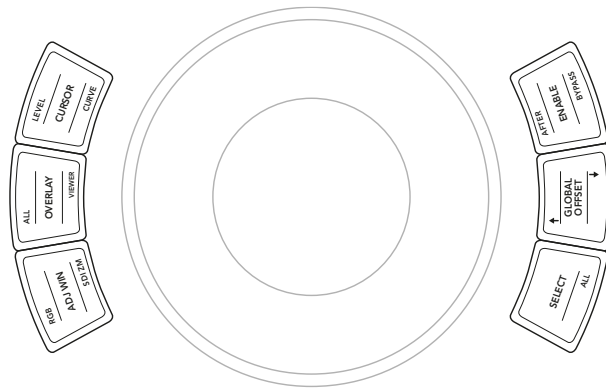

Painel Trackball

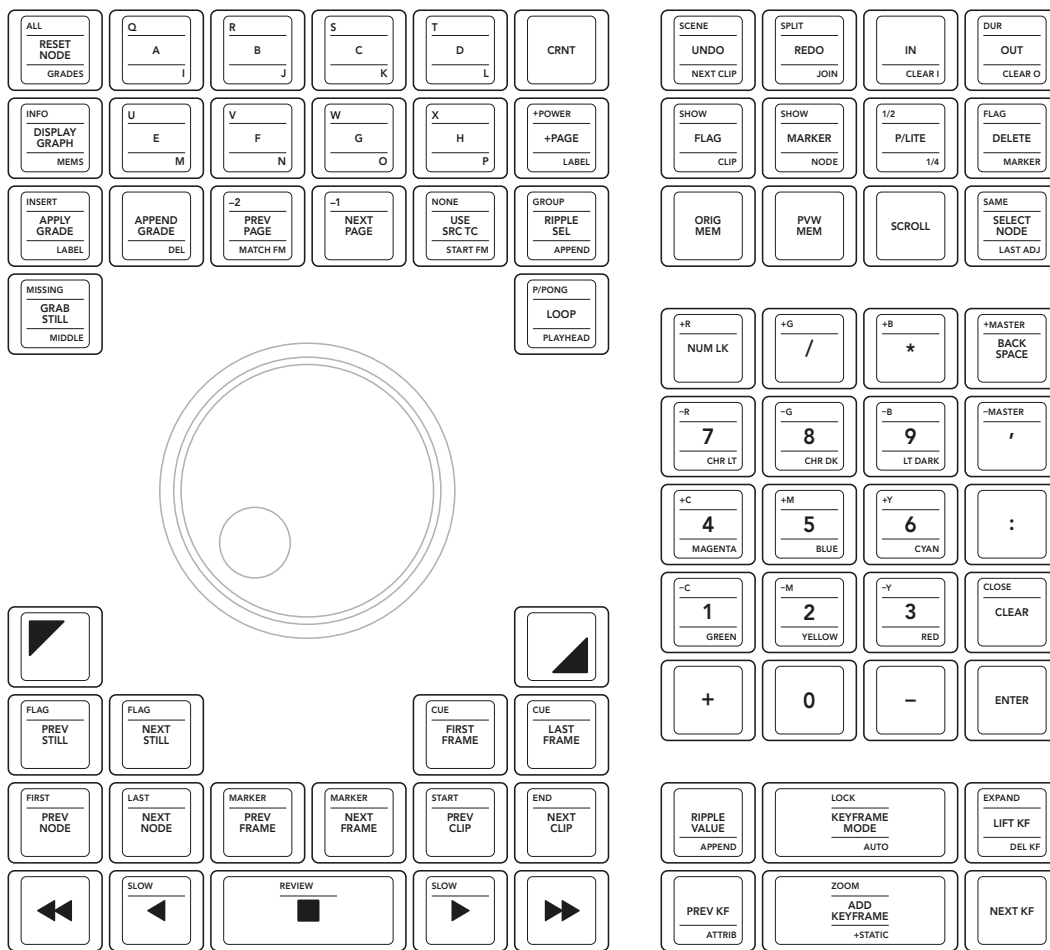

Panel Search Dial

DaVinci Advanced Panel Tuş Kapakları



İçindekiler

DaVinci Advanced Panel Tuş Kapaklarının Yenilenmesi	94
Tuş Kapaklarının Panelinizden Çıkarılması	95
Yeni Tuş Kapaklarının Panelinize Takılışı	96
Yumuşak Tuşların ve Yumuşak Düğmelerin Kapaklarının Değiştirilmesi	96
Tuş Kapağı Modül Düzenleri	98

DaVinci Advanced Panel Tuş Kapaklarının Yenilenmesi

DaVinci Advanced Panel Tuş Kapakları, panelinizin tuş takımını yenileriyle değiştirmenizi sağlar, böylelikle DaVinci Resolve 17'nin tüm özelliklerinden tam olarak yararlanabilirsiniz.

Tuş kapağı yenileme takımı, Advanced panelinizin her bir modülü için gerekli olan tüm yedek tuş başlıklarını içeren üç plastik paketten oluşur. Orijinal tuş kapaklarının hızlı ve kolay bir şekilde çıkarılması için bir tuş kapağı çıkarma aleti de dahil edilmiştir.

Bu kılavuz, DaVinci Resolve Advanced Panel'inizdeki tuş kapaklarını nasıl çıkaracağınızı ve değiştireceğinizi gösterir.

Advanced panel, üç modüle ayrılmıştır.



1. T-kolu Paneli 2. İztopu paneli 3. Arama Kadranı Paneli

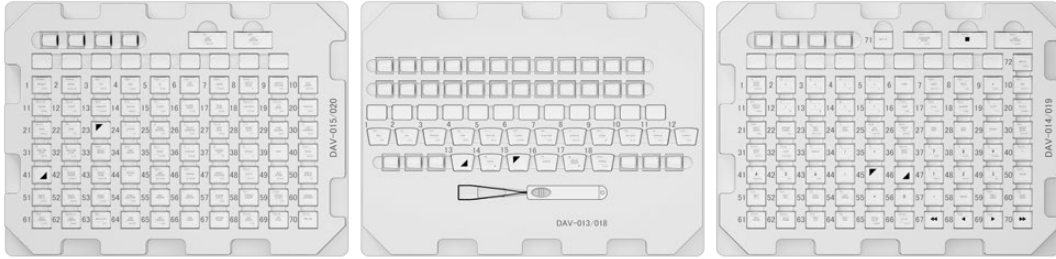

Tuş kapağı yenileme takımı, üç plastik paketten oluşur

NOT Orijinal tuş kapaklarını çıkarmaya başlamadan önce, panelinizin güç kablosunu çıkarın. Değiştirme işlemini iyi aydınlatılmış bir ortamda yapmanız ve ayrıca orijinal tuş kapaklarını saklamak için bir kutu bulundurmanız da tavsiye edilir.

Tuş Kapaklarının Panelinizden Çıkarılması

Panelinizdeki tuş kapakları, tuşun içine bastırıldığı ve tuşu yerinde tutan küçük bir plastik yuvaya oturtulmuştur.

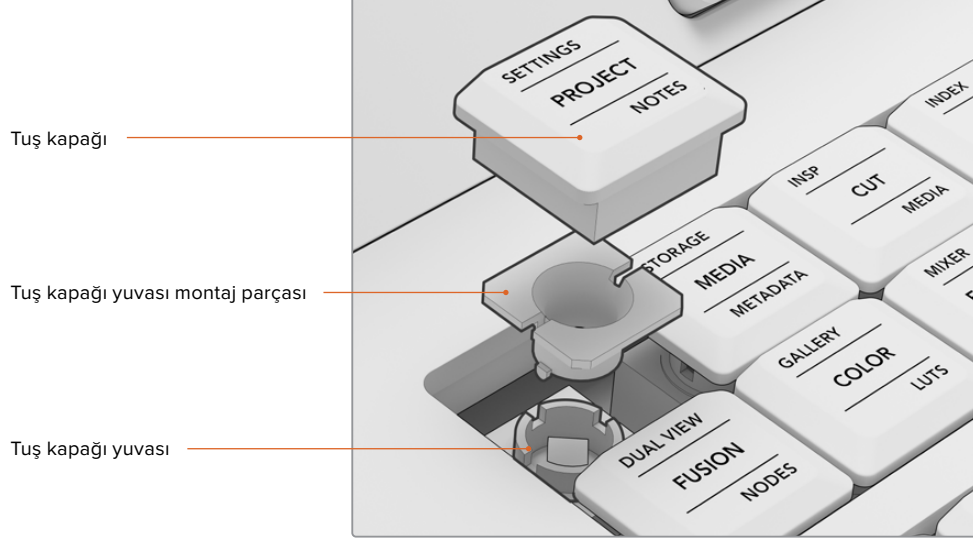

Tuş kapağı ve tuş kapağı yuvasının yapısı

Bir tuş kapağını çıkarmak için

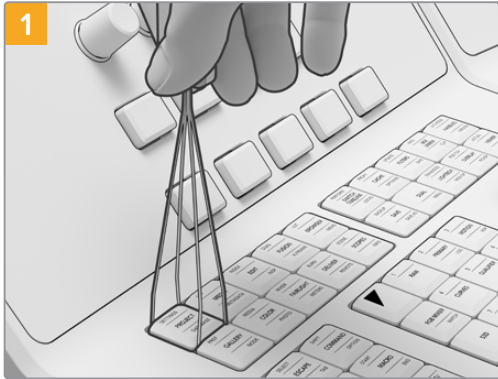

Tuş kapağı çıkarma aletinin uçlarını tuş kapağının her iki yanına yerleştirin.

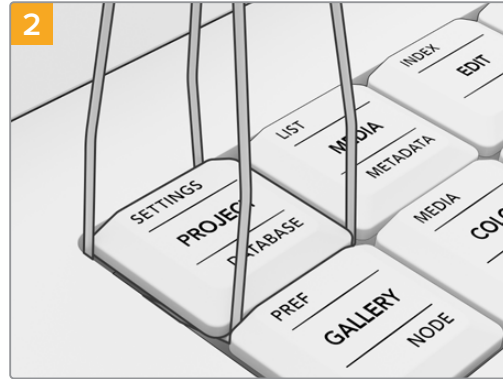

Çıkarma aletini hafifçe yana çevirin, böylece uçlar tuş kapağının köşe altlarına oturur.

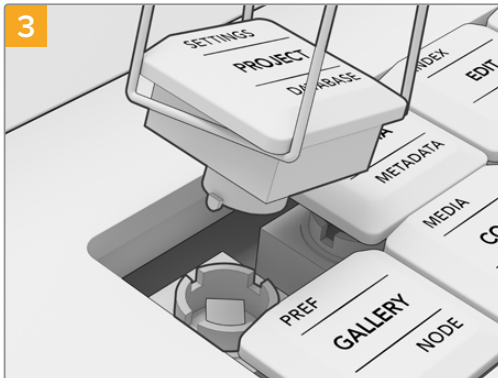

Çıkarma aletini panele dik bir açı yapacak şekilde tutarak, yuvasından çıkana kadar tuş kapağını hafifçe yukarı kaldırın.

NOT Bir tuş başlığını çıkarırken, bazen kapağın beyaz renkli yuva montaj parçasının kapaktan çıktığını ve panelin içinde kaldığını görebilirsiniz. Bu durumda, alan açmak için etrafındaki tuş kapaklarını çıkarın ve sonra tuş kapağı yuva montaj parçasını panelden çıkarmak için parmaklarınızı kullanın.

Orijinal tuş kapaklarının tamamı panelinizden söküldükten sonra yeni tuş kapağı takımını takabilirsiniz.

Yeni Tuş Kapaklarının Panelinize Takılışı

Yeni tuş kapaklarını takarken, sadece bir panel modülü ve o modüle ait yeni tuş kapağı paketi ile çalışmanız tavsiye edilir. Her bir tuş kapağını takarken, tuş başlığını belirtilen yuvasına takmak için bu kılavuzun ileri sayfalarındaki "tuş kapağı modül düzenleri" bölümüne bakın.

Bir tuş kapağını takmak için

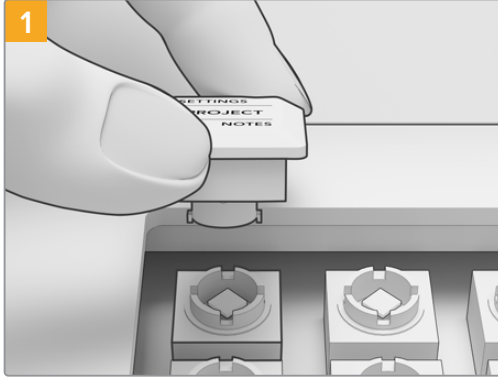

Tuş kapağı montaj parçasını, panelin içindeki tuş kapağı yuvasına hizalayın. Tuş kapağı montaj parçasındaki yan tırnaklar, tuş başlığı yuvasındaki oyuklara oturacaktır.

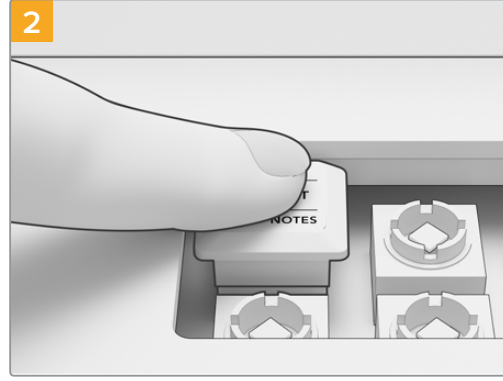

Tuş kapağını yavaşça yuvaya bastırın. Tuş kapağının kolayca ve tıklayarak yerine oturması gerekir.

Advanced panelinizin üç bölümündeki tuş kapaklarının tamamını değiştirdiğinizde, güç kablosunu yeniden takın ve DaVinci Resolve 17'yi başlatın. Ardından, güncellenen panel için DaVinci Resolve'yi yapılandırabilirsiniz.

Paneli yapılandırmak için:

- 1 Preferences > control panel sekmesine gidin
- 2 'Color Grading Panel' menüsünden, 'DaVinci Resolve Advanced Panel 2'yi seçin
- 3 'Save' ibaresini tıklayarak kaydedin.

Yumuşak Tuşların ve Yumuşak Düğmelerin Kapaklarının Değiştirilmesi

DaVinci Advanced Panel Tuş Kapakları aynı zamanda, yedek yumuşak tuş ve yumuşak düğme kapakları ile birlikte gelir. Bunlar, orijinal kapaklarla aynı olduklarından takılmaları isteğe bağlıdır. Orijinal yumuşak kapaklarınız aşındığında kullanabilirsiniz.

Yumuşak Tuş Kapaklarının Değişirilmesi

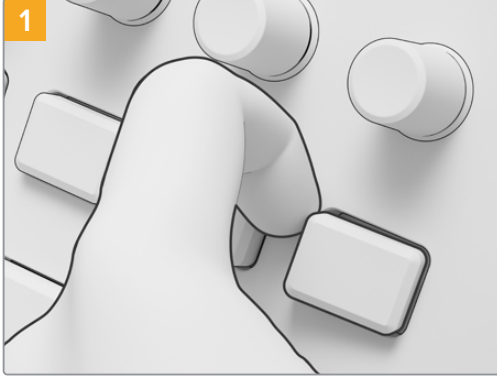

1 Bir yumuşak tuşu çıkarmak için, yuvasından çıkana kadar kapağı bir köşesinden yavaşça çekin.

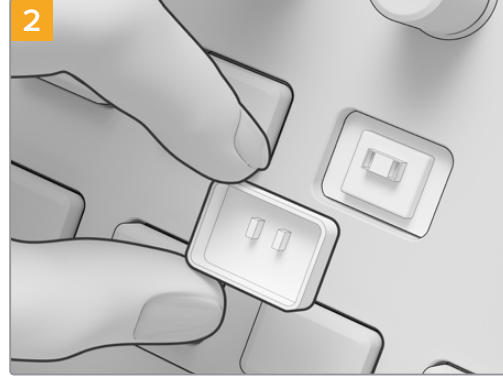

2 Yeni bir yumuşak tuş kapağını takmak için, kapağın altındaki iki küçük plastik tırnağın, yuva üzerindeki deliklerle hizalandığından emin olun. Tırnaklar, merkezin hafifçe üzerinde yer alır. Tıkladığını hissedene kadar kapağı yerine bastırın.

Yumuşak Düğme Kapaklarının Değişirilmesi

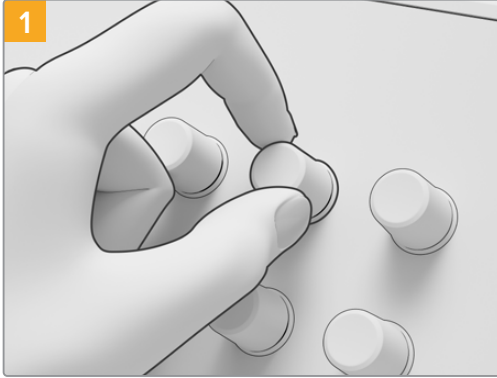

1 Yumuşak düğme kapaklarını çıkarmak için, işaret parmağınız ve başparmağınız arasında kapağı sıkıca tutun ve düğmeyi aks yuvasından çekin.

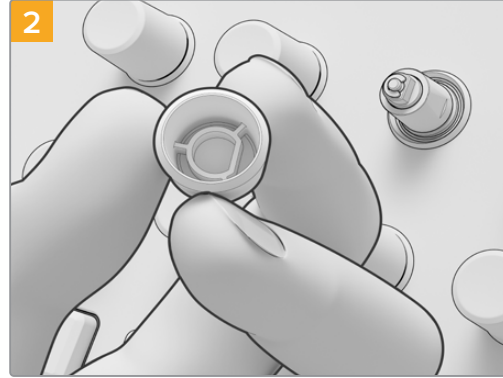

2 Yeni bir yumuşak düğme kapağını takmak için, D şeklindeki kapak yuvasını, düğme milinin üst kısmıyla hizalayın.

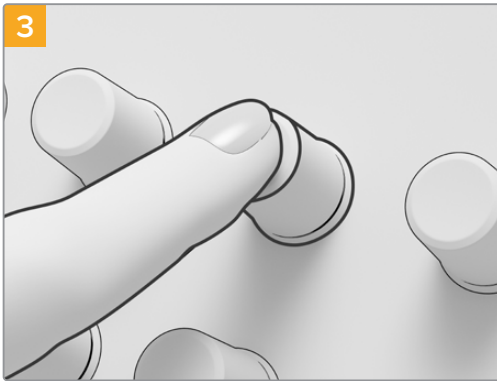

3 Milin tabanı ile aynı hizaya gelene kadar kapağı milin üstüne bastırın.

Tuş Kapağı Modül Düzenleri

Üç panel modülündeki her düğmenin konumunu, bu bölümdeki modül düzenleri gösterir. Tuş kapaklarından her birini panelinize takarken, bu bölüme başvurun.

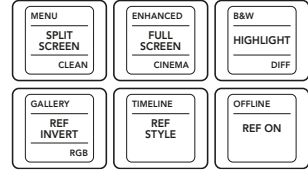
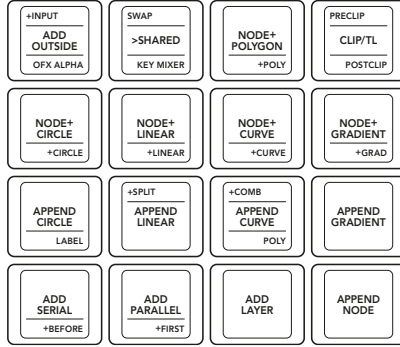
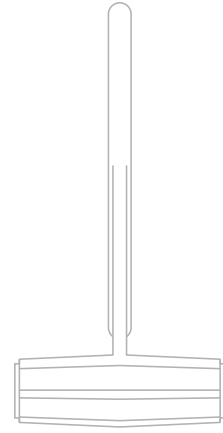
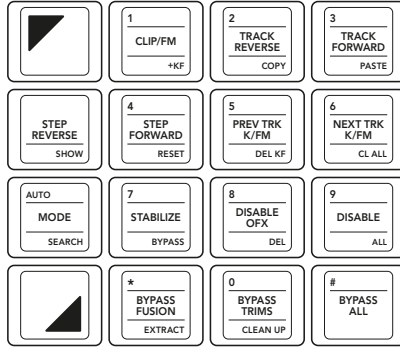
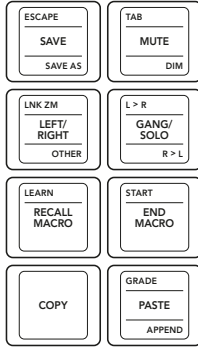
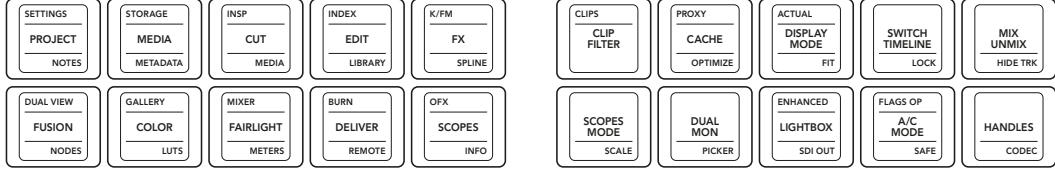

T-kolu Paneli

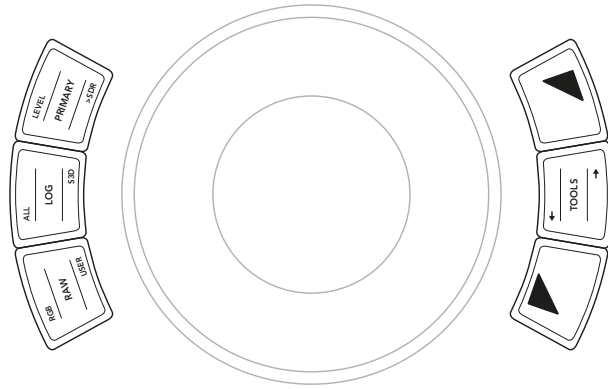
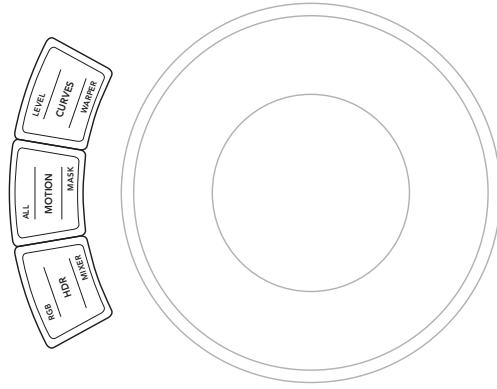
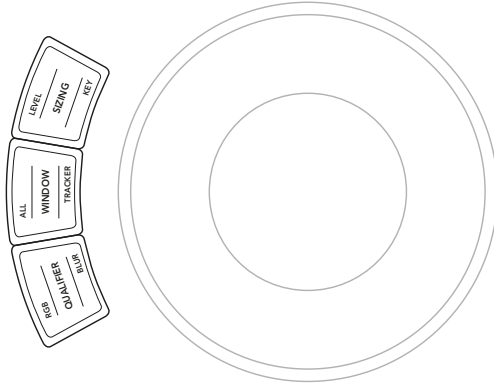
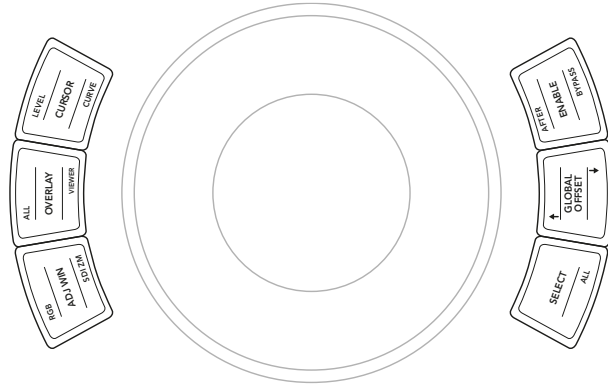

İztopu Paneli

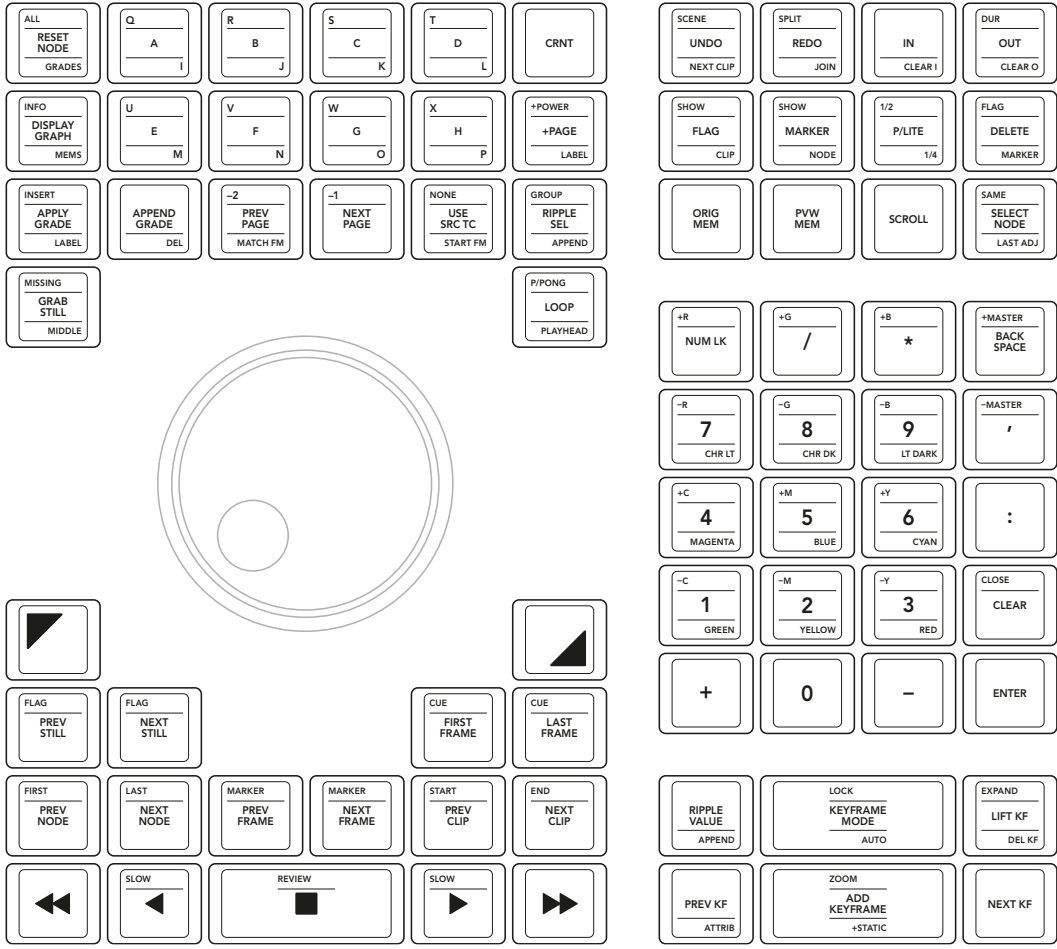

Arama Kadranı Paneli