

Blackmagicdesign



Installation and Operation Manual

Blackmagic Duplicator 4K

February 2019

English, 日本語, Français, Deutsch, Español, 中文,
한국어, Русский, Italiano, Português and Türkçe.

Languages

To go directly to your preferred language, simply click on the hyperlinks listed in the contents below.

English	3
日本語	39
Français	76
Deutsch	113
Español	150
中文	188
한국어	225
Русский	262
Italiano	299
Português	336
Türkçe	373



Welcome

Thank you for purchasing your Blackmagic Duplicator 4K.

We are extremely excited with Blackmagic Duplicator 4K and think it is the perfect solution to make it possible for you to distribute high quality Ultra HD content direct to your customers. This is possible because the duplicator will record onto 25 separate SD cards in all SD, HD and Ultra HD formats up to 2160p60 in widely used H.264 or latest H.265 compression so you get amazing quality and high frame rates but with low enough data rates that you can use cheap cards and get a long record duration.

Blackmagic Duplicator 4K is easy to set up and use. The front panel has a built in LCD and control panel so you can change settings and control the unit using buttons, but you can also control your duplicator remotely via Ethernet or by connecting an RS-422 controller. You can even custom build your own controller and control the unit using the Blackmagic HyperDeck Ethernet Protocol.

The built in real time H.265 video encoder records high quality video on inexpensive SD cards in video formats up to Ultra HD 2160p60, so you can record amazing Ultra HD video without having to use the fastest cards available. With the latest Blackmagic Duplicator 4K version 1.2 software, we've added H.264 compression so you can also record H.264 files for greater compatibility!

Blackmagic Duplicator 4K is 1 rack unit high which means you can daisy chain a bank of units in a portable rack system and take them with you on location so you can always record on hundreds of SD cards at once.

This instruction manual contains all the information you need to start using your Blackmagic Duplicator 4K.

Please check the support page on our website at www.blackmagicdesign.com for the latest version of this manual and for updates to your Blackmagic Duplicator 4K's software. Keeping your software up to date will ensure you get all the latest features! When downloading software, please register with your information so we can keep you updated when new software is released. We are continually working on new features and improvements, so we would love to hear from you!

A handwritten signature in black ink that reads "Grant Petty". The signature is written in a cursive, flowing style.

Grant Petty
CEO Blackmagic Design

Contents

Blackmagic Duplicator 4K

Getting Started	5
Plugging in Power	5
Plugging in Video and Audio	5
Daisy Chaining	6
Inserting and Formatting SD Cards	7
Recording	8
Setting the Recording Mode	8
Setting the Codec	9
Setting the Bit Rate	10
Recording Clips	11
LED Status Indicators	11
Append Record	12
Locking your Blackmagic Duplicator 4K	13
Daisy Chaining Multiple Duplicators	13
LCD Menu Settings	15
Record	15
Settings	20
About	21
Blackmagic Duplicator Utility	21
Updating your Blackmagic Duplicator 4K	21
File Name Prefix	21
Installing the optional Optical Fiber SDI Module	22
RS-422 Control	23
What is RS-422 Control?	23
Using an External RS-422 Controller	23
RS-422 Developer Information	25
Remote Control via Ethernet	25
An Example of Controlling via an Arduino	26
Blackmagic HyperDeck Ethernet Protocol	28
Protocol Commands	28
Protocol Details	29
Configuring the watchdog	34
Configuring the record mode	34
Configuring the file format	34
Help	35
Regulatory Notices	36
Safety Information	37
Warranty	38

Getting Started

Getting started with your Blackmagic Duplicator 4K is easy!

All you need to do is plug in power, connect your SDI video source and insert up to 25 SD cards. If you want to record on even more SD cards, you can daisy chain multiple Blackmagic Duplicator 4Ks and that's easy to do because there are built in video and control connections to connect to each downstream unit. This section of the manual will show you exactly how to set up your Blackmagic Duplicator 4K so you can immediately begin recording on multiple SD cards simultaneously.

Plugging in Power

To power your Blackmagic Duplicator 4K, simply plug a standard IEC power cord into the 110-240V AC power input on the rear panel.

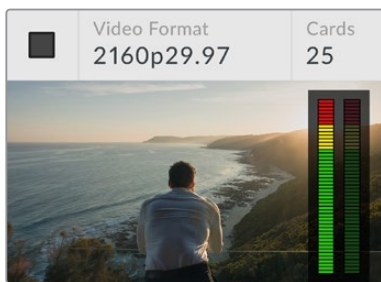

When Blackmagic Duplicator 4K is powered you will see the home screen appear on the built in LCD.

Home Screen

The home screen displays the source video image and information such as the source video format, the number of SD cards inserted, a status indicator to show you when you are recording and when recording is stopped, plus audio meters so you can monitor the audio levels in your source video.

Plugging in Video and Audio

Plug your source video into 12G-SDI input on the rear panel. Your Blackmagic Duplicator 4K will automatically detect the input format and display it on the LCD home screen.

The SDI input and output BNC connectors support video signals up to 12G-SDI so you can plug in SD, HD or Ultra HD video up to 2160p60 on a single BNC cable. This means the loop output will always match your source video format so you can output the same signal to other SDI video equipment, or for when daisy chaining multiple Blackmagic Duplicator 4Ks together. It also supports progressive segmented frame modes, and automatically detects level A and level B 3G-SDI formats for 1080p50, 1080p59.94 and 1080p60.

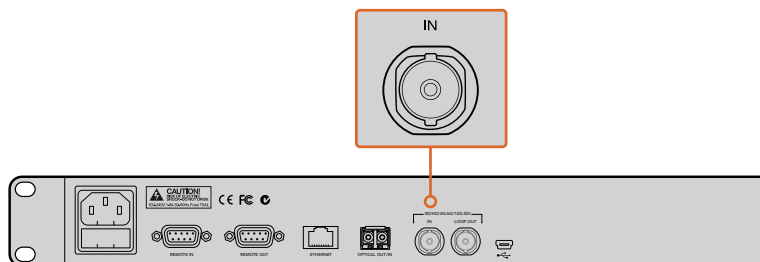

Plug your source video into the SDI in connector. Audio is embedded in the SDI video signal.

Your Blackmagic Duplicator 4K supports 2 channels of embedded SDI audio, so you don't need to plug in audio as it is already connected via the SDI video input.

TIP You can monitor your source video's audio levels on the LCD home screen.

Daisy Chaining

You can daisy chain multiple Blackmagic Duplicator 4Ks so you can record on even more SD cards. For example, if you wanted to duplicate 100 cards, then you just daisy chain 4 units together.

- 1 Connect the RS-422 'remote' output from the first Blackmagic Duplicator 4K to the 'remote' input on the second unit. Repeat this process for each unit in the chain.
- 2 Similarly, connect the loop SDI output from the first unit to the SDI input of the second unit and repeat for each unit down the chain
- 3 On each unit's control panel there is a button marked REM. This is the 'remote' button and it needs to be turned on to enable remote control between units. Press the remote buttons on each Blackmagic Duplicator 4K from the second unit all the way down the chain.

NOTE Make sure the first unit has the remote button turned off as this will be the Blackmagic Duplicator 4K that controls all the others in the chain. This first unit, with the remote turned off, is the master unit and any button pressed on its front panel will be output from the remote output and this is what controls the downstream units with their remote buttons turned on. Any television product with RS-422 deck control can be the master unit as the remote protocol is simply the industry standard deck control format.

Now all Blackmagic Duplicator 4Ks in the chain are ready to follow the commands of the first unit.

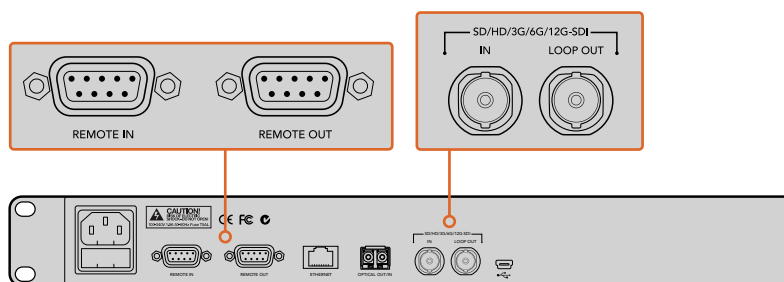

The 'remote' and 'loop' connectors are used for daisy chaining multiple Blackmagic Duplicator 4Ks. The loop connector on the last unit in the chain can also be used to loop the source video to other SDI equipment such as a Blackmagic SmartView monitor or HyperDeck disk recorder.

For more detailed information about daisy chaining multiple units, refer to the section titled, 'Daisy Chaining Multiple Duplicators'.

Inserting and Formatting SD Cards

Blackmagic Duplicator 4K uses common class 10 SD cards so you don't have to buy the fastest cards available. SD cards can be purchased from any store that sells camera equipment, and even some supermarkets sell class 10 SD cards.

TIP On the label of all SD cards you will see a number from 1 to 10 printed in a small circle. This number represents the speed rating of the card and 10 is the fastest rating. Any card that has the number 10 printed in the circle is a class 10 SD card and the type of card you will need to record up to Ultra HD video at the highest bit rate setting.

To insert an SD card:

- 1 Hold the card with the gold connectors facing the control panel LCD and align it with one of your Blackmagic Duplicator 4K's SD card slots.
- 2 Gently push the card into the slot until it is firmly seated. Your Blackmagic Duplicator 4K verifies the card quickly, and when the card is ready to record status LED above the slot turns green.

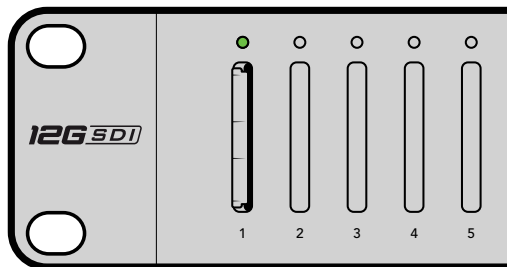
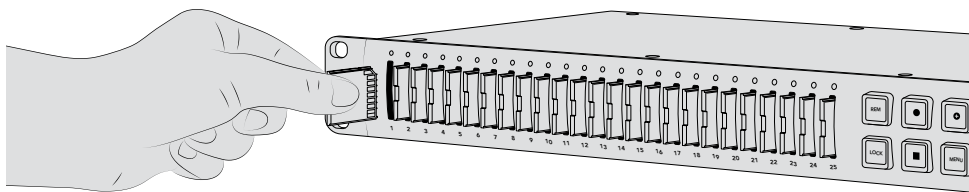

Align the SD card with the gold connectors facing the LCD and gently push the card into the slot until it is firmly seated. The LED status indicator turns green when your card is ready to record.

To remove a card, simply hold the card by its edge and remove it from the slot.

TIP When inserting a card, make sure the card is not write protected. Write protection is disabled by moving the little plastic switch on the left side of the card to the position closest to the connectors. After recording, you can then write protect the card by sliding the switch back down to the bottom position.

Formatting SD Cards

Before you can start recording, you will need to format your SD cards to exFAT format. This format is compatible on both macOS and Windows computers. It's easy to format your media using your Blackmagic Duplicator 4K's 'format' feature and can be used to format up to 25 SD cards simultaneously on a single unit.

To format your SD cards on Blackmagic Duplicator 4K:

- 1 Press the 'Menu' button on the control panel.
- 2 Using the illuminated soft menu buttons on each side of the LCD, press 'record'.
- 3 Press the left arrow soft button to select the 'format cards' setting, then press 'format' at the bottom right side of the LCD menu.
- 4 A warning message will appear asking you to confirm the format. Press the 'format' soft button to confirm the format, or press 'cancel' to stop.
- 5 A progress bar will show you the progress of the format. When the format is complete, press 'OK'.
- 6 Press the 'menu' button on the control panel to return to the home screen.

That's all there is to getting started. With your video and audio connected and your SD cards formatted, you can now start recording!

TIP Different types and sizes of SD cards may format at different speeds so some cards will complete formatting faster than others.

Recording

You can start recording immediately by pressing the record button on the control panel. But we recommend setting the recording mode, codec, and bit rate first as these set the type of recording used, plus the length and quality of your recording.

Setting the Recording Mode

Blackmagic Duplicator 4K has the following recording modes:

- **Duplicate:** write to all SD cards simultaneously.
- **Single Disk:** write to one SD card at a time in order and stop recording when the last card is full.
- **Single Disk Overwrite:** write to one SD card at a time in order, and overwrite in a continuous loop.

Duplicate Mode

In duplicate mode, Blackmagic Duplicator 4K records the same video onto all SD cards at the same time.

Single Disk Mode

Blackmagic Duplicator 4K is an ideal logging recorder with a multitude of applications from television broadcasts to security cameras. It writes to one SD slot at a time, and when that SD card is full then it continues on the next available slot. When Blackmagic Duplicator 4K is in single disk mode, it stops recording when all SD cards are full. With 25 recording slots available, you can easily record for as long as a week. For continuous and uninterrupted recording, you can swap out full cards for empty cards at any time.

If you have multiple duplicators daisy chained together, you can record even longer. As soon as all cards are full in the master unit, recording will continue on the first slave unit through the chain to all connected units. Recording stops when the last card on the last unit is full.

Single Disk Overwrite Mode

Single disk overwrite mode allows a single Blackmagic Duplicator 4K with two or more SD cards to loop back to the first card when the last card is full so it records continually. It writes to one SD slot at a time. When one SD card is full then it formats and writes to the card in the next available slot.

This mode is similar to single disk mode, except the unit formats and writes to the next card in a loop, rather than stopping after the last card is full. In single disk overwrite mode, your Blackmagic Duplicator 4K will keep recording indefinitely until you press stop.

TIP If you are recording in single disk mode or single disk overwrite mode, you can insert new SD cards with space at any time. Duplicator 4K will continue recording as long as there are cards in any of the 25 slots with free space to record onto.

To set a recording mode:

- 1 Power Blackmagic Duplicator 4K.
- 2 Press the 'menu' button on the front control panel to open the LCD menu. The soft buttons next to the screen are lit to refer to options on the menu. Press the 'record' soft button.

The record menu has dots at the bottom of the screen to indicate how many options are available. If you want to move up to the previous level of the menu hierarchy at any time, press the 'back' button. Use the < and > buttons to cycle through the options.
- 3 Navigate to the 'mode' option, and click 'change'.
- 4 Press the 'select' button to use the mode currently shown. The LCD menu indicates the option you have selected.
- 5 Press the 'back' button to return to the record menu. The option you selected is now displayed.

For more information on daisy chaining multiple duplicators together, refer to the sections titled, 'daisy chaining' and 'daisy chaining multiple duplicators'.

TIP If an important event is recording in single disk or single disk overwrite mode, and you want to remove the SD card without waiting for the current card to fill up, simply press and hold the 'record' button for three seconds to switch to recording on the next SD card. When recording in duplicate mode, you can press the 'append record' button. For more information, see the 'Append record' section.

Setting the Codec

Your Blackmagic Duplicator 4K can record files using H.264 or H.265 compression codecs. H.264 compression is the default codec.

To change the codec:

- 1 Press the 'menu' button
- 2 Press the 'record' soft button to open the record settings.
- 3 Navigate to the 'codec' setting using the arrow soft buttons and press 'change.'
- 4 Use the arrow soft buttons to select your preferred codec, then press 'set' to confirm the change, or press the 'menu' button on the control panel to confirm the change and return to the LCD home screen.

NOTE Your Blackmagic Duplicator 4K must be updated to software version 1.1 or above to change codecs. For more information on updating software see the 'Blackmagic Duplicator Utility' section in this manual.

Choosing the right codec

For the best compatibility, we recommend using the H.264 codec. That is why we have made H.264 the default codec for Blackmagic Duplicator 4K.

H.265 is a great codec for high quality Ultra HD video at smaller file sizes, but is still very new and so there may be less compatibility with computers and playback equipment.

Both codecs have their advantages. Using H.265 will let you use cheaper SD storage, as the bit rates and sizes of files will be lower for a given image quality. H.264 is a good choice if compatibility is vital to your project.

Setting the Bit Rate

The three bit rate settings on your Blackmagic Duplicator 4K are low, medium, and high. These let you choose how much data is written by the built in video encoder for each second of video. The default bit rate setting is 'medium' for a high quality recording and a manageable file size. However you can easily change that setting in the LCD menu.

To change the bit rate setting:

- 1 Press the 'menu' button.
- 2 Press the 'record' soft button to open the record settings.
- 3 Navigate to the 'bit rate' setting using the arrow soft buttons and press 'change.'
- 4 Use the arrow soft buttons to select your preferred bit rate, then press 'set' to confirm the change, or press the 'menu' button on the control panel to confirm the change and return to the LCD home screen.

NOTE Higher bit rates result in higher quality recordings, but will fill a card faster or require a bigger and more expensive card. However, reducing the data rate will increase the time you can record on a card, but could reduce image quality to lower than you desire.

It's worth recording some experiments using different bit rate settings to get just the right amount of picture quality you need in the smallest file size.

Recording Clips

To start recording, simply press the record button on the control panel. When recording, the LED status indicators for each slot will illuminate red. When recording is stopped, the LED indicator will illuminate green, letting you know the recording was successful and the card is ready to record another clip. You can easily check your recordings on a computer via its SD card slot or reader, or on an HDMI television if it supports SD cards and the exFAT file system.

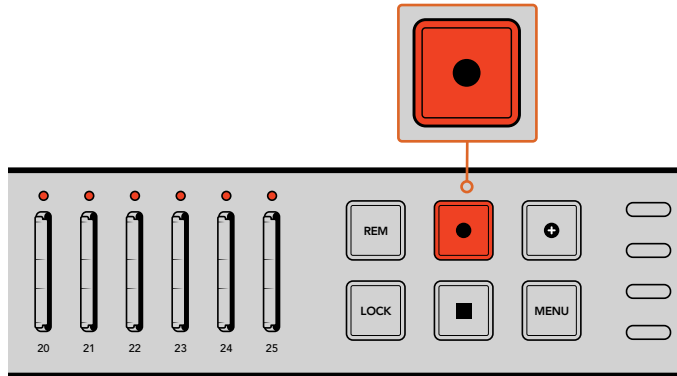

Press the 'record' button to start recording. The status LEDs above each slot will glow red to let you know the SD cards are recording.

LED Status Indicators

The status LEDs above each SD card slot will illuminate different colors to let you know the status of the slot. For example, when inserting an SD card, the slot's LED will illuminate green when the card has been recognized and is ready to record.

Below is a description of each LED color, LED action, and the status represented:



Constant green

Ready to record. The LED will glow green to indicate the SD card is ready to record.



Constant red

Recording. The LED will glow a constant red while a clip is being recorded.



Flashing red

Recording and card is almost full. The indicator will flash when there is less than 3 minutes of recording space remaining on the card.



Flashing red quickly

Dropping frames. The SD card write speed is not fast enough to match the recording speed.



Constant yellow

Card full, write-protected, or write failure. If you see the LED glow constant yellow during recording, it means your SD card may be bad, write-protected, not yet formatted, or have less than 10 seconds of space left. Try sliding the lock switch into the 'unlock' position, lowering the data rate, using a faster SD card, formatting it, or swapping it over to a different card.

Although the duplicator will attempt to keep the file system on each card organized and prepared in case a card is removed during recording, it's important you don't remove an SD card while your Blackmagic Duplicator 4K is recording. This is because some operating systems that could be used to view the card are not as robust as others and they might see the recording as being damaged. So it's always safer to stop recording before removing a card. If you do find that you want to be able to pass cards to people before a performance has completed, it might be a good idea to use multiple duplicators and then you can stop one unit early to distribute cards from that unit, while the other units keep recording.

TIP While SD cards with a class 10 speed rating can record using all data rates supported by your Blackmagic Duplicator 4K, you can also record lower data rates using cards with a slower rating if you need to. For example, you may wish to record security vision for long durations and don't need the highest video quality. We recommend always performing a test recording to make sure your SD card can record video at your chosen bit rate. For more information about SD card speed ratings, refer to 'inserting and formatting SD cards' in the Getting Started section.

Append Record

When recording in duplicate mode, you may wish to record a new clip, and add it to the previously recorded clip so they appear as one single clip. For example, you may be recording a performance with multiple separate events. If you want to record each event separately, but have them combined into one clip, this is how the 'append record' feature can help you.

- 1 Record the first clip as you normally would using the 'record' button. Press stop.
- 2 When the next event starts, press the 'append record' button. The button will be illuminated together with the standard 'record' button to let you know you are recording a clip that will be appended to the previously recorded clip.
- 3 Press stop. The new clip will then be appended to the first clip and they will be saved as one single clip.

TIP Using the 'append record' feature, there is no limit to the number of subsequent clips you can append to the first clip. The only consideration is the size of the card and length of the recordings.

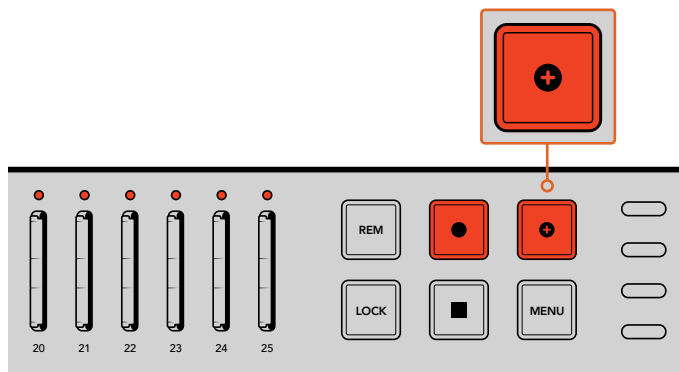

Press the 'append record' button to append a new clip to the previously recorded clip.

TIP When recording in single disk or single disk overwrite mode, you can press and hold the 'record' button for three seconds to shift the recording to the next card, freeing up the current card. This is helpful if you want to access an important event immediately after it happens without stopping recording. For more information on single disk and single disk overwrite modes, refer to the 'setting the recording mode' section. When recording in duplicate mode, you can press the 'append record' button. For more information, see the 'Append record' section.

Locking your Blackmagic Duplicator 4K

When recording an important event, you might want to lock the control panel so a recording cannot be accidentally stopped. It's also helpful to lock any daisy chained slave units so any controls on a unit cannot accidentally interrupt a recording.

Locking is enabled or disabled using the 'lock' button on each unit independently. Accidentally unlocking a unit is highly unlikely as you will need to physically hold the 'lock' button down for 2 seconds on each unit to unlock the controls.

To lock a Blackmagic Duplicator 4K:

- 1 Press the 'lock' button on your Blackmagic Duplicator 4K's control panel.
- 2 To unlock the unit, press and hold the 'lock' button. At the completion of 2 seconds, the unit will be unlocked.

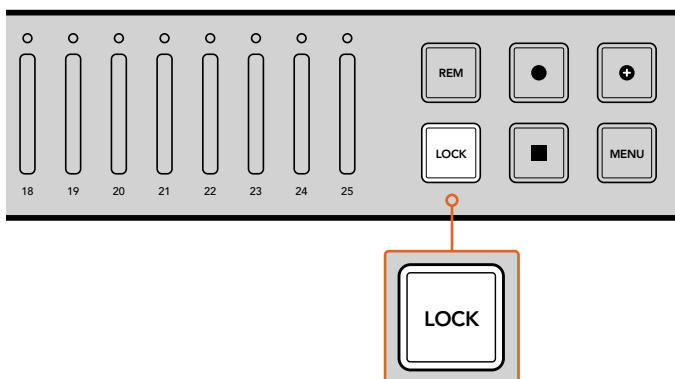

Locking your Blackmagic Duplicator 4K's control panel makes sure there is no risk of accidentally stopping a recording.

Daisy Chaining Multiple Duplicators

If you need to record to more than 25 SD cards, you can daisy chain multiple Blackmagic Duplicator 4Ks together. When daisy chained they will share the same video signal via the 'loop' SDI connector from each unit, plus communicate with each other via their 'remote' connectors using the RS-422 protocol.

To daisy chain multiple Blackmagic Duplicator 4Ks:

- 1 Connect the first unit's RS-422 'remote out' port to the second unit's 'remote in' port using a common serial cable with DB-9 connectors. Serial cables with DB-9 connectors are commonly available at your local computer or video equipment store.
- 2 Connect the 'loop' SDI output from the first unit to the second unit's SDI input.

It's really that easy! To daisy chain more Blackmagic Duplicator 4Ks, simply keep plugging each 'remote' and 'loop' output to the next unit's remote and SDI input all the way down the chain.

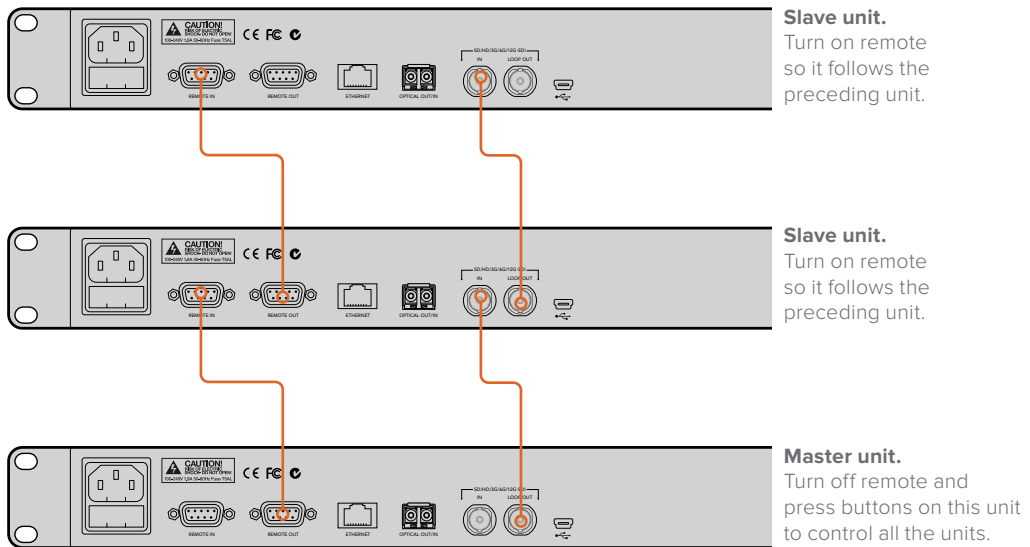

To daisy chain multiple Blackmagic Duplicator 4K's together, simply connect the loop output from one unit to the SDI input of the next unit. Similarly, connect the remote output from one unit to the remote input on the next.

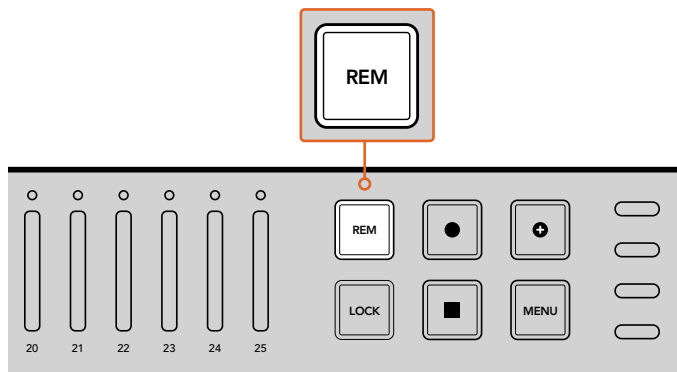

Press the remote button on each slave unit in the chain so they can be controlled remotely by the first unit.

NOTE Make sure you press the 'remote' button on each slave unit's control panel to enable remote control. The 'remote' button will illuminate when enabled. Press again to disable.

It's worth performing a test recording to make sure all the units are controlled by the master unit before the final recording. If the slave units are not conforming to the master unit, check the master unit has its remote button turned off and the slave units have their remote button turned on.

LCD Menu Settings

All the settings for your Blackmagic Duplicator 4K can be changed using the control panel LCD menu and soft buttons. The soft buttons are located on each side of the LCD and will illuminate corresponding to the settings displayed in the LCD menu.

To change a setting:

- 1 Press the 'menu' button on the control panel to open the LCD menu settings.
- 2 Use the menu soft buttons to navigate the menu.
- 3 Once you have selected your setting, press the 'change' menu soft button.
- 4 Adjust the setting, then press 'set' to confirm the change.

You can always cancel the change by pressing the 'back' menu soft button which will take you one step back in the menu sequence, or by simply pressing the 'menu' button on the control panel, which will return the LCD to the home screen.

Record

The 'record' settings lets you change the video source, set the bit rate, enable or disable trigger recording, and format your SD cards.

Video Source

This setting is used to select between the SDI input and the optical fiber input if you have the optical fiber SDI module installed.

Mode

Use this setting to select a recording mode:

Duplicate

Record the same video onto all SD cards at the same time.

Single Disk

Write to one SD card at a time, and when the SD card is full then continue on the next available SD card. When all cards are full, Duplicator 4K stops recording. If you have multiple units daisy chained together, recording continues to the next Duplicator 4K until all SD cards are full.

Single Disk Overwrite

Record a continual loop. Write to one SD card at a time, and when the SD card is full then continue on the next available SD card. When all cards are full, Duplicator 4K loops back to the first SD card and keeps recording.

Codec

Use this setting to set your Blackmagic Duplicator 4K to record using the H.264 and H.265 compression codecs.

Below is a description of the two different codecs.

H.264

Very commonly used compression offering a good compromise between image quality and file size. Most playback devices made in the last ten years will be able to view files compressed with this codec up to at least HD resolution.

H.265

Highly efficient compression capable of halving the size of video files for a given image quality compared to H.264. This codec is excellent for packaging high quality or Ultra HD video, but may need more up to date playback software and hardware to watch.

NOTE For more information on the difference between H.264 and H.265 see the 'recording' section of this manual.

Bit Rate

The bit rate setting determines how much video can be recorded to your SD cards and the quality of the video recording. There are three options you can choose.

High

Select 'high' when you want the highest quality video with the least compression.

Medium

Use the medium setting if you want to fit more video on your SD cards but also want to have very good image quality.

Low

Select 'low' if you want to fit the most video on your SD cards and you don't need the highest video quality. This setting will use the most compression so you may see visible compression artifacts in your recording.

NOTE The built in H.265 encoder uses the latest compression technology which means you get high quality video recordings using the least amount of data. Even at the lowest quality setting, with the most video compression, the quality of your recording will still be very good.

Bit Rates for Video Formats

Ultra HD			
Video Format	Bit Rate Setting	Bit Rate (Mb/s) H.264	Bit Rate (Mb/s) H.265
2160p60	High	75	50
	Medium	66	38
	Low	50	20
2160p59.94	High	75	50
	Medium	66	38
	Low	50	20

Ultra HD			
Video Format	Bit Rate Setting	Bit Rate (Mb/s) H.264	Bit Rate (Mb/s) H.265
2160p50	High	72	48
	Medium	61	32
	Low	42	16
2160p30	High	50	30
	Medium	37	20
	Low	24	10
2160p29.97	High	50	30
	Medium	37	20
	Low	24	10
2160p25	High	40	25
	Medium	32	18
	Low	20	10
2160p24	High	40	25
	Medium	32	18
	Low	20	10
2160p23.98	High	40	25
	Medium	32	18
	Low	20	10

HD			
Video Format	Bit Rate Setting	Bit Rate (Mb/s) H.264	Bit Rate (Mb/s) H.265
1080p60	High	40	20
	Medium	32	15
	Low	20	10
1080i60	High	40	20
	Medium	32	15
	Low	20	10
1080p59.94	High	40	20
	Medium	32	15
	Low	20	10
1080i59.94	High	40	20
	Medium	32	15
	Low	20	10
1080p50	High	36	20
	Medium	28	15
	Low	18	10

HD			
Video Format	Bit Rate Setting	Bit Rate (Mb/s) H.264	Bit Rate (Mb/s) H.265
1080i50	High	36	20
	Medium	28	15
	Low	18	10
1080p30	High	28	15
	Medium	20	11
	Low	11	7
1080p29.97	High	28	15
	Medium	20	11
	Low	11	7
1080p25	High	24	15
	Medium	16	10
	Low	9	6
1080p24	High	24	15
	Medium	15	10
	Low	8	6
1080p23.98	High	24	15
	Medium	15	10
	Low	8	6
720p60	High	25	12
	Medium	17	10
	Low	9	8
720p59.94	High	25	12
	Medium	17	10
	Low	9	8
720p50	High	20	12
	Medium	14	9
	Low	7	6

SD			
Video Format	Bit Rate Setting	Bit Rate (Mb/s) H.264	Bit Rate (Mb/s) H.265
625i50 PAL	High	18	11
	Medium	12	8
	Low	6	6
525i59.94 NTSC	High	20	12
	Medium	14	9
	Low	7	6

Trigger

The trigger setting enables the record trigger feature which lets you start recording on your Blackmagic Duplicator 4K triggered by the record button on other SDI equipment, for example Blackmagic URSA Mini.

None

Select 'none' to disable the trigger recording feature.

SDI Start/Stop

When SDI Start/Stop is selected, your Blackmagic Duplicator 4K can start recording when you press the record button on other SDI equipment.

For example, Blackmagic URSA Mini always sends a record trigger signal via the SDI outputs, so whenever you press record on your camera, your Blackmagic Duplicator 4K will start recording and then stop recording when you press the record button again. You don't need to adjust any settings to enable the trigger record feature on URSA Mini, however, if you are using other SDI equipment that supports trigger recording and you want to trigger the recording using that equipment, you will need to enable SDI start/stop trigger recording using your equipment's settings menu.

Timecode Run

If your SDI equipment doesn't support SDI start/stop trigger recording, you can set your Blackmagic Duplicator 4K to start recording as soon as it detects running timecode. For example, if you have an SDI camera connected to your Blackmagic Duplicator 4K and the camera is set to 'record run' timecode, it will trigger your Blackmagic Duplicator 4K to start recording as well. When you stop recording on your camera, the timecode will stop running and the recording will stop on your Blackmagic Duplicator 4K.

This is a terrific feature, but you will need to make sure your equipment's timecode setting is set to 'record run'. If the timecode setting is set to 'time of day', it will continually output running timecode and keep triggering record on your Blackmagic Duplicator 4K, which you probably don't want.

Format Cards

You can format up to 25 cards simultaneously using the format feature in your Blackmagic Duplicator 4K.

To format your cards:

- 1** Press the 'menu' button on the control panel to open the LCD menu.
- 2** Press the 'record' menu soft button to open the record settings.
- 3** Press the left or right arrow soft buttons to navigate to the 'format cards' setting and press 'format'.
- 4** A message will appear asking you to confirm the format. You will also see a warning that this action cannot be undone. If you have any data on your SD cards that you want to keep, make sure you back it up before proceeding with the action.
- 5** Press 'format' to confirm the action. You can also press 'cancel' and go back to the 'record' settings.
- 6** While your cards are formatting the status LED indicators will blink yellow and a progress bar will appear on the LCD. When the cards are formatted, the status indicators will remain green and the LCD menu will advise you that formatting is complete and your cards are now ready for recording.
- 7** Press OK. Then press the 'menu' button on the control panel to return to the home screen.

Settings

The 'settings' menu is used to change the network settings for your Blackmagic Duplicator 4K, such as DHCP on or off, IP address, subnet mask and gateway settings. Connecting your Blackmagic Duplicator 4K to a network lets you control the unit remotely using third party administration software such as Telnet.

DHCP 'ON'

To set your Blackmagic Duplicator 4K to automatically configure the best settings when connected to a network, select 'on'. This means your Blackmagic Duplicator 4K will check all the connected devices on the network and set its IP address and other network settings to avoid any potential settings conflicts. This is very reliable and an easy way to get your network settings working quickly.

DHCP 'OFF'

If you want to have full manual control over your network settings you can enter them manually by setting DHCP to 'off', then navigating through and changing the IP address, subnet mask and gateway settings.

IP Address, Subnet Mask and Gateway

When DHCP is set to 'off' you can manually change these settings.

To edit the number fields:

- 1 Select the number field you want to change using the left or right soft menu buttons and press 'change'.
- 2 Press the left and right soft menu buttons to increase or decrease the number value. You can hold the soft button down to move through them faster.
- 3 Press 'set' to confirm the change.

Now you can use the soft menu buttons to move through the rest of the sequence and make the changes you need.



The 'settings' LCD menu lets you change the network settings so you can control your Blackmagic Duplicator 4K using third party administration software such as Telnet.

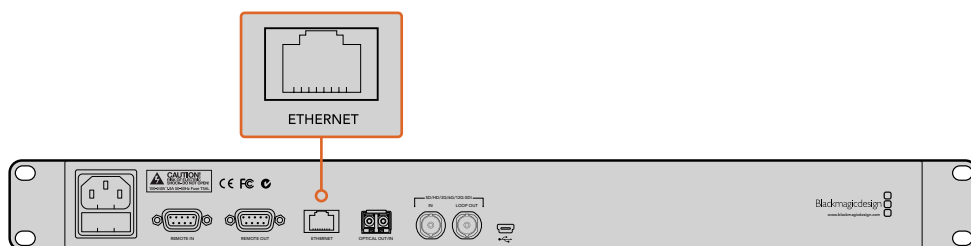

Plug your Blackmagic Duplicator 4K into your network via the Ethernet port on the rear panel.

About

This menu setting provides an instant overview showing you the current bit rate setting, file name of your latest recording, the network status and version of your Blackmagic Duplicator 4K's internal software.

Blackmagic Duplicator Utility

Updating your Blackmagic Duplicator 4K

Blackmagic Duplicator Utility software is used to update your Blackmagic Duplicator 4K's internal software, and to change the 'file name prefix' setting so you can label your recordings. We recommend downloading the software and updating your Blackmagic Duplicator 4K so you can benefit from new features and improvements.

The latest latest version can be downloaded from the Blackmagic Design support center at www.blackmagicdesign.com/support

To update the internal software using macOS:

- 1 Download and unzip Blackmagic Duplicator Utility.
- 2 Open the resulting disk image and launch the Blackmagic Duplicator Utility Installer. Follow the onscreen instructions.
- 3 After installing the latest Blackmagic Duplicator Utility, connect a USB cable from Blackmagic Duplicator 4K to your computer.
- 4 Launch Duplicator Utility and open the settings by clicking on the circular 'settings' icon. If the software detects an earlier version installed on your Blackmagic Duplicator 4K, it will display an 'update now' icon. Simply click on the icon to update the internal software. If your Blackmagic Duplicator 4K has the latest internal software installed, there is nothing more you need to do.

To update the internal software using Windows:

- 1 Download and unzip Blackmagic Duplicator Utility.
- 2 You should see a Blackmagic Duplicator Utility folder containing this manual and the Blackmagic Duplicator Utility installer. Double-click the installer and follow the onscreen prompts to complete the installation.
- 3 After installing the latest Blackmagic Duplicator Utility, connect a USB cable from your Blackmagic Duplicator 4K to your computer.
- 4 Launch Duplicator Utility and open the settings by clicking on the circular 'settings' icon. If the software detects an earlier version installed on your Blackmagic Duplicator 4K, it will display an 'update now' icon. Simply click on the icon to update the internal software. If your Blackmagic Duplicator 4K has the latest internal software installed, there is nothing more you need to do.

File Name Prefix

You can change the file name prefix so that your recordings can be labeled and easily identified. Simply click in the 'File Name Prefix' edit box and type in a new name. Now when your Blackmagic Duplicator 4K records the next clip, its file name will have a customized name followed by four digits to identify the clip number. These digits will increment with each recorded clip.

You can also make sure the recordings on all daisy chained units use the same file name by turning on the slave units remote buttons, then changing the file name prefix setting on the master unit. This lets you record clips and have all cards on all units share the same file name.

Installing the optional Optical Fiber SDI Module

If you want to plug in SDI video via optical fiber, you will need to install the optional optical fiber SDI module. Any SMPTE compatible SFP optical fiber module can be installed and can be purchased separately from any Blackmagic Design reseller. The module simply plugs into the built in optical fiber cage on your Blackmagic Duplicator 4K's rear panel. With the optical fiber SDI module installed you can connect SDI video with embedded audio over extremely long cable lengths. You can also use the optical output as an additional loop video connector.

If you are running lower speed optical fiber systems such as 3G-SDI or 6G-SDI optical fiber then you can install a slower module in this slot to save costs if you don't need the higher speeds.

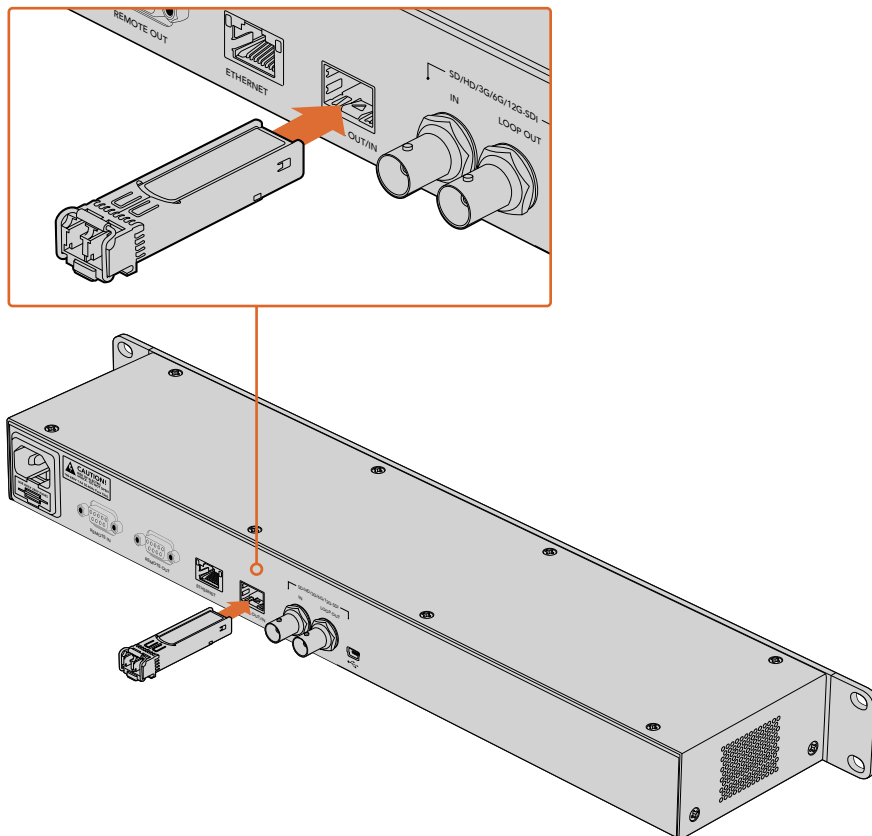

You can connect SDI video via optical fiber by installing the optional optical fiber SDI module.

Blackmagic Duplicator 4K will use whichever video connector was plugged in first, but if you have both SDI and optical fiber connected, you can select between them using the 'video source' setting in the LCD menu. For more information, refer to the 'settings' section.

RS-422 Control

What is RS-422 Control?

The RS-422 standard is a serial deck control broadcast standard and has been used by broadcasters since the early 1980s and is found on many decks, linear editors, non linear editors and broadcast automation products. Your Blackmagic Duplicator 4K supports this standard so can be integrated into broadcast automation, remote control systems, scheduled recording systems and any kind of custom control you might like to design yourself.

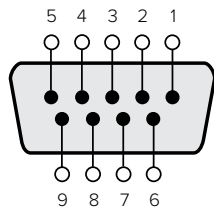

Transmit (-)	Transmit (+)	Receive (-)	Receive (+)	Ground Pins
2	7	8	3	1, 4, 6, 9

RS-422 remote pin connections for the remote input connector.

Using an External RS-422 Controller

Your Blackmagic Duplicator 4K features an industry standard Sony(tm) compatible 'remote' RS-422 deck control port, which has the correct pin connections for a direct connection to any remote controller with RS-422.

You can use pre-manufactured 9 pin cables as long as each end of the cable is wired 'pin for pin' where the same pin numbers on each end of the cable are connected together. If your equipment is wired differently and you would like to make custom cables, please refer to the accompanying remote input wiring diagram so you can make sure the transmit, or Tx, pins are wired to the receive, or Rx, pins.

By connecting an external RS-422 controller to your Blackmagic Duplicator 4K, you can control the unit remotely instead of pushing buttons locally.

- 1 Connect an RS-422 cable from your external controller to your Blackmagic Duplicator 4K's remote input.
- 2 Press the remote button marked 'REM' on your Blackmagic Duplicator 4K's control panel to enable remote deck control.

You can now start and stop recording, or start and stop an append record with your Blackmagic Duplicator 4K remotely. A full list of supported RS-422 commands are provided in the following section named 'supported RS-422 commands'.

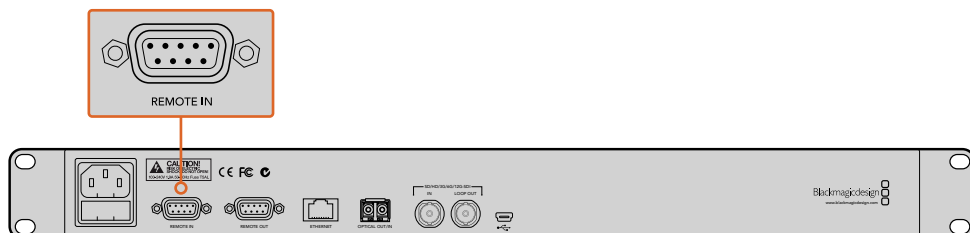

Connect an external RS-422 controller to Blackmagic Duplicator 4K's remote input to control the unit remotely.

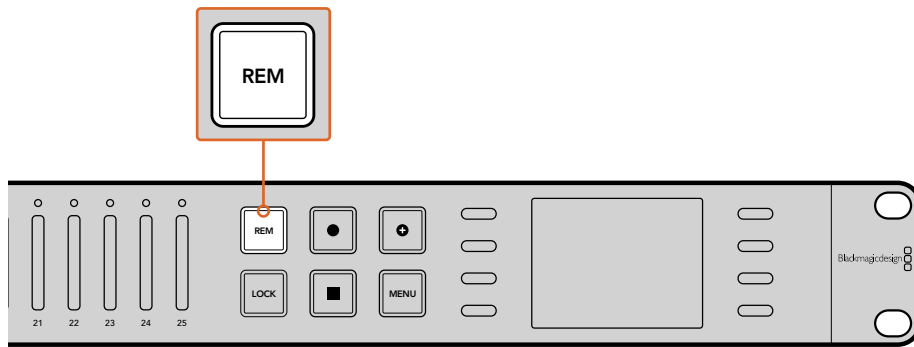

Press the remote button on your Blackmagic Duplicator 4K's control panel to enable RS-422 deck control.

Supported RS-422 Commands

		Command	Reply	No Remote	Notes
0 - System Control					
0x00	0x11	DeviceTypeRequest	NTSC: 0xF0E0 PAL: 0xF1E0 24P: 0xF2E0	Enabled	–

1 - Slave Response					
0x20	0x00	Stop	Acknowledge	Disabled	–
0x20	0x02	Record	Acknowledge	Disabled	–
0x21	0x02	Append	Acknowledge	Disabled	Non-standard command - an extra payload of 0x00 indicates append

4 - Preset/Select Control					
0x40	0x40	AutoMode Off	Acknowledge	Disabled	ignored, Status bit remembered
0x40	0x41	AutoMode On	Acknowledge	Disabled	ignored, Status bit remembered
0x61	0x20	StatusSense	StatusData	Enabled	–

7 - Sense Reply					
0x70	0x20	StatusData	–	–	Please see "Status Bits" sheet: Limited to 9 bytes of status, silently truncated

RS-422 Developer Information

	Bit 7	Bit 6	Bit 5	Bit 4	Bit 3	Bit 2	Bit 1	Bit 0
Byte 0	0	0	Cassette out	0	0	0	0	Local
Byte 1	Standby	0	Stop	0	0	0	Record	0
Byte 2	0	0	0	0	0	0	0	0
Byte 3	Auto Mode	0	0	0	0	0	0	0
Byte 4	Select EE	Full EE	0	0	0	0	0	0
Byte 5	0	0	0	0	0	0	0	0
Byte 6	0	0	0	0	0	0	0	0
Byte 7	0	0	0	0	0	0	0	0
Byte 8	0	0	0	0	0	0	0	0
Byte 9	0	0	0	0	0	0	0	0

Variables	
Cassette Out	Set if no cards are ready to record
Local	Set if in local mode (no remote control)
Standby	Set if one or more cards are ready to record
Auto Mode	For compatibility only
Full EE	For compatibility only - always on
Select EE	For compatibility only - always on

Blackmagic Duplicator 4K RS-422 Settings	
Protocol	Based on Sony 9-pin protocol
Baud Rate	38.4 K
Start Bits	1
Data Bits	8
Stop Bits	1
Parity Bits	1
Parity Type	Odd

Remote Control via Ethernet

Your Blackmagic Duplicator 4K can be controlled externally via Ethernet using text based commands from the Blackmagic HyperDeck Ethernet Protocol. This gives you the ability to control your Blackmagic Duplicator 4K remotely from a computer using administration software such as Telnet, or you can custom build your own hardware control panel and program it to integrate with your Blackmagic Duplicator 4K using the HyperDeck Ethernet Protocol.

You can develop your own custom solutions to control your duplicator from computers or dedicated hardware control devices or large systems used in broadcast studios or trucks. For example, Arduino microcontrollers are small circuit boards that can be customized with expansion boards called 'shields'. There are many types of shields and they can house different connectors. To control your Blackmagic Duplicator 4K an Ethernet shield is required. You can even buy additional shields with programmable buttons! Arduino microcontrollers are easy to set up, very affordable and are completely open source. After programming the Arduino software, you can simply connect the Arduino to your Blackmagic Duplicator 4K's Ethernet port and start controlling your duplicator immediately.

An Example of Controlling via an Arduino

Arduino microcontrollers are programmed using common C programming language. Simply program your controller to trigger commands to your Blackmagic Duplicator 4K using the HyperDeck Ethernet Protocol. All supported commands are shown in the following section named "Blackmagic HyperDeck Ethernet Protocol".

You can add other expansion shields to your Arduino so you can perform various recording functions. For example, if you add an internal clock, you can program your controller to instruct Blackmagic Duplicator 4K to record at specific times of the day, which may be helpful if you are scheduling security recordings.

We are excited by this technology and would love to hear about any external Ethernet controllers you have built!

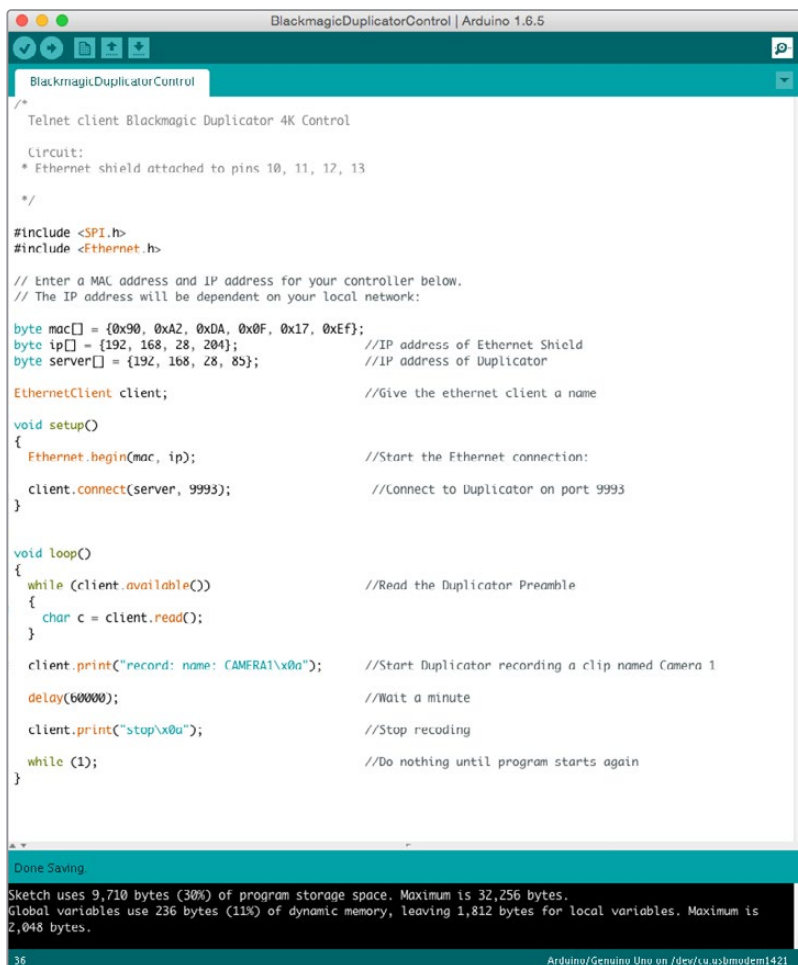

```
BlackmagicDuplicatorControl | Arduino 1.6.5
BlackmagicDuplicatorControl
/*
 * Telnet client Blackmagic Duplicator 4K Control
 *
 * Circuit:
 * Ethernet shield attached to pins 10, 11, 12, 13
 */
#include <SPI.h>
#include <Ethernet.h>

// Enter a MAC address and IP address for your controller below.
// The IP address will be dependent on your local network:
byte mac[] = {0x90, 0xA2, 0xDA, 0x0F, 0x17, 0xEF};
byte ip[] = {192, 168, 28, 204}; //IP address of Ethernet Shield
byte server[] = {192, 168, 28, 85}; //IP address of Duplicator

EthernetClient client; //Give the ethernet client a name

void setup()
{
  Ethernet.begin(mac, ip); //Start the Ethernet connection:
  client.connect(server, 9993); //Connect to Duplicator on port 9993
}

void loop()
{
  while (client.available()) //Read the Duplicator Preamble
  {
    char c = client.read();
  }

  client.print("record: name: CAMFRA1\x0a"); //Start Duplicator recording a clip named Camera 1
  delay(60000); //Wait a minute
  client.print("stop\x0a"); //Stop recoding
  while (1); //Do nothing until program starts again
}
```

Done Saving

Sketch uses 9,710 bytes (30%) of program storage space. Maximum is 32,256 bytes.
Global variables use 236 bytes (11%) of dynamic memory, leaving 1,812 bytes for local variables. Maximum is 2,048 bytes.

36 Arduino/Genuino Uno on /dev/tty.usbmodem1421

When programming an external Ethernet controller, such as this example of using an Arduino with an Ethernet shield, then you simply use the Ethernet protocol reference here to select which commands you need to use to get the control you desire.

The code shown in the window above is also presented on the next page so you can copy and paste it into your Arduino IDE. The code programs the Arduino to instruct Blackmagic Duplicator 4K to record for 1 minute, then stop recording and wait until the program runs again.

```

/*
   Telnet client Blackmagic Duplicator 4K Control Circuit: *
Ethernet shield attached to pins 10, 11, 12, 13
*/
#include <SPI.h>
#include <Ethernet.h>

// Enter a MAC address and IP address for your controller below.
// The IP address will be dependent on your local network:
byte mac[] = {0x90, 0xA2, 0xDA, 0x0F, 0x17, 0xEF};
byte ip[] = {192, 168, 28, 204};           // IP address of
Ethernet Shield
byte server[] = {192, 168, 28, 141};      // IP address of Duplicator
EthernetClient client;                   // Give the ethernet
client a name

void setup()
{
  Ethernet.begin(mac, ip);               //Start the Ethernet connection:

  client.connect(server, 9993);           //Connect to Duplicator on port 9993
}

void loop()
{
  while (client.available()) //Read the Duplicator Preamble
  {
    char c = client.read();
  }

  client.print("record: name: Camera1\r\n");
  //Start Duplicator recording a clip named Camera 1
  delay(60000);                          //Wait a minute
  client.print("stop\r\n");               //Stop recoding
  while (1);                              //Do nothing until program
starts again
}

```

Blackmagic HyperDeck Ethernet Protocol

The Blackmagic HyperDeck Ethernet Protocol is a text based protocol that was originally written for controlling Blackmagic HyperDeck disk recorders via the Ethernet port, but you can also use the same protocol to control your Blackmagic Duplicator 4K.

Because the duplicator only records, it does not have the full command set of the HyperDeck protocol, however this section shows the commands available that are relevant when using the HyperDeck Ethernet protocol on the duplicator.

Protocol Commands

Command	Command Description
help or ?	Provides help text with all commands and parameters.
remote	Queries the state of HyperDeck's remote control mode.
remote: enable: true	Enables remote control.
remote: enable: false	Disables remote control.
remote: override: true	Turns remote override on.
remote: override: false	Turns remote override off.
quit	Disconnects HyperDeck server.
ping	Determines HyperDeck server is responding.
record	Starts recording.
record: append: true	Starts appended recording.
stop	Stops playback or recording.
commands	Lists all supported commands in an XML format.
notify	Queries the current state of all notifications.
notify: transport: true	Enables transport notifications.
notify: transport: false	Disables transport notifications.
notify: slot: true	Enables slot notifications.
notify: slot: false	Disables slot notifications.
notify: remote: true	Enables remote notifications.
notify: remote: false	Disables remote notifications.
notify: configuration: true	Enables configuration notifications.
notify: configuration: false	Disables configuration notifications.
notify: dropped frames: true	Enables dropped frames notifications.
notify: dropped frames: false	Disables dropped frames notifications.
device info	Provides device information.
slot info: slot id: {slot ID}	Provides information about a specified slot.
transport info	Provides information for the state of the transport.
configuration	Queries the current configuration.
configuration: record mode: Duplicate	Configures the record mode to duplicate.

Command	Command Description
configuration: record mode: SingleDisk	Configures the record mode to single disk.
configuration: record mode: DiskOverwrite	Configures the record mode to disk overwrite.
configuration: video input: {"SDI", "optical"}	Configures video input.
configuration: file format: {format}	Configures the record codec and bit rate.
format: prepare: {format}	prepare a disk formatting operation to filesystem {format}
format: confirm: {token}	perform a pre-prepared formatting operation using token
watchdog: period: {seconds}	Configures the watchdog.

Using XML

While you can use the Terminal to talk to HyperDeck, if you are writing software you can use XML to confirm the existence of a specific command based on the firmware of the HyperDeck you are communicating with. This helps your software user interface adjust to the capabilities of the specific HyperDeck model and software version.

Protocol Details

Connection

The HyperDeck Ethernet server listens on TCP port 9993.

Basic syntax

The HyperDeck protocol is a line oriented text protocol. Lines from the server will be separated by an ASCII CR LF sequence. Messages from the client may be separated by LF or CR LF.

New lines are represented in this document as a "`\n`" symbol.

Command syntax

Command parameters are usually optional. A command with no parameters is terminated with a new line:

```
{Command name}\n
```

If parameters are specified, the command name is followed by a colon, then pairs of parameter names and values. Each parameter name is terminated with a colon character:

```
{Command name}: {Parameter}: {Value} {Parameter}: {Value} ...\n
```

Response syntax

Simple responses from the server consist of a three digit response code and descriptive text terminated by a new line:

```
{Response code} {Response text}\n
```

If a response carries parameters, the response text is terminated with a colon, and parameter name and value pairs follow on subsequent lines until a blank line is returned:

```
{Response code} {Response text}:\n
{Parameter}: {Value}\n
{Parameter}: {Value}\n
...
\n
```

Successful response codes

A simple acknowledgement of a command is indicated with a response code of 200:

```
200 ok\n
```

Other successful responses carry parameters and are indicated with response codes in the range of 201 to 299.

Failure response codes

Failure responses to commands are indicated with response codes in the range of 100 to 199:

```
100 syntax error
101 unsupported parameter
102 invalid value
103 unsupported
104 disk full
105 no disk
106 disk error
109 out of range
110 no input
111 remote control disabled
120 connection rejected
150 invalid state
```

Asynchronous response codes

The server may return asynchronous messages at any time. These responses are indicated with response codes in the range of 500 to 599:

```
5xx {Response Text}:↵
{Parameter}: {Value}↵
{Parameter}: {Value}↵
↵
```

Connection response

On connection, an asynchronous message will be delivered:

```
500 connection info:↵
protocol version: {Version}↵
model: {Model Name}↵
↵
```

Connection rejection

Only one client may connect to the server at a time. If other clients attempt to connect concurrently, they will receive an error and be disconnected:

```
120 connection rejected↵
```

Timecode syntax

Timecodes are expressed as non-drop-frame timecode in the format:

```
HH:MM:SS:FF
```

Handling of deck "remote" state

The "remote" command may be used to enable or disable the remote control of the deck. Any attempt to change the deck state over ethernet while remote access is disabled will generate an error:

```
111 remote control disabled↵
```

To enable or disable remote control:

```
remote: enable: {"true", "false"} ↵
```

The current remote control state may be overridden allowing remote access over ethernet irrespective of the current remote control state:

```
remote: override: {"true", "false"} ↵
```

The override state is only valid for the currently connected ethernet client and only while the connection remains open.

The "remote" command may be used to query the remote control state of the deck by specifying no parameters:

```
remote↵
```

The deck will return the current remote control state:

```
210 remote info:↵
enabled: {"true", "false"}↵
override: {"true", "false"}↵
↵
```

Asynchronous remote control information change notification is disabled by default and may be configured with the "notify" command. When enabled, changes in remote state will generate a "510 remote info:" asynchronous message with the same parameters as the "210 remote info:" message.

Closing connection

The "quit" command instructs the server to cleanly shut down the connection:

```
quit↵
```

Checking connection status

The "ping" command has no function other than to determine if the server is responding:

```
ping↵
```

Getting help

The "help" or "?" commands return human readable help text describing all available commands and parameters:

```
help↵
```

or:

```
?↵
```

The server will respond with a list of all supported commands:

```
201 help:↵
{Help Text}↵
{Help Text}↵
↵
```

Stopping deck operation

The "stop" command instructs the deck to stop the current capture:

```
stop↵
```

Enumerating supported commands and parameters

The "commands" command returns the supported commands:

```
commands↵
```

The command list is returned in a computer readable XML format:

```
212 commands:
<commands>↵
    <command name="..."><parameter name="...">...</command>↵
    <command name="..."><parameter name="...">...</command>↵
    ...
</commands>↵
↵
```

More XML tokens and parameters may be added in later releases.

Controlling asynchronous notifications

The "notify" command may be used to enable or disable asynchronous notifications from the server. To enable or disable transport notifications:

```
notify: transport: {"true", "false"}↵
```

To enable or disable slot notifications:

```
notify: slot: {"true", "false"}↵
```

To enable or disable remote notifications:

```
notify: remote: {"true", "false"}↵
```

To enable or disable configuration notifications:

```
notify: configuration: {"true", "false"}↵
```

To enable or disable dropped frames notifications:

```
notify: dropped frames: {"true", "false"}↵
```

Multiple parameters may be specified. If no parameters are specified, the server returns the current state of all notifications:

```
209 notify:↵  
transport: {"true", "false"}↵  
slot: {"true", "false"}↵  
remote: {"true", "false"}↵  
configuration: {"true", "false"}↵  
↵
```

Retrieving device information

The "device info" command returns information about the connected deck device:

```
device info↵
```

The server will respond with:

```
204 device info:↵  
protocol version: {Version}↵  
model: {Model Name}↵  
unique id: {unique alphanumeric identifier}↵  
↵
```

Example of response from server:

```
204 device info:↵  
protocol version: 1.8↵  
model: Blackmagic Duplicator 4K↵  
unique id: 101112131415↵  
↵
```

Retrieving slot information

The "slot info" command returns information about a slot.

The specified slot will be queried:

```
slot info: slot id: {Slot ID}↵
```

The server will respond with slot specific information:

```
202 slot info:↵  
slot id: {Slot ID}↵  
status: {"empty", "mounting", "error", "mounted"}↵  
volume name: {Volume name}↵  
recording time: {recording time available in seconds}↵  
video format: {disk's default video format}↵  
↵
```

Asynchronous slot information change notification is disabled by default and may be configured with the “notify” command. When enabled, changes in slot state will generate a “502 slot info:” asynchronous message with the same parameters as the “202 slot info:” message.

Retrieving transport information

The “transport info” command returns the state of the transport:

```
transport info ↵
```

The server responds with transport specific information:

```
208 transport info:↵
status: {"stopped","record"}↵
display timecode: {timecode}↵
timecode: {timecode}↵
```

The “timecode” value is the timecode within the current timeline for playback or the clip for record. The “display timecode” is the timecode displayed on the front of the deck. The two timecodes will differ in some deck modes.

Asynchronous transport information change notification is disabled by default and may be configured with the “notify” command. When enabled, changes in transport state will generate a “508 transport info:” asynchronous message with the same parameters as the “208 transport info:” message.

Video Formats

The following video formats are currently supported on Blackmagic Duplicator 4K:

SD

525i59.94 NTSC
625i50 PAL

HD

720p50	1080p30
720p59.94	1080i50
720p60	1080p50
1080p23.98	1080i59.94
1080p24	1080p59.94
1080p25	1080i60
1080p29.97	1080p60

Ultra HD

2160p23.98	2160p30
2160p24	2160p50
2160p25	2160p59.94
2160p29.97	2160p60

Duplicator 4K supports progressive segmented frame modes, and automatically detects level A and level B 3G-SDI formats for 1080p50, 1080p59.94 and 1080p60.

File Formats

Duplicator 4K supports the following file formats:

- H.264Low
- H.264Medium
- H.264High
- H.265Low
- H.265Medium
- H.265High

Querying and updating configuration information

The "configuration" command may be used to query the current configuration of the deck:

```
configuration↵
```

The server returns the configuration of the deck:

```
211 configuration:↵  
video input: {"SDI", "optical"}↵  
↵
```

One or more configuration parameters may be specified to change the configuration of the deck.

To change the current video input:

```
configuration: video input: {"SDI", "optical"}↵
```

Configuring the watchdog

The "watchdog" command instructs the deck to monitor the connected client and terminate the connection if the client is inactive for at least a specified period of time.

To configure the watchdog:

```
watchdog: period: {period in seconds}↵
```

To avoid disconnection, the client must send a command to the server at least every {period} seconds. Note that if the period is set to 0 or less than 0, connection monitoring will be disabled.

Configuring the record mode

Use the 'record mode' command to select the deck recording mode:

```
configuration: record mode: {"Duplicate", "SingleDisk", "DiskOverwrite"}↵
```

Configuring the file format

The 'file format' command instructs the deck to switch to a specific file format for codec and bit rate:

```
configuration: file format: {"H.264High", "H.264Medium", "H.264Low",  
"H.265High", "H.265Medium", "H.265Low"}↵
```

Help

Getting Help

The fastest way to obtain help is to go to the Blackmagic Design online support pages and check the latest support material available for your Blackmagic Duplicator 4K.

Blackmagic Design Online Support Pages

The latest manual, software and support notes can be found at the Blackmagic Design support center at www.blackmagicdesign.com/support.

Blackmagic Design Forum

The Blackmagic Design forum on our website is a helpful resource you can visit for more information and creative ideas. This can also be a faster way of getting help as there may already be answers you can find from other experienced users and Blackmagic Design staff which will keep you moving forward. You can visit the forum at <https://forum.blackmagicdesign.com>

Contacting Blackmagic Design Support

If you can't find the help you need in our support material or on the forum, please use the "Send us an email" button on the support page to email a support request. Alternatively, click on the "Find your local support team" button on the support page and call your nearest Blackmagic Design support office.

Checking the Software Version Currently Installed

To check which version of Blackmagic Duplicator Utility software is installed on your computer, open the About Blackmagic Duplicator Utility window.

- On macOS, open Blackmagic Duplicator Utility from the Applications folder. Select About Blackmagic Duplicator Utility from the application menu to reveal the version number.
- On Windows 8.1, open Blackmagic Duplicator Utility from the Blackmagic Duplicator Utility tile on your Start page. Click on the Help menu and select About Blackmagic Duplicator Utility to reveal the version number.
- On Windows 10, open Blackmagic Duplicator Utility from your Start menu. Click on the Help menu and select About Blackmagic Duplicator Utility to reveal the version number.

How to Get the Latest Software Updates

After checking the version of Blackmagic Duplicator Utility software installed on your computer, please visit the Blackmagic Design support center at www.blackmagicdesign.com/support to check for the latest updates. While it is usually a good idea to run the latest updates, it is wise to avoid updating any software if you are in the middle of an important project.

Regulatory Notices

Disposal of Waste of Electrical and Electronic Equipment Within the European Union.



The symbol on the product indicates that this equipment must not be disposed of with other waste materials. In order to dispose of your waste equipment, it must be handed over to a designated collection point for recycling. The separate collection and recycling of your waste equipment at the time of disposal will help conserve natural resources and ensure that it is recycled in a manner that protects human health and the environment. For more information about where you can drop off your waste equipment for recycling, please contact your local city recycling office or the dealer from whom you purchased the product.



This equipment has been tested and found to comply with the limits for a Class A digital device, pursuant to Part 15 of the FCC rules. These limits are designed to provide reasonable protection against harmful interference when the equipment is operated in a commercial environment. This equipment generates, uses, and can radiate radio frequency energy and, if not installed and used in accordance with the instructions, may cause harmful interference to radio communications. Operation of this product in a residential area is likely to cause harmful interference, in which case the user will be required to correct the interference at personal expense.

Operation is subject to the following two conditions:

- 1 This device may not cause harmful interference.
- 2 This device must accept any interference received, including interference that may cause undesired operation.

ISED Canada Statement

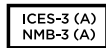

This device complies with Canadian standards for Class A digital apparatus.

Any modifications or use of this product outside its intended use could void compliance to these standards.

This equipment has been tested for compliance with the intended use in a commercial environment. If the equipment is used in a domestic environment, it may cause radio interference.

Safety Information

For protection against electric shock, the equipment must be connected to a mains socket outlet with a protective earth connection. In case of doubt contact a qualified electrician.

To reduce the risk of electric shock, do not expose this equipment to dripping or splashing.

Product is suitable for use in tropical locations with an ambient temperature of up to 40°C.

Ensure that adequate ventilation is provided around the product and that it is not restricted.

When rack mounting, ensure that the ventilation is not restricted by adjacent equipment.

No operator serviceable parts inside product. Refer servicing to your local Blackmagic Design service center.

Some products have the facility to connect small form-factor transceiver (SFP) optical fibre modules. Only use Laser class 1 optical SFP modules.

Recommended Blackmagic Design SFP modules:

- **3G-SDI:** PL-4F20-311C
- **6G-SDI:** PL-8F10-311C
- **12G-SDI:** PL-TG10-311C



Use only at altitudes not more than 2000m above sea level.

State of California statement

This product can expose you to chemicals including hexavalent chromium, which is known to the state of California to cause cancer and birth defects or other reproductive harm.

For more information go to www.P65Warnings.ca.gov.

Warning for Authorized Service Personnel

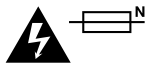

Caution — Double Pole/ Neutral Fusing

The power supply contained in this equipment has a fuse in both line and neutral conductors and is suitable for connection to the IT power distribution system in Norway.

Warranty

12 Month Limited Warranty

Blackmagic Design warrants that the Blackmagic Duplicator 4K product will be free from defects in materials and workmanship for a period of 12 months from the date of purchase. If a product proves to be defective during this warranty period, Blackmagic Design, at its option, either will repair the defective product without charge for parts and labor, or will provide a replacement in exchange for the defective product.

In order to obtain service under this warranty, you the Customer, must notify Blackmagic Design of the defect before the expiration of the warranty period and make suitable arrangements for the performance of service. The Customer shall be responsible for packaging and shipping the defective product to a designated service center nominated by Blackmagic Design, with shipping charges pre paid. Customer shall be responsible for paying all shipping charges, insurance, duties, taxes, and any other charges for products returned to us for any reason.

This warranty shall not apply to any defect, failure or damage caused by improper use or improper or inadequate maintenance and care. Blackmagic Design shall not be obligated to furnish service under this warranty: a) to repair damage resulting from attempts by personnel other than Blackmagic Design representatives to install, repair or service the product, b) to repair damage resulting from improper use or connection to incompatible equipment, c) to repair any damage or malfunction caused by the use of non Blackmagic Design parts or supplies, or d) to service a product that has been modified or integrated with other products when the effect of such a modification or integration increases the time or difficulty of servicing the product. THIS WARRANTY IS GIVEN BY BLACKMAGIC DESIGN IN LIEU OF ANY OTHER WARRANTIES, EXPRESS OR IMPLIED. BLACKMAGIC DESIGN AND ITS VENDORS DISCLAIM ANY IMPLIED WARRANTIES OF MERCHANTABILITY OR FITNESS FOR A PARTICULAR PURPOSE. BLACKMAGIC DESIGN'S RESPONSIBILITY TO REPAIR OR REPLACE DEFECTIVE PRODUCTS IS THE WHOLE AND EXCLUSIVE REMEDY PROVIDED TO THE CUSTOMER FOR ANY INDIRECT, SPECIAL, INCIDENTAL OR CONSEQUENTIAL DAMAGES IRRESPECTIVE OF WHETHER BLACKMAGIC DESIGN OR THE VENDOR HAS ADVANCE NOTICE OF THE POSSIBILITY OF SUCH DAMAGES. BLACKMAGIC DESIGN IS NOT LIABLE FOR ANY ILLEGAL USE OF EQUIPMENT BY CUSTOMER. BLACKMAGIC IS NOT LIABLE FOR ANY DAMAGES RESULTING FROM USE OF THIS PRODUCT. USER OPERATES THIS PRODUCT AT OWN RISK.

© Copyright 2019 Blackmagic Design. All rights reserved. 'Blackmagic Design', 'DeckLink', 'HDLink', 'Workgroup Videohub', 'Videohub', 'DeckLink', 'Intensity' and 'Leading the creative video revolution' are registered trademarks in the US and other countries. All other company and product names may be trade marks of their respective companies with which they are associated. Thunderbolt and the Thunderbolt logo are trademarks of Intel Corporation in the U.S. and/or other countries.

Blackmagicdesign



インストール/オペレーション マニュアル

Blackmagic Duplicator 4K

2019年2月

日本語



ようこそ

このたびはBlackmagic Duplicator 4Kをお買い求めいただき誠にありがとうございました。

私たちはこの製品を皆様にご利用いただけることを大変嬉しく思っております。Blackmagic Duplicator 4Kは、高品質Ultra HDのコンテンツを直接提供・配布する際に最適なソリューションです。Blackmagic Duplicator 4Kでは幅広く使用されているH.264や最新のH.265圧縮を使用して、2160p60までのSD、HD、Ultra HDビデオを25枚のSDカードに同時に収録できます。優れた画質、高フレームレートでありながらデータレートが低いため、廉価なカードを使用できるだけでなく、長時間の収録にも対応できます。

Blackmagic Duplicator 4Kは、セットアップおよび使用も簡単です。フロントパネルにはLCDとコントロールパネルを搭載しており、ボタンを使用して設定の変更やユニットのコントロールが可能です。さらにRS-422コントローラーを接続すれば、イーサネット経由でBlackmagic Duplicator 4Kをリモートコントロールできます。独自のコントローラーをカスタムメイドで作り、Blackmagic HyperDeck Ethernet Protocolでユニットをコントロールすることも可能です。

内蔵のリアルタイムH.265ビデオエンコーダーは、高品質ビデオをUltra HD 2160p60までのビデオフォーマットで廉価のSDカードに収録します。極めて優れた画質のUltra HDビデオを収録する場合でも、最も高速のカードを使用する必要はありません。最新のBlackmagic Duplicator 4Kのバージョン1.2は、H.264圧縮に対応しているため、H.264ファイルで収録し、一層幅広い互換性を得られます。

Blackmagic Duplicator 4Kは1Uラックサイズです。ポータブルラックで複数のユニットをデジチェーン接続し、撮影現場に持ち込めば、100枚以上のSDカードに同時収録することも可能です。

このマニュアルには、Blackmagic Duplicator 4Kの使用において必要な情報がすべて記載されています。

弊社ウェブサイト www.blackmagicdesign.com/jp のサポートページで、同マニュアルの最新バージョンおよびBlackmagic Duplicator 4Kソフトウェアの最新アップデートを確認してください。ソフトウェアをアップデートすることで、常に最新の機能をお使いいただけます。ソフトウェアをダウンロードする際にデータを登録いただければ、新しいソフトウェアのリリース時にお客様にお知らせいたします。私たちは常に新機能の開発および製品の改善に努めていますので、ユーザーの皆様からご意見をいただければ幸いです。

Blackmagic Design CEO

グラント・ペティ

目次

Blackmagic Duplicator 4K

はじめに	42
電源の接続	42
ビデオ/オーディオの接続	42
デイジーチェーン	43
SDカードの挿入/フォーマット	44
収録	45
収録モードの設定	45
コーデックの設定	46
ビットレートの設定	47
クリップの収録	48
LEDステータスインジケータ	48
アベンド収録	49
Blackmagic Duplicator 4Kのロック	50
複数のユニットをデイジーチェーン接続	50
LCDメニュー設定	52
収録 (Record)	52
設定 (Settings)	57
ご使用のユニットについて (About)	58
Blackmagic Duplicator Utility	58
Blackmagic Duplicator 4Kをアップデート	58
ファイル名プレフィックス	58
オプションのOptical Fiber SDI Moduleをインストール	59
RS-422コントロール	60
RS-422とは?	60
外部RS-422コントローラーを使用する	60
RS-422 Developer Information	62
イーサネット経由でリモートコントロール	62
Arduinoを使用したコントロールの例	63
Blackmagic HyperDeck Ethernet Protocol	65
Protocol Commands	65
Protocol Details	66
Configuring the watchdog	71
Configuring the record mode	71
Configuring the file format	71
ヘルプ	72
規制に関する警告	73
安全情報	74
保証	75

はじめに

Blackmagic Duplicator 4Kの使用は簡単です！

必要な作業は、電源を差し込み、SDIビデオソースを接続して、最大25枚までのSDカードを挿入するだけです。それ以上の数のSDカードに収録したい場合は、複数のBlackmagic Duplicator 4Kをデジチェーンで接続してください。ビデオ/コントロール用のコネクタが搭載されているので、デジチェーンの次のユニットへの接続は簡単です。このセクションでは、Blackmagic Duplicator 4Kのセットアップ方法を細かく説明します。その後、複数のSDカードへの同時収録をすぐにご利用いただけます。

電源の接続

Blackmagic Duplicator 4Kに電源を供給するには、リアパネルの110-240V AC電源入力に標準IEC電源コードを差し込みます。

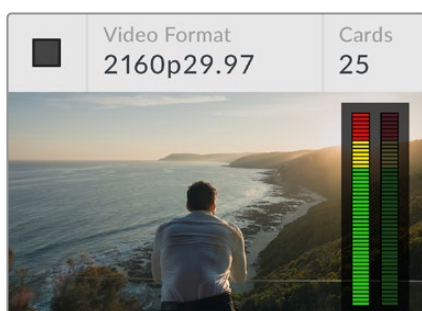

Blackmagic Duplicator 4Kに電源が入ると、内蔵LCDにホームスクリーンが表示されます。

ホームスクリーン

ホームスクリーンには、ソースビデオのイメージ、ソースビデオのフォーマット、挿入されているSDカードの数、現在収録中であるかどうかを示すステータスインジケータが表示されます。またオーディオメーターも表示されるため、ソースビデオのオーディオレベルも確認できます。

ビデオ/オーディオの接続

ソースビデオは、リアパネルの12G-SDI入力に接続します。Blackmagic Duplicator 4Kは入力フォーマットを自動的に検出し、LCDのホームスクリーンに表示します。

SDIの入出力に使用するBNCコネクタは12G-SDIまでのビデオ信号をサポートしており、1本のBNCケーブルで2160p60までのSD、HD、Ultra HDビデオに対応できます。ループ出力はソースビデオのフォーマットと常に一致しているため、他のSDIビデオ機器やデジチェーン接続したBlackmagic Duplicator 4Kに、同じ信号を送信できます。また、プログレッシブ・セグメント・フレームモードにも対応しており、1080p50、1080p59.94、1080p60の3G-SDI Level AおよびLevel Bを自動検出します。

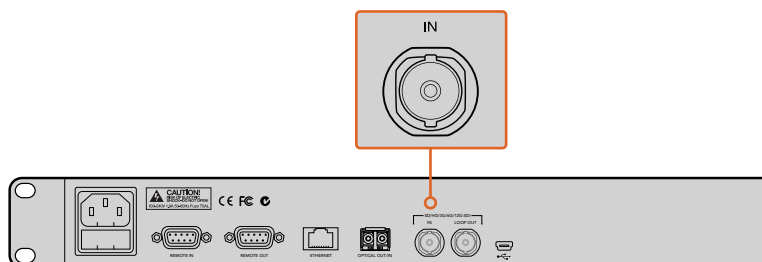

ソースビデオをSDI入力コネクタに接続。オーディオはSDIビデオ信号にエンベッドされます。

Blackmagic Duplicator 4Kは、2チャンネルのエンベッドSDIオーディオに対応しています。SDIビデオ入力から受信するため、オーディオを接続する必要はありません。

作業のコツ ソースビデオのオーディオレベルは、LCDのホームスクリーンで確認できます。

デージーチェーン

複数のBlackmagic Duplicator 4Kをデージーチェーン接続することで、より多くの数のSDカードへの収録が可能です。例えば、100枚のカードを複製したい場合は、4台のユニットをデージーチェーン接続して実行できます。

- 1 Blackmagic Duplicator 4KのRS-422「REMOTE OUT」を、次のユニットの「REMOTE IN」に接続します。デージーチェーンの各ユニットで同じ接続を繰り返します。
- 2 同様に、1台目のユニットのSDI出力「LOOP OUT」を、2台目のユニットのSDI入力「IN」に接続します。チェーンの各ユニットで同じ接続を繰り返します。
- 3 各ユニットのコントロールパネルには、「REM」ボタンがあります。これはリモートボタンです。複数のユニット間でのリモートコントロールを有効にするには、このボタンをオンにする必要があります。デージーチェーンの2台目から最後までBlackmagic Duplicator 4Kで、「REM」ボタンを押してください。

メモ デージーチェーン接続された他のすべてのユニットをコントロールするため、1台目のBlackmagic Duplicator 4Kの「REM」ボタンはオフにしてください。リモートをオフにした1台目のユニットは、マスターユニットです。マスターユニットのフロントパネルでボタンを押すと、その信号はリモート出力されます。これにより、「REM」ボタンがオンになっているデージーチェーン上の他のユニットがコントロールされます。リモートコントロールのプロトコルは業界標準のデッキコントロール・フォーマットであるため、RS-422デッキコントロールに対応したあらゆるテレビ製品をマスターユニットとして使用できます。

これで、デージーチェーン接続されたすべてのBlackmagic Duplicator 4Kが、1台目のユニットからのコマンドに従います。

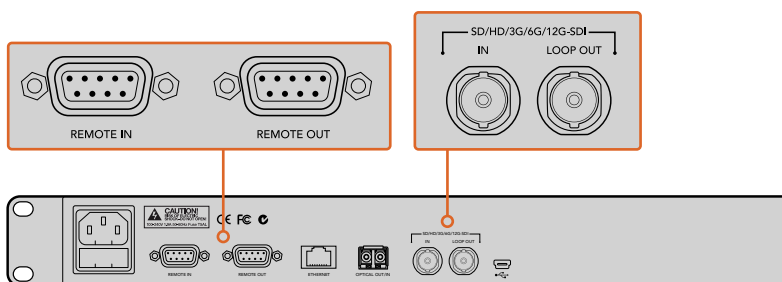

「REMOTE」および「LOOP」コネクタは、複数のBlackmagic Duplicator 4Kをデージーチェーン接続する場合に使用します。デージーチェーンの最後のユニットの「LOOP」コネクタからは、ソースビデオを他のSDI機器（Blackmagic SmartViewモニター、HyperDeckディスクレコーダーなど）にループ出力することも可能です。

複数ユニットのデージーチェーン接続に関する詳細は、「複数のユニットをデージーチェーン接続」セクションを参照してください。

SDカードの挿入/フォーマット

Blackmagic Duplicator 4Kは、一般的なクラス10のSDカードを使用します。最高速カードを購入する必要はありません。SDカードは、カメラ機器を販売している小売店で購入できます。クラス10のSDカードは、多くのスーパーマーケットでも取り扱われています。

作業のこつ SDカードのラベルには、小さな丸の中に1から10の数字がプリントされています。この数字はカードのスピードレートを示しており、10が最も速いレートです。丸の中に10という数字がプリントしてあるカードは、すべて“クラス10”のSDカードです。これらのカードで、Ultra HDビデオを最高ビットレート設定で収録できます。

SDカードを挿入する:

- 1 金のコネクタがコントロールパネルのLCDの方を向くようにSDカードを持ち、Blackmagic Duplicator 4KのSDカードスロットと直線になるように並べます。
- 2 カードがしっかりと固定されるまで、スロットにゆっくりと差し込みます。Blackmagic Duplicator 4Kはすばやくカードを確認し、カードの収録準備が整うと、スロットの上のステータスLEDが緑に点灯します。

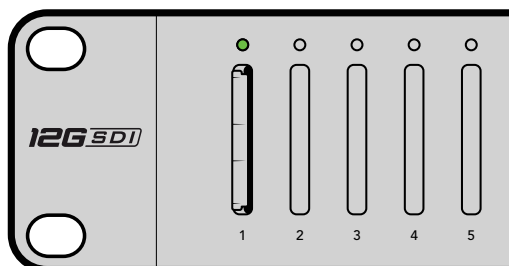
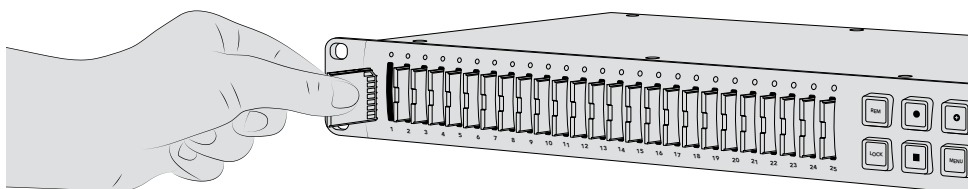

金のコネクタがLCDの方を向くようにSDカードを持ち、しっかりと固定されるまでゆっくりとスロットに差し込みます。カードの収録準備が整うと、LEDが緑に点灯します。

カードを取り出すには、カードの端を持ち、スロットから抜きます。

作業のこつ カードを挿入する際は、カードが書き込み保護されていないことを確認してください。書き込み保護を無効にするには、カードの左側にある小さなプラスチックのスイッチをコネクタの方向に動かします。収録が終わったら、スイッチをスライドして下に戻すことで、カードの書き込み保護を有効にできます。

SDカードのフォーマット

収録を開始する前に、SDカードをexFATにフォーマットする必要があります。このフォーマットは、macOS/Wondowsコンピューターの両方で使用できます。Blackmagic Duplicator 4Kのフォーマット機能では、使用するメディアを簡単にフォーマットできるだけでなく、1台のユニットで25枚までのSDカードを同時にフォーマットできます。

Blackmagic Duplicator 4KでSDカードをフォーマットする：

- 1 コントロールパネルの「MENU」ボタンを押します。
- 2 LCDの両側にある点灯したソフトボタンを使用して、収録ボタンを押します。
- 3 左矢印ソフトボタンを押して「Format Cards」設定を選択し、LCDメニューの右下にある「Format」を押します。
- 4 選択したフォーマットを確認するメッセージが表示されます。フォーマットを確定するには「Format」ソフトボタンを、中止するには「Cancel」を押します。
- 5 フォーマットの進行状況がプログレスバーに表示されます。フォーマットが完了したら「OK」を押します。
- 6 コントロールパネルの「MENU」ボタンを押すと、ホームスクリーンに戻ります。

コントロールパネルの「MENU」ボタンを押すと、ホームスクリーンに戻ります。

収録を始めるのに必要な作業はこれだけです。ビデオとオーディオが接続され、SDカードがフォーマットされました。収録を開始できます！

作業のこつ SDカードの種類やサイズに応じて、フォーマットにかかる時間は異なります。カードによっては、他のカードよりもフォーマットが早く完了します。

収録

収録は、コントロールパネルの収録ボタンを押すだけですぐに開始できますが、収録のタイプ、長さ、品質を決めるモード、コーデック、ビットレートを最初に設定することを推奨します。

収録モードの設定

Blackmagic Duplicator 4Kには以下のモードがあります：

- **Duplicate (複製)**：すべてのSDカードに同時書き込み
- **Single Disk (単一ディスク)**：1枚のSDカードに順番に書き込み、最後のカードがフルになった時点で収録を停止。
- **Single Disk Overwrite (単一ディスク上書き)**：1枚のSDカードに順番に書き込み、継続的なループで上書き。

Duplicate(複製)モード

Duplicateモードでは、Blackmagic Duplicator 4Kは同一のビデオをすべてのSDカードに同時に収録します。

Single Disk(単一ディスク)モード

Blackmagic Duplicator 4Kはロギング収録に最適で、テレビ放送から防犯カメラまで数多くの使用方法に対応します。1度に1つのSDスロットに書き込みを行い、SDカードがフルになったら、次の使用可能なスロットに収録を続けます。Single Diskモードでの収録では、Blackmagic Duplicator 4KはすべてのSDカードがフルになると収録を停止します。収録用のスロットが25個搭載されているため、1週間は容易に収録できます。中断なしで継続した収録が必要な場合、いつでもフルのカードを新しいカードに取り替えられます。

複数のDuplicatorをデジチェーン接続すれば、さらに長時間の収録が可能です。マスターユニットですべてのカードがフルになり次第、最初のスレーブユニットで収録が継続され、チェーンに接続されているすべてのユニットを通して順に収録が継続されます。収録は、最後のユニットの最後のカードがフルになった時点で停止します。

Single Disk Overwrite(単一ディスク上書き)モード

Single Disk Overwriteモードは、2枚以上のSDカードを挿入した単一のDuplicator 4Kで収録を行う際に、最後のカードがフルになると、最初のカードにループして戻るので継続した収録が可能です。書き込みは、1つのSDスロットずつ行われます。1枚のSDカードがフルになると、次の使用可能なSDカードをフォーマットし、収録を継続します。

このモードは、Single Diskモードに似ていますが、最後のカードがフルになると収録が停止する代わりに、単一のユニットが次のカードをループでフォーマットし、書き込みを行います。Single Disk Overwriteモードでは、停止ボタンを押すまでBlackmagic Duplicator 4Kは収録を継続します。

作業のこつ Single DiskモードまたはSingle Disk Overwriteモードで収録している場合、空き容量のある新しいカードをいつでも挿入できます。Duplicator 4Kは、25個のスロット内のいずれかのカードに空き容量がある限り、収録を続けます。

収録モードを設定する:

- 1 Blackmagic Duplicator 4Kの電源を入れます。
- 2 フロントコントロールパネルの「MENU」ボタンを押してLCDメニューを開きます。画面の隣のソフトボタンが点灯し、メニューのオプションを示します。収録ソフトボタンを押します。
「Record」メニューでは、画面の下に点が表示され、使用できるオプションの数を示します。メニューの上の階層には「Back」ボタンを押すと戻れます。オプションの切り替えには「<」および「>」ボタンを使用します。
- 3 「Mode」オプションまで進み、「Change」をクリックします。
- 4 「Select」ボタンを押して、現在表示されているモードを使用します。LCDメニューには、選択したオプションが表示されます。
- 5 「Back」ボタンを押して「Record」メニューに戻ります。選択したオプションが表示されます。

複数ユニットのデジチェーン接続に関しては、「複数のDuplicatorをデジチェーン接続」セクションを参照してください。

作業のこつ Single DiskモードまたはSingle Disk Overwriteモードで重要なイベントを収録しており、現在のカードがフルになる前にSDカードを取り出したい場合、収録ボタンを3秒間長押しすると次のSDカードに収録を切り替えられます。Duplicateモードで収録中は、アペンド収録ボタンを押します。詳細は「アペンド収録」セクションを参照してください。

コーデックの設定

Blackmagic Duplicator 4KはH.264またはH.265圧縮コーデックを使った収録が可能です。デフォルトでは、H.264圧縮を使用します。

コーデックの変更:

- 1 「MENU」ボタンを押します。
- 2 収録ソフトボタンを押して、収録設定を開きます。
- 3 矢印ソフトボタンを使用して「Codec」を選択し、「Change」を押します。
- 4 矢印ソフトボタンを使用してコーデックを選択し、「Set」を押して変更を確定します。またはコントロールパネルの「MENU」ボタンを押して、変更を確定し、LCDホームスクリーンに戻ります。

メモ コーデックの変更を行うには、Blackmagic Duplicator 4Kのソフトウェアがバージョン1.1以降にアップデートされている必要があります。ソフトウェアのアップデートに関する詳細は、「Blackmagic Duplicator Utility」のセクションを参照してください。

適切なコーデックの選択

最も幅広い互換性を得るにはH.264コーデックの使用を推奨します。Blackmagic Duplicator 4KのデフォルトのコーデックがH.264になっているのはそういった理由からです。

H.265は高品質のUltra HDを小さなファイルサイズに圧縮するのに適したコーデックですが、まだ新しいのでコンピューターや再生機器との互換性の幅はH.264と比較して低いことがあります。

いずれのコーデックも、それぞれ利点があります。H.265は低ビットレートでファイルサイズあたりの画質が優れているので、廉価なSDカードを使用できます。H.264は互換性が最重要事項である場合に適したコーデックです。

ビットレートの設定

Blackmagic Duplicator 4Kでは、「Low」、「Medium」、「High」の3つのビットレートから選択できます。これらの設定により、内蔵H.265エンコーダーがビデオ1秒あたりに書き込むデータの量を指定できます。ビットレートのデフォルト設定は「Medium」で、高品質かつ管理しやすいサイズのファイルが作成されます。この設定はLCDメニューで簡単に変更できます。

ビットレート設定を変更する:

- 1 「MENU」ボタンを押します。
- 2 収録ソフトボタンを押して、収録設定を開きます。
- 3 矢印ソフトボタンを使用して「Bit Rate」を選択し、「Change」を押します。
- 4 矢印ソフトボタンを使用してビットレートを選択し、「Set」を押して変更を確定します。またはコントロールパネルの「MENU」ボタンを押して、変更を確定し、LCDホームスクリーンに戻ります。

メモ 高いビットレートは高品質の収録を提供しますが、カード容量を多く使用します。サイズの大きい、高価なカードが必要となる場合もあります。一方データレートを下げると、カードに収録できる時間は長くなりますが、イメージ品質が下がりすぎてしまう場合があります。

最小限のファイルサイズで必要なイメージ品質が得られる設定を見つけるために、異なるビットレートで実験的な収録を行うことをお勧めします。

クリップの収録

収録を開始するには、コントロールパネルの収録ボタンを押してください。収録中は、各スロットのLEDステータスインジケーターが赤く点灯します。収録が停止すると、LEDインジケーターは緑に点灯します。これは、収録が問題なく行われ、次のクリップの収録が可能であることを示しています。収録した内容は、コンピューターのSDカードスロットまたはSDカードリーダーを通して簡単に確認できます。また、SDカードおよびexFATファイルシステムをサポートしているHDMIテレビでも確認できます。

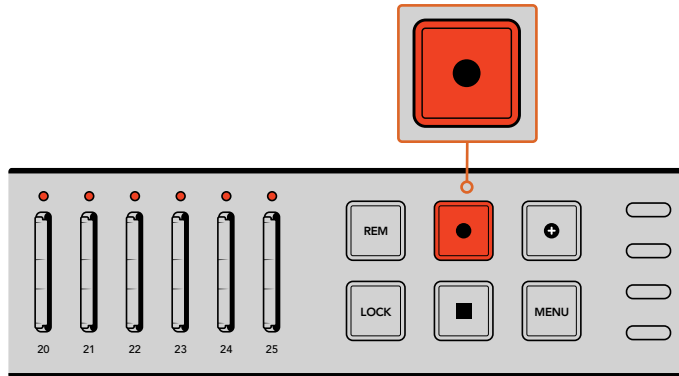

収録ボタンを押すと収録が開始されます。各スロットの上にあるステータスLEDが赤く光り、SDカードに収録中であることが確認できます。

LEDステータスインジケーター

各SDカードスロットの上にあるステータスLEDは、異なるカラーで点灯することでスロットの状況を示します。例えば、SDカードを挿入し、カードが認識されて収録の準備が整うと、スロットのLEDは緑に点灯します。

LEDのカラー、LEDの動作、それらの意味する状況：



緑の点灯

録画の準備ができています。SDカードの収録準備が整うとLEDは緑に光ります。



赤の連続した点灯

録画中です。クリップの収録中はLEDが赤く光ります。



赤の点滅

録画中で、カードがフルに近い状態です。カードに収録できる残り時間が3分を切ると、インジケーターが点滅します。



赤(すばやく点滅)

コマ落ちが発生しています。SDカードの書き込み速度が十分でなく、収録速度に追いついていません。



黄色の点灯

カードの残り容量なし、書き込み禁止、書き込みエラー。LEDが黄色に点灯している場合は、カードの状態が悪いか、書き込み禁止がかかっているか、フォーマットされていないか、残り容量が10秒未満であることを意味しています。これに対処するには、以下の方法があります。スイッチを切り替えてロックを解除する、データレートを下げる、高速のSDカードを使用する、カードをフォーマットする、別のカードと交換するなどです。

Blackmagic Duplicator 4Kは、収録中にカードが取り外された場合でも各カードのファイルシステムの構成・状態を保つよう試みますが、収録中にSDカードを取り外さないことは重要です。これは、カードを確認するオペレーティングシステムによっては他と比べて安定性の低いものもあり、収録した映像が破損しているように見える場合があるためです。したがって、カードの取り外しは常に収録を停止してから行ってください。撮影しているパフォーマンスが終わる前にカードを配布する場合は、複数のBlackmagic Duplicator 4Kを使用し、1つのユニットの収録を停止してカードを配布し、他のユニットで収録を続ける方法をお勧めします。

作業のこつ クラス10の SDカードではBlackmagic Duplicator 4Kでサポートされているすべてのデータレートでの収録が可能ですが、必要に応じて速度の低いカードを使用し、低データレートの収録を行うこともできます。例えば、長時間にわたるセキュリティビデオを収録する場合などは、最高品質のイメージは必要ありません。使用するSDカードが選択ビットレートでの収録に対応していることを確認するために、常にテスト収録を行うことをお勧めします。SDカードのスピードレートに関する詳細は、「はじめに」セクションの「SDカードの挿入/フォーマット」を参照してください。

アペンド収録

Duplicateモードで収録中に、新しいクリップを収録し、事前に収録したクリップに追加して1つのクリップにしたい場合があります。例えば、複数のイベントをまたいでパフォーマンスを収録するケースなどがあります。各イベントを個別に撮影し、それらの映像をすべてまとめて1つのクリップとして収録したい場合は、アペンド収録機能が役に立ちます。

- 1 通常通り収録ボタンを押して、1目のクリップを収録します。停止を押します。
- 2 次のイベントが始まったら、アペンド収録ボタンを押します。アペンド収録ボタンと収録ボタンが一緒に光り、事前に収録されたクリップの後に追加されるクリップが収録中であることが確認できます。
- 3 停止を押します。収録した新しいクリップが1目のクリップの後に追加され、1つのクリップとして保存されます。

作業のこつ アペンド収録機能では、1目のクリップの後に無制限の数のクリップを順番に追加できます。唯一注意することは、カードの容量と収録の長さだけです。

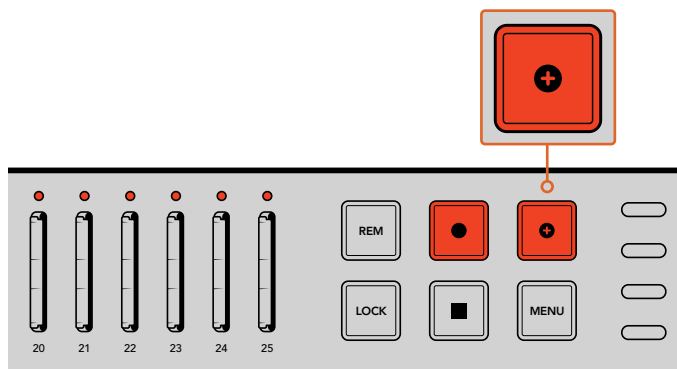

アペンド収録ボタンを押して、新しいクリップを事前に収録されたクリップの後に追加。

作業のこつ Single DiskモードまたはSingle Disk Overwriteモードで収録している場合、収録ボタンを3秒間長押しして、次のカードに収録を移行させ、現在のカードを取り出せます。これは、重要なイベントを撮影した直後に収録を止めずに、コンテンツを使用したい場合に便利です。Single DiskモードまたはSingle Disk Overwriteモードに関しては「収録モードの設定」セクションを参照してください。Duplicateモードで収録中は、アペンド収録ボタンを押します。詳細は「アペンド収録」セクションを参照してください

Blackmagic Duplicator 4Kのロック

必要なイベントを収録する際に、誤操作により収録が中断してしまわないよう、コントロールパネルをロックしたい場合があります。また、ダイジェーチェーンで繋いだスレーブユニットが誤って収録を中断しないよう、これらのユニットのコントロールをロックできることは非常に便利です。

「LOCK」ボタンを使えば、各ユニットのロック機能を独立して有効化/無効化できます。コントロールのロックを解除するには「LOCK」ボタンを2秒間長押しする必要があるため、ユニットのロックを誤って解除してしまう可能性はほぼありません。

Blackmagic Duplicator 4Kをロックする：

- 1 Blackmagic Duplicator 4Kのコントロールパネルにある「LOCK」ボタンを押します。
- 2 ユニットのロックを解除するには、「LOCK」ボタンを長押しします。2秒間長押しすると、ユニットのロックは解除されます。

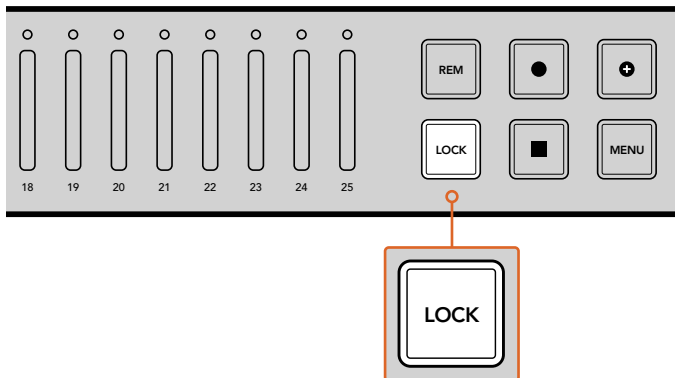

Blackmagic Duplicator 4Kのコントロールパネルをロックすることで、誤作動による収録の中断を防ぎます。

複数のユニットをダイジェーチェーン接続

25枚以上のSDカードに収録したい場合、複数のBlackmagic Duplicator 4Kをダイジェーチェーン接続できます。ダイジェーチェーンで接続すると、同じビデオ信号を各ユニットから「LOOP」SDIコネクタで共有でき、さらに「REMOTE」コネクタ経由でRS-422プロトコルを使用してユニット間の通信が可能です。

複数のBlackmagic Duplicator 4Kをデジチェーン接続する:

- 1 DB-9コネクターの一般的なシリアルケーブルを使用して、最初のユニットのRS-422「REMOTE OUT」ポートを、次のユニットの「REMOTE IN」ポートに接続します。DB-9コネクターのシリアルケーブルは、お近くのコンピューターショップや、ビデオ機材専門店などで一般的に入手可能です。
- 2 最初のユニットの「LOOP」SDI出力を2つめのユニットのSDI入力に接続します。

これだけで準備は完了です！より多くのBlackmagic Duplicator 4Kを接続したい場合は、「REMOTE/LOOP」出力を次のユニットの「REMOTE/LOOP」入力に接続していきます。

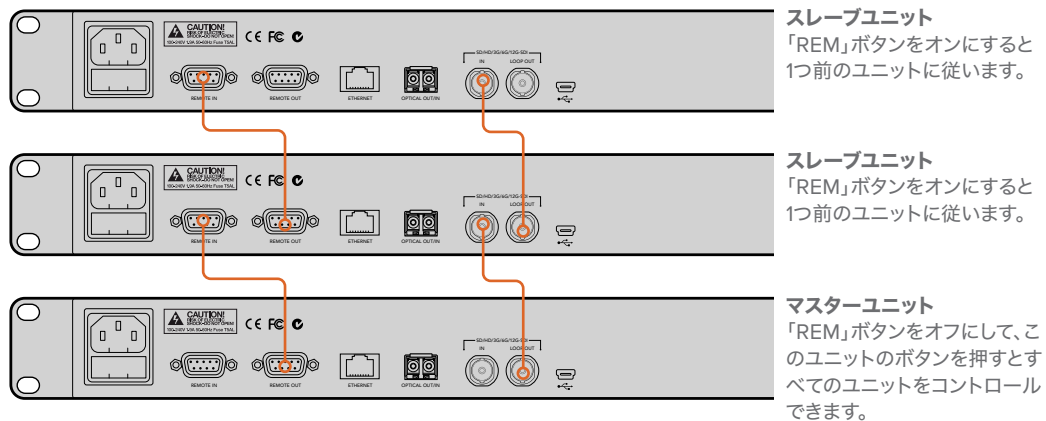

複数のBlackmagic Duplicator 4Kをデジチェーン接続するには、1台目のSDIループ出力を次のユニットのSDI入力に接続します。同様に、1台目の「REMOTE」出力を次のユニットの「REMOTE」入力に接続します。

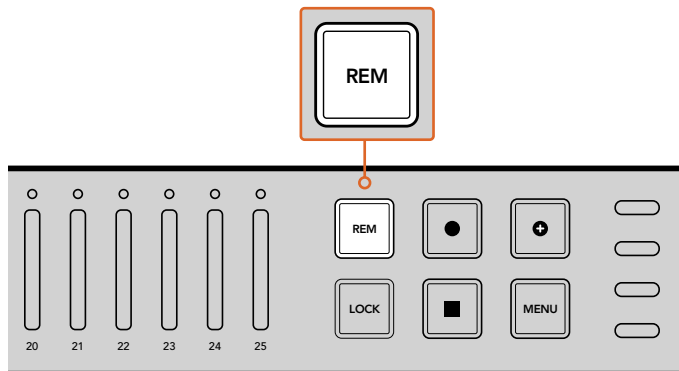

チェーンで繋がれた各スレーブユニットの「REM」ボタンを押すと、1台目のユニットからリモートコントロールが可能になります。

メモ すべてのスレーブユニットのコントロールパネルで「REM」ボタンを押してリモートコントロールを有効にしてください。「REM」ボタンは有効になると点灯します。もう一度押すと無効になります。

マスターユニットからすべてのユニットをコントロールできることを確認するため、本収録の前にテスト収録を行うと良いでしょう。スレーブユニットがマスターユニットに従っていない場合、マスターユニットの「REM」ボタンがオフになっており、スレーブユニットの「REM」ボタンがオンになっていることを確認してください。

LCDメニュー設定

Blackmagic Duplicator 4Kのすべての設定は、コントロールパネルのLCDメニューとソフトボタンを使って変更できます。ソフトボタンはLCDの両サイドに配置されており、LCDメニューに表示された設定に対応して点灯します。

設定の変更:

- 1 コントロールパネルの「MENU」ボタンを押してLCDメニュー設定を開きます。
- 2 メニューのソフトボタンを使ってメニューをナビゲートします。
- 3 設定を選択したら、「Change」メニューのソフトボタンを押します。
- 4 設定を調整し、「Set」を押して変更を確定します。

「Back」メニューソフトボタンを押せば、メニューシーケンスの1つ前に戻るので、いつでも変更をキャンセルできます。あるいはコントロールパネルの「MENU」ボタンを押してもLCDがホームスクリーンに戻ります。

収録(Record)

「Record」設定では、ビデオソースの変更、ビットレートの設定、トリガー収録の有効化/無効化、SDIカードのフォーマットが可能です。

ビデオソース(Video source)

同設定は、Optical Fiber SDI Moduleをインストールしている場合、SDI入力/光ファイバー入力の選択に使用します。

モード

この設定を使用して収録モードを選択します:

Duplicate(複製)

同じビデオを同時にすべてのSDカードに収録します。

Single Disk(単一ディスク)

1度に1枚のSDカードに書き込みを行い、そのSDカードがフルになったら、次の使用可能なSDカードに収録を継続します。すべてのカードがフルになると、Duplicator 4Kは収録を停止します。複数のユニットをデジチェーン接続している場合、収録は次のDuplicator 4Kで継続され、すべてのSDカードがフルになった時点で停止します。

Single Disk Overwrite(単一ディスク上書き)

継続的なループで収録します。1度に1枚のSDカードに書き込みを行い、そのSDカードがフルになったら、次の使用可能なSDカードに収録を継続します。すべてのカードがフルになると、Duplicator 4Kは最初のSDカードにループして戻り、収録を続けます。

コーデック(Codec)

Blackmagic Duplicator 4Kでの収録に使用するコーデックをH.264またはH.265圧縮コーデックから選択します。

各コーデックの詳細は下記を参照してください。

H.264

非常に広く使用されている圧縮コーデックで、画質とファイルサイズのバランスが優れています。過去10年間に作られた再生機器は、少なくともHD解像度までのH.264で圧縮されたファイルを再生できます。

H.265

極めて優れた圧縮率のコーデックで、H.264と比較して同じビデオファイルのサイズの画質が優れています。H.265は高画質やUltra HDの圧縮に向いていますが、再生にはより新しいソフトウェアやハードウェアが必要なことがあります。

メモ H.264とH.265の違いに関する詳細は、このマニュアルの「収録」セクションを参照してください。

ビットレート(Bit Rate)

ビットレート設定は、SDカードに収録するビデオの容量と品質を決定します。以下の3つのオプションから選択できます。

High

最小限の圧縮率で、最高品質のビデオを得たい場合のオプション。

Medium

高画質のイメージで、SDカードにより多くのビデオを収録したい場合のオプション。

Low

高画質は必要ないけれども、SDカードに可能な限り多くのビデオを収録したい場合のオプション。この設定は、イメージを最大限に圧縮するため、目に見える圧縮アーチフェクトが生じる場合があります。

メモ 内蔵H.265エンコーダーは、最新の圧縮テクノロジーを使用します。つまり、最小限のデータ量で、最高画質のビデオを収録できます。設定を「Low」にしても、ほとんどのビデオ圧縮で良好な品質の収録が可能です。

ビデオフォーマットのビットレート

Ultra HD			
ビデオフォーマット	ビットレート設定	ビットレート(Mb/s) H.264	ビットレート(Mb/s) H.265
2160p60	High	75	50
	Medium	66	38
	Low	50	20
2160p59.94	High	75	50
	Medium	66	38
	Low	50	20

Ultra HD			
ビデオフォーマット	ビットレート設定	ビットレート (Mb/s) H.264	ビットレート (Mb/s) H.265
2160p50	High	72	48
	Medium	61	32
	Low	42	16
2160p30	High	50	30
	Medium	37	20
	Low	24	10
2160p29.97	High	50	30
	Medium	37	20
	Low	24	10
2160p25	High	40	25
	Medium	32	18
	Low	20	10
2160p24	High	40	25
	Medium	32	18
	Low	20	10
2160p23.98	High	40	25
	Medium	32	18
	Low	20	10

HD			
ビデオフォーマット	ビットレート設定	ビットレート (Mb/s) H.264	ビットレート (Mb/s) H.265
1080p60	High	40	20
	Medium	32	15
	Low	20	10
1080i60	High	40	20
	Medium	32	15
	Low	20	10
1080p59.94	High	40	20
	Medium	32	15
	Low	20	10
1080i59.94	High	40	20
	Medium	32	15
	Low	20	10
1080p50	High	36	20
	Medium	28	15
	Low	18	10

HD			
ビデオフォーマット	ビットレート設定	ビットレート (Mb/s) H.264	ビットレート (Mb/s) H.265
1080i50	High	36	20
	Medium	28	15
	Low	18	10
1080p30	High	28	15
	Medium	20	11
	Low	11	7
1080p29.97	High	28	15
	Medium	20	11
	Low	11	7
1080p25	High	24	15
	Medium	16	10
	Low	9	6
1080p24	High	24	15
	Medium	15	10
	Low	8	6
1080p23.98	High	24	15
	Medium	15	10
	Low	8	6
720p60	High	25	12
	Medium	17	10
	Low	9	8
720p59.94	High	25	12
	Medium	17	10
	Low	9	8
720p50	High	20	12
	Medium	14	9
	Low	7	6

SD			
ビデオフォーマット	ビットレート設定	ビットレート (Mb/s) H.264	ビットレート (Mb/s) H.265
625i50 PAL	High	18	11
	Medium	12	8
	Low	6	6
525i59.94 NTSC	High	20	12
	Medium	14	9
	Low	7	6

トリガー収録(Trigger)

トリガー設定は、トリガー収録機能を有効化します。これにより、Blackmagic URSA Miniなどの他のSDI機器の収録ボタンを使って、Blackmagic Duplicator 4Kの収録開始をトリガーできるようになります。

None

トリガー収録機能を無効化します。

SDI Start/Stop

このオプションを選択すると、Blackmagic Duplicator 4KはSDI機器の収録ボタンを押した際に収録を開始します。

例えば、Blackmagi URSA Miniは、SDI出力を介して常に収録トリガー信号を送信しています。このため、カメラで収録ボタンを押すと、Blackmagic Duplicator 4Kは収録を開始し、再度収録ボタンを押すと収録を停止します。URSA Miniでトリガー収録機能を有効にするために設定を調整する必要はありません。しかし、トリガー収録に対応しているその他の機器を使用したい場合は、その機器の設定メニューを使用して、SDI開始/停止トリガー収録を有効化する必要があります。

Timecode Run

使用しているSDI機器がSDI開始/停止トリガー収録に対応していない場合、Blackmagic Duplicator 4Kがタイムコードを検出したらすぐに収録を開始するよう設定できます。例えば、あるSDIカメラをBlackmagic Duplicator 4Kに接続しており、そのカメラが「Record Run」タイムコードに設定されていれば、Blackmagic Duplicator 4Kの収録開始をトリガーできます。カメラで収録を停止すると、タイムコードが止まるので、Blackmagic Duplicator 4Kでの収録も停止します。

これは非常に便利な機能ですが、使用する機器のタイムコード設定が「Record Run」になっていることを必ず確認してください。タイムコード設定が「時刻(Time of day)」に設定されている場合、継続的にタイムコードが出力され、Blackmagic Duplicator 4Kがトリガー収録され続けてしまうので気をつけてください。

カードのフォーマット(Format Cards)

Blackmagic Duplicator 4Kのフォーマット機能を使用すれば、最大25枚のカードを同時にフォーマットできます。

カードをフォーマットする:

- 1 コントロールパネルの「MENU」ボタンを押してLCDメニューを開きます。
- 2 収録メニューソフトボタンを押して収録設定を開きます。
- 3 左右の矢印ソフトボタンを押して、「Format Cards」設定へとナビゲートし、「Format」ボタンを押します。
- 4 カードのフォーマットを確認するメッセージが表示されます。また、この操作は取り消せないという警告も表示されます。SDカードに残しておきたいデータが入っている場合は、この操作を実行する前にデータをバックアップしてください。
- 5 「Format」を押して操作を確定します。「Cancel」を押して「Record」設定に戻ることもできます。
- 6 カードがフォーマットされている間、ステータスLEDインジケーターが黄色く点滅し、LCDにプログレスバーが表示されます。カードのフォーマットが完了したら、ステータスインジケーターが緑に光り、LCDメニューにフォーマットが完了し収録できる状態になったというアドバイスが表示されます。
- 7 「OK」を押します。コントロールパネルの「MENU」ボタンを押してホームスクリーンに戻ります。

設定 (Settings)

「Settings」メニューは、DHCPのオン/オフ、IPアドレス、サブネットマスク、ゲートウェイ設定など、Blackmagic Duplicator 4Kのネットワーク設定の変更に使用します。Blackmagic Duplicator 4Kをネットワークに接続すると、Telnetなどのサードパーティ製の管理ソフトを使ってユニットをリモートコントロールできます。

DHCP 「ON」

ネットワーク接続時に、Blackmagic Duplicator 4Kを自動的に最適な設定にするよう設定する場合は「ON」にします。つまり、Blackmagic Duplicator 4Kがネットワーク上のすべての接続デバイスを確認して、IPアドレスを設定し、設定上の問題が生じないように、その他のネットワーク設定を確認します。これは非常に信頼性の高い機能で、ネットワーク設定を簡単かつ迅速に構築できます。

DHCP 「OFF」

ネットワーク設定をすべてマニュアルでコントロールしたい場合、DHCPを「OFF」にすると、IPアドレス、サブネットマスク、ゲートウェイ設定へ行き、マニュアルで入力できます。

IPアドレス、サブネットマスク、ゲートウェイ

DHCPが「OFF」になっている場合、これらの設定をマニュアルで変更できます。

数字フィールドの編集:

- 1 左右のソフトメニューボタンを使って変更したい数字フィールドを選択し、「Change」を押します。
- 2 左右のソフトメニューボタンを押して、数値を上げ下げします。ソフトボタンを長押しすると数値をスピーディに変更できます。
- 3 「Save」を押して変更を確定します。

ソフトメニューボタンを使い、その他のシーケンスに進んで必要な変更を実行します。



LCDの「Settings」メニューでネットワーク設定を変更できるので、Telnetなどのサードパーティ製の管理ソフトを使ってBlackmagic Duplicator 4Kをコントロールできます。

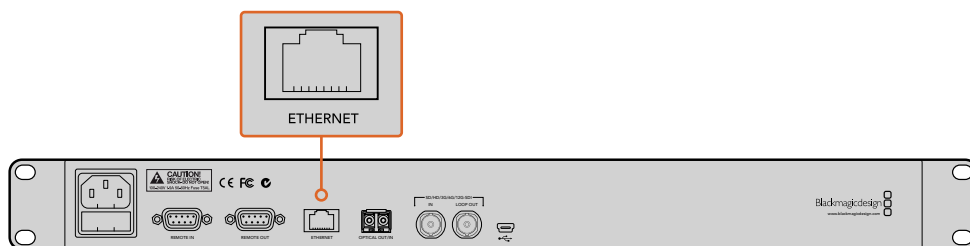

リアパネルのイーサネットポート経由でBlackmagic Duplicator 4Kをネットワークに接続してください。

ご使用のユニットについて (About)

同メニュー設定は、現在のビットレート、最後に収録したファイルの名前、ネットワーク状況、内部ソフトウェアのバージョンなど、ご使用のBlackmagic Duplicator 4Kの概要を表示します。

Blackmagic Duplicator Utility

Blackmagic Duplicator 4Kをアップデート

Blackmagic Duplicator Utilityソフトウェアは、Blackmagic Duplicator 4Kの内部ソフトウェアのアップデートや、各収録ファイルにラベルを付けられるファイル名プレフィックス設定の変更に使用します。このソフトウェアをダウンロードしてBlackmagic Duplicator 4Kをアップデートし、最新または改善された機能を使用することをお勧めします。

最新バージョンのソフトウェアは、Blackmagic Designサポートセンターからダウンロードできます。
www.blackmagicdesign.com/jp/support

macOSで内部ソフトウェアをアップデートする:

- 1 Blackmagic Duplicator Utilityをダウンロードして解凍します。
- 2 ディスクイメージを開いてBlackmagic Duplicator Utility Installerを起動します。スクリーン上の指示に従います。
- 3 最新のBlackmagic Duplicator Utilityをインストールしたら、USBケーブルでBlackmagic Duplicator 4Kとコンピューターを接続します。
- 4 Blackmagic Duplicator Utilityを起動し、丸い設定アイコンをクリックして設定画面を開きます。Blackmagic Duplicator 4Kに古いバージョンが検出された場合、「Update Now」アイコンが表示されます。表示されたアイコンをクリックして内部ソフトウェアをアップデートします。Blackmagic Duplicator 4Kに最新のソフトウェアがインストールされている場合は何もする必要はありません。

Windowsで内部ソフトウェアをアップデートする:

- 1 Blackmagic Duplicator Utilityをダウンロードして解凍します。
- 2 同マニュアルおよびBlackmagic Duplicator Utilityインストーラーを含むBlackmagic Duplicator Utilityフォルダーが確認できます。インストーラーをダブルクリックし、画面に表示される指示に従ってインストールします。
- 3 最新のBlackmagic Duplicator Utilityをインストールしたら、USBケーブルでBlackmagic Duplicator 4Kとコンピューターを接続します。
- 4 Blackmagic Duplicator Utilityを起動し、丸い設定アイコンをクリックして設定画面を開きます。Blackmagic Duplicator 4Kに古いバージョンが検出された場合、「Update Now」アイコンが表示されます。表示されたアイコンをクリックして内部ソフトウェアをアップデートします。Blackmagic Duplicator 4Kに最新のソフトウェアがインストールされている場合は何もする必要はありません。

ファイル名プレフィックス

ファイル名プレフィックスは変更が可能なので、各収録ファイルはラベルで簡単に識別できます。「File Name Prefix」編集ボックスをクリックして、新しい名前を入力します。これで、Blackmagic Duplicator 4Kで次のクリップを収録すると、ファイル名はカスタマイズした名前、クリップ番号識別用の4桁の数字で構成されます。これらの数字は収録クリップごとに増加します。

また、各スレーブユニットのリモートボタンをオンにしてからマスターユニットのファイル名プレフィックス設定を変更することで、デジチェーン接続したすべてのユニットの収録ファイルに確実に同じファイル名を使用できます。これにより、クリップを収録する際にすべてのユニットのすべてのカードのファイル名を統一できます。

オプションのOptical Fiber SDI Moduleをインストール

SDIビデオを光ファイバー経由で接続したい場合、オプションのOptical Fiber SDI Moduleをインストールします。SMPTE準拠のあらゆるSFP光ファイバーモジュールがインストール可能で、Blackmagic Design販売店でも購入できます。モジュールは、Blackmagic Duplicator 4Kのリアパネルに内蔵された光ファイバーケーブルに差し込みます。Optical Fiber SDI Moduleをインストールすると、エンベデッドオーディオのついたSDIビデオを非常に長いケーブルで送信できます。光出力を追加のループビデオコネクタとして使用することもできます。

3G-SDI/6G-SDI光ファイバーなど低速光ファイバーシステムを使用していて、それ以上のスピードが必要ない場合は、同スロットに低速のモジュールをインストールすることでコストを削減できます。

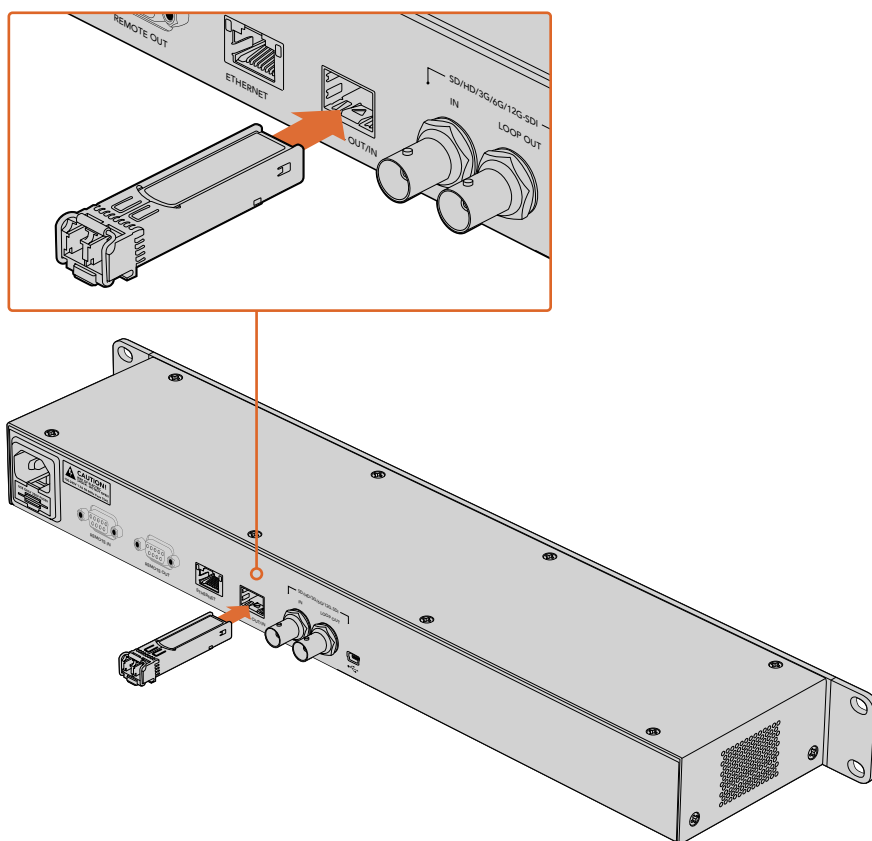

オプションのOptical Fiber SDI ModuleをインストールするとSDIビデオを光ファイバー経由で接続できます。

Blackmagic Duplicator 4Kは、最初に接続されたビデオコネクタを使用しますが、SDIと光ファイバーを両方接続している場合、LCDメニューの「Video Source」設定で選択することができます。詳細は、「設定」セクションを参照してください。

RS-422コントロール

RS-422とは？

RS-422スタンダードは、シリアルデッキコントロールの放送標準で、1980年代初頭から多くの放送局で採用されています。数多くのデッキ、リニアエディター、ノンリニアエディター、放送オートメーション製品などで使用されています。Blackmagic Duplicator 4Kは、このスタンダードをサポートしているので、放送オートメーション、リモートコントロールシステム、スケジュール収録システム、そして自由にデザインしたあらゆる種類のカスタムコントロールに組み込むことができます。

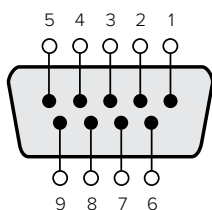

送信 (-)	送信 (+)	受信 (-)	受信 (+)	グランドピン
2	7	8	3	1, 4, 6, 9

リモート出力コネクタのRS-422リモートピン接続

外部RS-422コントローラーを使用する

Blackmagic Duplicator 4Kは、業界標準のSony™互換リモートRS-422デッキコントロールポートを搭載しており、RS-422対応リモートコントローラーに正しいピンで接続できます。

市販の9ピンケーブルを使用可能ですが、ケーブル両端の同じピン番号同士がそれぞれ接続されている必要があります。使用する機器の配線が異なり、カスタムケーブルを作成する場合は、付随のリモート出力配線図を参照し、Transmit (Tx) ピンがReceive (Rx) ピンに接続されることを確認してください。

外部RS-422コントローラーをBlackmagic Duplicator 4Kに接続することで、ユニットのボタンを押すことなく、ユニットをリモートコントロールできます。

- 1 外部コントローラーのRS-422ケーブルを、Blackmagic Duplicator 4Kのリモート入力 (REMOTE IN) に接続します。
- 2 Blackmagic Duplicator 4Kのコントロールパネルで「REM」と記されたリモートボタンを押し、リモートデッキコントロールを有効にします。

これで、Blackmagic Duplicator 4Kの収録およびアベンド収録の開始/停止をリモートコントロールできます。対応するRS-422コマンドのリストは、次ページの「Supported RS-422 Commands」セクションを参照してください。

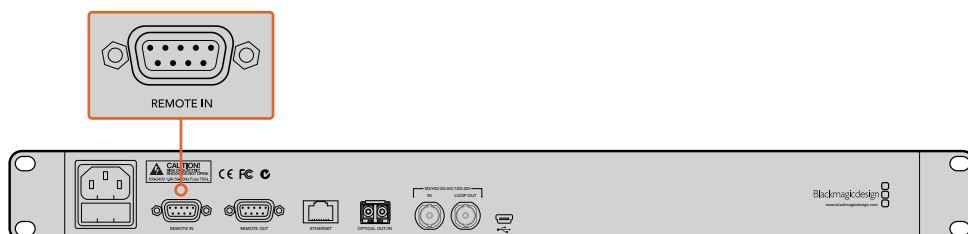

外部RS-422コントローラーをBlackmagic Duplicator 4Kの「REMOTE IN」に接続して、ユニットをリモートコントロールできます。

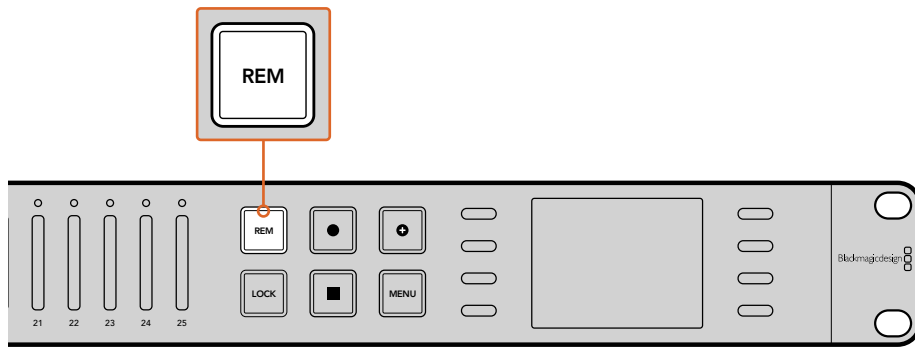

Blackmagic Duplicator 4Kのコントロールパネルで「REM」ボタンを押し、リモートデッキコントロールを有効にします。

Supported RS-422 Commands

		Command	Reply	No Remote	Notes
0 - System Control					
0x00	0x11	DeviceTypeRequest	NTSC: 0xF0E0 PAL: 0xF1E0 24P: 0xF2E0	Enabled	-
1 - Slave Response					
0x20	0x00	Stop	Acknowledge	Disabled	-
0x20	0x02	Record	Acknowledge	Disabled	-
0x21	0x02	Append	Acknowledge	Disabled	Non-standard command - an extra payload of 0x00 indicates append
4 - Preset/Select Control					
0x40	0x40	AutoMode Off	Acknowledge	Disabled	ignored, Status bit remembered
0x40	0x41	AutoMode On	Acknowledge	Disabled	ignored, Status bit remembered
0x61	0x20	StatusSense	StatusData	Enabled	-
7 - Sense Reply					
0x70	0x20	StatusData	-	-	Please see "Status Bits" sheet: Limited to 9 bytes of status, silently truncated

RS-422 Developer Information

	Bit 7	Bit 6	Bit 5	Bit 4	Bit 3	Bit 2	Bit 1	Bit 0
Byte 0	0	0	Cassette out	0	0	0	0	Local
Byte 1	Standby	0	Stop	0	0	0	Record	0
Byte 2	0	0	0	0	0	0	0	0
Byte 3	Auto Mode	0	0	0	0	0	0	0
Byte 4	Select EE	Full EE	0	0	0	0	0	0
Byte 5	0	0	0	0	0	0	0	0
Byte 6	0	0	0	0	0	0	0	0
Byte 7	0	0	0	0	0	0	0	0
Byte 8	0	0	0	0	0	0	0	0
Byte 9	0	0	0	0	0	0	0	0

Variables	
Cassette Out	Set if no cards are ready to record
Local	Set if in local mode (no remote control)
Standby	Set if one or more cards are ready to record
Auto Mode	For compatibility only
Full EE	For compatibility only - always on
Select EE	For compatibility only - always on

Blackmagic Duplicator 4K RS-422 Settings	
Protocol	Based on Sony 9-pin protocol
Baud Rate	38.4 K
Start Bits	1
Data Bits	8
Stop Bits	1
Parity Bits	1
Parity Type	Odd

イーサネット経由でリモートコントロール

Blackmagic Duplicator 4Kは、Blackmagic HyperDeck Ethernet Protocolのテキストベース・コマンドを使用して、イーサネット経由で外部からコントロールできます。HyperDeck Ethernet Protocolを使用することで、Telnetなどの管理ソフトウェアでBlackmagic Duplicator 4Kをコンピューターからリモートコントロールできるだけでなく、独自のハードウェアコントロールパネルをカスタムビルドしてプログラミングし、Blackmagic Duplicator 4Kと統合化できます。

様々なカスタムソリューションを開発して、コンピューターや専用のハードウェアコントロールデバイス、さらには放送局や中継器で使用される大型システムからBlackmagic Duplicator 4Kをコントロールできます。例えば、Arduinoマイクロコントローラーは小さなサーキットボードで、「シールド」と呼ばれる拡張ボードでカスタマイズできます。シールドには多くの種類があり、それぞれ様々なコネクタを搭載しています。Blackmagic Duplicator 4Kをコントロールするには、イーサネット対応シールドが必要です。プログラミング対応ボタンを搭載したシールドを追加することもできます！Arduinoマイクロコントローラーはセットアップが簡単で、価格も低く、完全なオープンソースです。Arduinoソフトウェアをプログラミングした後は、ArduinoをBlackmagic Duplicator 4Kのイーサネットポートに接続するだけで、ユニットのコントロールをすぐに開始できます。

Arduinoを使用したコントロールの例

Arduinoマイクロコントローラーのプログラミングには、一般的なC言語を使用します。コントローラーをプログラミングし、HyperDeck Ethernet Protocolを使用してBlackmagic Duplicator 4Kへのコマンドをトリガーできます。サポートされているすべてのコマンドは、次ページ以降の「Blackmagic HyperDeck Ethernet Protocol」セクションに記載されています。

Arduinoに他の拡張シールドを追加することで、様々な収録機能が使用できます。例えば、内部クロックを追加すれば、Blackmagic Duplicator 4Kに特定の時間に収録を開始させるようコントローラーをプログラミングできます。この機能はセキュリティ目的のビデオをスケジュール収録する際になどに便利です。

このテクノロジーは拡張性が高く、多くの使用方法が考えられます。外部イーサネットコントローラーをカスタムビルドした際には、その内容をぜひお聞かせください！



```
BlackmagicDuplicatorControl | Arduino 1.6.5

BlackmagicDuplicatorControl
/*
 * Telnet client Blackmagic Duplicator 4K Control
 *
 * Circuit:
 * Ethernet shield attached to pins 10, 11, 12, 13
 */
#include <SPI.h>
#include <Ethernet.h>

// Enter a MAC address and IP address for your controller below.
// The IP address will be dependent on your local network:

byte mac[] = {0x90, 0xA2, 0xDA, 0x0F, 0x17, 0xEF};
byte ip[] = {192, 168, 28, 204}; //IP address of Ethernet Shield
byte server[] = {192, 168, 28, 85}; //IP address of Duplicator

EthernetClient client; //Give the ethernet client a name

void setup()
{
  Ethernet.begin(mac, ip); //Start the Ethernet connection:
  client.connect(server, 9993); //Connect to Duplicator on port 9993
}

void loop()
{
  while (client.available()) //Read the Duplicator Preamble
  {
    char c = client.read();
  }

  client.print("record: name: CAMERA1\x0a"); //Start Duplicator recording a clip named Camera 1
  delay(60000); //Wait a minute
  client.print(">stop\x0a"); //Stop recoding
  while (1); //Do nothing until program starts again
}
```

Done Saving.

Sketch uses 9,710 bytes (30%) of program storage space. Maximum is 32,256 bytes.
Global variables use 236 bytes (11%) of dynamic memory, leaving 1,812 bytes for local variables. Maximum is 2,048 bytes.

36 Arduino/Genuino Uno on /dev/tty.usbmodem1421

Arduinoとイーサネットシールドを使用するこの例のように、外部イーサネットコントローラーをプログラミングする場合は、HyperDeck Ethernet Protocolリファレンスを使用して各コントロールに必要なコマンドを選択してください。

上のウィンドウのコードは次のページに記載されているので、Arduino IDEにコピー&ペーストできます。このコードでArduinoがBlackmagic Duplicator 4Kに対し送信するコマンドは、1分間収録し、収録を停止して、次にプログラムが開始するまで待つという内容です。

```
/*
   Telnet client Blackmagic Duplicator 4K Control Circuit: *
Ethernet shield attached to pins 10, 11, 12, 13
*/
#include <SPI.h>
#include <Ethernet.h>
// Enter a MAC address and IP address for your controller below.
// The IP address will be dependent on your local network:
byte mac[] = {0x90, 0xA2, 0xDA, 0x0F, 0x17, 0xEF};
byte ip[] = {192, 168, 28, 204};           // IP address of Ethernet
Shield
byte server[] = {192, 168, 28, 141};      // IP address of Duplicator
EthernetClient client;                   // Give the ethernet client a
name

void setup()
{
  Ethernet.begin(mac, ip);    //Start the Ethernet connection:

  client.connect(server, 9993); //Connect to Duplicator on port 9993
}
void loop()
{
  while (client.available()) //Read the Duplicator Preamble
  {
    char c = client.read();
  }
  client.print("record: name: Camera1\x0a");
  //Start Duplicator recording a clip named Camera 1
  delay(60000); //Wait a minute
  client.print("stop\x0a"); //Stop recoding
  while (1); //Do nothing until program starts
again
}
```

Blackmagic HyperDeck Ethernet Protocol

Blackmagic HyperDeck Ethernet Protocolは、テキストベースのプロトコルです。もともとはBlackmagic HyperDeckディスクレコーダーをイーサネットポート経由でコントロールするために開発されたものですが、Blackmagic Duplicator 4Kのコントロールにも使用できます。

Blackmagic Duplicator 4Kは収録のみを実行するため、HyperDeck Ethernet Protocolのすべてのコマンドは必要ありません。従ってこのセクションでは、HyperDeck Ethernet ProtocolをBlackmagic Duplicator 4Kで使用する際に関連のあるコマンドを表記しています。

Protocol Commands

Command	Command Description
help or ?	Provides help text with all commands and parameters.
remote	Queries the state of HyperDeck's remote control mode.
remote: enable: true	Enables remote control.
remote: enable: false	Disables remote control.
remote: override: true	Turns remote override on.
remote: override: false	Turns remote override off.
quit	Disconnects HyperDeck server.
ping	Determines HyperDeck server is responding.
record	Starts recording.
record: append: true	Starts appended recording.
stop	Stops playback or recording.
commands	Lists all supported commands in an XML format.
notify	Queries the current state of all notifications.
notify: transport: true	Enables transport notifications.
notify: transport: false	Disables transport notifications.
notify: slot: true	Enables slot notifications.
notify: slot: false	Disables slot notifications.
notify: remote: true	Enables remote notifications.
notify: remote: false	Disables remote notifications.
notify: configuration: true	Enables configuration notifications.
notify: configuration: false	Disables configuration notifications.
notify: dropped frames: true	Enables dropped frames notifications.
notify: dropped frames: false	Disables dropped frames notifications.
device info	Provides device information.
slot info: slot id: {slot ID}	Provides information about a specified slot.
transport info	Provides information for the state of the transport.
configuration	Queries the current configuration.
configuration: record mode: Duplicate	Configures the record mode to duplicate.

Command	Command Description
configuration: record mode: SingleDisk	Configures the record mode to single disk.
configuration: record mode: DiskOverwrite	Configures the record mode to disk overwrite.
configuration: video input: {"SDI", "optical"}	Configures video input.
configuration: file format: {format}	Configures the record codec and bit rate.
format: prepare: {format}	prepare a disk formatting operation to filesystem {format}
format: confirm: {token}	perform a pre-prepared formatting operation using token
watchdog: period: {seconds}	Configures the watchdog.

Using XML

While you can use the Terminal to talk to HyperDeck, if you are writing software you can use XML to confirm the existence of a specific command based on the firmware of the HyperDeck you are communicating with. This helps your software user interface adjust to the capabilities of the specific HyperDeck model and software version.

Protocol Details

Connection

The HyperDeck Ethernet server listens on TCP port 9993.

Basic syntax

The HyperDeck protocol is a line oriented text protocol. Lines from the server will be separated by an ascii CR LF sequence. Messages from the client may be separated by LF or CR LF.

New lines are represented in this document as a "↵" symbol.

Command syntax

Command parameters are usually optional. A command with no parameters is terminated with a new line:

```
{Command name}↵
```

If parameters are specified, the command name is followed by a colon, then pairs of parameter names and values. Each parameter name is terminated with a colon character:

```
{Command name}: {Parameter}: {Value} {Parameter}: {Value} ...↵
```

Response syntax

Simple responses from the server consist of a three digit response code and descriptive text terminated by a new line:

```
{Response code} {Response text}↵
```

If a response carries parameters, the response text is terminated with a colon, and parameter name and value pairs follow on subsequent lines until a blank line is returned:

```
{Response code} {Response text}:↵
{Parameter}: {Value}↵
{Parameter}: {Value}↵
...
↵
```

Successful response codes

A simple acknowledgement of a command is indicated with a response code of 200:

```
200 ok↵
```

Other successful responses carry parameters and are indicated with response codes in the range of 201 to 299.

Failure response codes

Failure responses to commands are indicated with response codes in the range of 100 to 199:

```
100 syntax error
101 unsupported parameter
102 invalid value
103 unsupported
104 disk full
105 no disk
106 disk error
109 out of range
110 no input
111 remote control disabled
120 connection rejected
150 invalid state
```

Asynchronous response codes

The server may return asynchronous messages at any time. These responses are indicated with response codes in the range of 500 to 599:

```
5xx {Response Text}:↵
{Parameter}: {Value}↵
{Parameter}: {Value}↵
↵
```

Connection response

On connection, an asynchronous message will be delivered:

```
500 connection info:↵
protocol version: {Version}↵
model: {Model Name}↵
↵
```

Connection rejection

Only one client may connect to the server at a time. If other clients attempt to connect concurrently, they will receive an error and be disconnected:

```
120 connection rejected↵
```

Timecode syntax

Timecodes are expressed as non-drop-frame timecode in the format:

```
HH:MM:SS:FF
```

Handling of deck "remote" state

The "remote" command may be used to enable or disable the remote control of the deck. Any attempt to change the deck state over ethernet while remote access is disabled will generate an error:

```
111 remote control disabled↵
```

To enable or disable remote control:

```
remote: enable: {"true", "false"} ↵
```

The current remote control state may be overridden allowing remote access over ethernet irrespective of the current remote control state:

```
remote: override: {"true", "false"} ↵
```

The override state is only valid for the currently connected ethernet client and only while the connection remains open.

The "remote" command may be used to query the remote control state of the deck by specifying no parameters:

```
remote↵
```

The deck will return the current remote control state:

```
210 remote info:↵
enabled: {"true", "false"}↵
override: {"true", "false"}↵
↵
```

Asynchronous remote control information change notification is disabled by default and may be configured with the "notify" command. When enabled, changes in remote state will generate a "510 remote info:" asynchronous message with the same parameters as the "210 remote info:" message.

Closing connection

The "quit" command instructs the server to cleanly shut down the connection:

```
quit↵
```

Checking connection status

The "ping" command has no function other than to determine if the server is responding:

```
ping↵
```

Getting help

The "help" or "?" commands return human readable help text describing all available commands and parameters:

```
help↵
```

or:

```
?↵
```

The server will respond with a list of all supported commands:

```
201 help:↵
{Help Text}↵
{Help Text}↵
↵
```

Stopping deck operation

The "stop" command instructs the deck to stop the current capture:

```
stop↵
```

Enumerating supported commands and parameters

The "commands" command returns the supported commands:

```
commands↵
```

The command list is returned in a computer readable XML format:

```
212 commands:
<commands>↵
    <command name="..."><parameter name="..." />...</command>↵
    <command name="..."><parameter name="..." />...</command>↵
    ...
</commands>↵
↵
```

More XML tokens and parameters may be added in later releases.

Controlling asynchronous notifications

The "notify" command may be used to enable or disable asynchronous notifications from the server. To enable or disable transport notifications:

```
notify: transport: {"true", "false"}↵
```

To enable or disable slot notifications:

```
notify: slot: {"true", "false"}↵
```

To enable or disable remote notifications:

```
notify: remote: {"true", "false"}↵
```

To enable or disable configuration notifications:

```
notify: configuration: {"true", "false"}↵
```

To enable or disable dropped frames notifications:

```
notify: dropped frames: {"true", "false"}↵
```

Multiple parameters may be specified. If no parameters are specified, the server returns the current state of all notifications:

```
209 notify:↵  
transport: {"true", "false"}↵  
slot: {"true", "false"}↵  
remote: {"true", "false"}↵  
configuration: {"true", "false"}↵  
↵
```

Retrieving device information

The "device info" command returns information about the connected deck device:

```
device info↵
```

The server will respond with:

```
204 device info:↵  
protocol version: {Version}↵  
model: {Model Name}↵  
unique id: {unique alphanumeric identifier}↵  
↵
```

Example of response from server:

```
204 device info:↵  
protocol version: 1.8↵  
model: Blackmagic Duplicator 4K↵  
unique id: 101112131415↵  
↵
```

Retrieving slot information

The "slot info" command returns information about a slot.

The specified slot will be queried:

```
slot info: slot id: {Slot ID}↵
```

The server will respond with slot specific information:

```
202 slot info:↵  
slot id: {Slot ID}↵  
status: {"empty", "mounting", "error", "mounted"}↵  
volume name: {Volume name}↵  
recording time: {recording time available in seconds}↵  
video format: {disk's default video format}↵  
↵
```

Asynchronous slot information change notification is disabled by default and may be configured with the "notify" command. When enabled, changes in slot state will generate a "502 slot info:" asynchronous message with the same parameters as the "202 slot info:" message.

Retrieving transport information

The "transport info" command returns the state of the transport:

```
transport info ↵
```

The server responds with transport specific information:

```
208 transport info:↵
status: {"stopped","record"}↵
display timecode: {timecode}↵
timecode: {timecode}↵
```

The "timecode" value is the timecode within the current timeline for playback or the clip for record. The "display timecode" is the timecode displayed on the front of the deck. The two timecodes will differ in some deck modes.

Asynchronous transport information change notification is disabled by default and may be configured with the "notify" command. When enabled, changes in transport state will generate a "508 transport info:" asynchronous message with the same parameters as the "208 transport info:" message.

Video Formats

The following video formats are currently supported on Blackmagic Duplicator 4K:

SD

525i59.94 NTSC

625i50 PAL

HD

720p50	1080p30
720p59.94	1080i50
720p60	1080p50
1080p23.98	1080i59.94
1080p24	1080p59.94
1080p25	1080i60
1080p29.97	1080p60

Ultra HD

2160p23.98	2160p30
2160p24	2160p50
2160p25	2160p59.94
2160p29.97	2160p60

Duplicator 4K supports progressive segmented frame modes, and automatically detects level A and level B 3G-SDI formats for 1080p50, 1080p59.94 and 1080p60.

File Formats

Duplicator 4K supports the following file formats:

- H.264Low
- H.264Medium
- H.264High
- H.265Low
- H.265Medium
- H.265High

Querying and updating configuration information

The "configuration" command may be used to query the current configuration of the deck:

```
configuration↵
```

The server returns the configuration of the deck:

```
211 configuration:↵  
video input: {"SDI", "optical"}↵  
↵
```

One or more configuration parameters may be specified to change the configuration of the deck.

To change the current video input:

```
configuration: video input: {"SDI", "optical"}↵
```

Configuring the watchdog

The "watchdog" command instructs the deck to monitor the connected client and terminate the connection if the client is inactive for at least a specified period of time.

To configure the watchdog:

```
watchdog: period: {period in seconds}↵
```

To avoid disconnection, the client must send a command to the server at least every {period} seconds.

Note that if the period is set to 0 or less than 0, connection monitoring will be disabled.

Configuring the record mode

Use the 'record mode' command to select the deck recording mode:

```
configuration: record mode: {"Duplicate", "SingleDisk",  
"DiskOverwrite"}↵
```

Configuring the file format

The 'file format' command instructs the deck to switch to a specific file format for codec and bit rate:

```
configuration: file format: {"H.264High", "H.264Medium", "H.264Low",  
"H.265High", "H.265Medium", "H.265Low"}↵
```

ヘルプ

ヘルプライン

すぐに情報が必要な方は、Blackmagic Designオンラインサポートページで、Blackmagic Duplicator 4Kの最新サポート情報を確認できます。

Blackmagic Design オンラインサポートページ

最新のマニュアル、ソフトウェア、サポートノートは、www.blackmagicdesign.com/jp/supportのBlackmagicサポートセンターで確認できます。

Blackmagic Designフォーラム

弊社ウェブサイトのBlackmagic Designフォーラムは、様々な情報やクリエイティブなアイデアを共有できる有益なリソースです。経験豊富なユーザーやBlackmagic Designスタッフによって、すでに多くの問題の解決策が公開されていますので、このフォーラムを参考にすることで、現在の問題をすばやく解決できることがあります。ぜひご利用ください。Blackmagicフォーラムには、<http://forum.blackmagicdesign.com> からアクセスできます。

Blackmagic Designサポートに連絡する

サポートページやフォーラムで必要な情報を得られなかった場合は、サポートページの「メールを送信」ボタンを使用して、サポートのリクエストをメール送信してください。あるいは、サポートページの「お住まいの地域のサポートオフィス」をクリックして、お住まいの地域のBlackmagic Designサポートオフィスに電話でお問い合わせください。

現在インストールされているソフトウェアのバージョンを確認

どのバージョンのBlackmagic Duplicator Utilityソフトウェアがコンピューターにインストールされているか確認するには、「About Blackmagic Duplicator Utility」ウィンドウを開きます。

- macOSでは、アプリケーションフォルダーから「Blackmagic Duplicator Utility」を開きます。アプリケーションメニューから「About Blackmagic Duplicator Utility」を選択し、バージョンを確認します。
- Windows 8.1では、スタートページのBlackmagic Duplicator UtilityタイルからBlackmagic Duplicator Utilityを開きます。ヘルプメニューをクリックして「About Blackmagic Duplicator Utility」を選択し、バージョンを確認します。
- Windows 10では、スタートメニューあるいはスタート画面から「Blackmagic Duplicator Utility」を開きます。ヘルプメニューをクリックして「About Blackmagic Duplicator Utility」を選択し、バージョンを確認します。

最新のソフトウェアアップデートを入手する

コンピューターにインストールされたBlackmagic Duplicator Utilityのバージョンを確認した後、Blackmagicサポートセンター (www.blackmagicdesign.com/jp/support) で最新のソフトウェア・アップデートをチェックしてください。常に最新のソフトウェアを使用することを推奨しますが、重要なプロジェクトの実行中は、ソフトウェアのアップデートは行わない方がよいでしょう。

規制に関する警告

欧州連合内での電気機器および電子機器の廃棄処分



製品に記載されている記号は、当該の機器を他の廃棄物と共に処分してはならないことを示しています。機器を廃棄するには、必ずリサイクルのために指定の回収場所に引き渡してください。機器の廃棄において個別回収とリサイクルが行われることで、天然資源の保護につながり、健康と環境を守る方法でリサイクルが確実に行われるようになります。廃棄する機器のリサイクルのための回収場所に関しては、お住まいの地方自治体のリサイクル部門、または製品を購入した販売業者にご連絡ください。



この機器は、FCC規定の第15部に準拠し、クラスAデジタル機器の制限に適合していることが確認されています。これらの制限は、商用環境で機器を使用している場合に有害な干渉に対する妥当な保護を提供するためのものです。この機器は無線周波エネルギーを生成、使用、放出する可能性があります。また、指示に従ってインストールおよび使用しない場合、無線通信に有害な干渉を引き起こす恐れがあります。住宅地域で、この製品を使用すると有害な干渉を引き起こす可能性があります。その場合はユーザーが自己責任で干渉に対処する必要があります。

動作は次の2つを条件とします：

- 1 本機は、有害な干渉を起こさない。
- 2 本機は希望しない動作を発生しかねない干渉を含む、いかなる受信干渉も受け入れる必要がある。

ISED Canadaステートメント

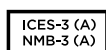

本機は、カナダのクラスAデジタル機器の規格に準拠しています。

本機のいかなる改造、あるいは目的の用途以外での使用は、これらの規格への順守を無効にすることがあります。

本機は、商用環境で目的の用途に順守した使用においてテストを行なっています。非商用環境で使用された場合、無線妨害を引き起こす可能性があります。

安全情報

感電を避けるため、当製品は必ずアース端子付きコンセントに接続してください。不確かな場合は、資格を持つ電気技師に連絡してください。

感電のリスクを減らすため、水が跳ねたり、滴るような場所には置かないでください。

この製品は、周囲温度が最高40度までの熱帯地区での使用に対応しています。

通気が妨げられないように、この製品の周囲は通気に十分なスペースを開けるようにしてください。

ラックマウントする場合は、隣接する機器により通気が妨げられないようにしてください。

この製品の内部には、ユーザーが保守できる部品はありません。サービスに関しては、お近くのBlackmagic Designのサービスセンターにお問い合わせください。

一部の製品は、SFP（スモールフォームファクタ・トランシーバー）光ファイバーモジュールを接続可能です。レーザークラスのクラス1のSFP光モジュールを使用。

推奨されるBlackmagic Design SFPモジュール：

- 3G-SDI : PL-4F20-311C
- 6G-SDI : PL-8F10-311C
- 12G-SDI : PL-TG10-311C



海拔2000m以上では使用しないでください。

カリフォルニア州ステートメント

この製品のユーザーは、六価クロムを含む化学物質にさらされる可能性があります。カリフォルニア州は、六価クロムは発がん性があり、先天異常や生殖機能へ危害を及ぼす物質であると認識しています。

詳細は、以下のウェブサイトをご確認ください。 www.P65Warnings.ca.gov

正規サービススタッフへの注意



警告 - 二極/中性ヒューズ

この機器の電源供給には、電圧線と中性線の両方にヒューズが使われており、ノルウェーのIT電力分配システムへの接続にも適しています。

保証

12ヶ月限定保証

Blackmagic Designは、お買い上げの日から12ヶ月間、Blackmagic Duplicator 4Kの部品および仕上がりについて瑕疵がないことを保証します。この保証期間内に製品に瑕疵が見つかった場合、Blackmagic Designは弊社の裁量において部品代および人件費無料で該当製品の修理、あるいは製品の交換のいずれかで対応いたします。

この保証に基づいたサービスを受ける際、お客様は必ず保証期限終了前にBlackmagic Designに瑕疵を通知し、適応する保証サービスの手続きを行ってください。お客様の責任において不良品を梱包し、Blackmagic Designが指定するサポートセンターへ配送料前払で送付いただきますようお願い致します。理由の如何を問わず、Blackmagic Designへの製品返送のための配送料、保険、関税、税金、その他すべての費用はお客様の自己負担となります。

不適切な使用、または不十分なメンテナンスや取扱いによる不具合、故障、損傷に対しては、この保証は適用されません。Blackmagic Designはこの保証で、以下に関してサービス提供義務を負わないものとします。a) 製品のインストールや修理、サービスを行うBlackmagic Design販売代理人以外の者によって生じた損傷の修理、b) 不適切な使用や互換性のない機器への接続によって生じた損傷の修理、c) Blackmagic Designの部品や供給品ではない物を使用して生じたすべての損傷や故障の修理、d) 改造や他製品との統合により時間増加や製品の機能低下が生じた場合のサービス。この保証は Blackmagic Designが保証するもので、明示または黙示を問わず他の保証すべてに代わるものです。Blackmagic Designとその販売社は、商品性と特定目的に対する適合性のあらゆる黙示保証を拒否します。Blackmagic Designの不良品の修理あるいは交換の責任が、特別に、間接的、偶発的、または結果的に生じる損害に対して、Blackmagic Designあるいは販売社がそのような損害の可能性についての事前通知を得ているか否かに関わらず、お客様に提供される完全唯一の救済手段となります。Blackmagic Designはお客様による機器のあらゆる不法使用に対して責任を負いません。Blackmagic Designは本製品の使用により生じるあらゆる損害に対して責任を負いません。使用者は自己の責任において本製品を使用するものとします。

© Copyright 2019 Blackmagic Design 著作権所有、無断複写・転載を禁じます。「Blackmagic Design」、「DeckLink」、「HDLINK」、「Workgroup Videohub」、「Videohub」、「Intensity」、「Leading the creative video revolution」は、米国ならびにその他諸国での登録商標です。その他の企業名ならびに製品名全てはそれぞれ関連する会社の登録商標である可能性があります。ThunderboltおよびThunderboltのロゴは、米国またはその他諸国のIntel Corporationの登録商標です。

Blackmagicdesign



Manuel d'utilisation et d'installation

Blackmagic Duplicator 4K

Février 2019

Français



Bienvenue

Nous vous remercions d'avoir fait l'acquisition du Blackmagic Duplicator 4K.

Nous sommes ravis de pouvoir présenter le Blackmagic Duplicator 4K, car c'est une solution qui vous permettra de distribuer du contenu Ultra HD de haute qualité directement à vos clients. Le duplicateur enregistre sur 25 cartes SD indépendantes dans tous les types de formats SD, HD et Ultra HD jusqu'à 2160p60 avec une compression H.264 largement utilisée ou une compression H.265. Vous obtenez ainsi un contenu d'excellente qualité à des fréquences d'images élevées et à un débit suffisamment bas pour utiliser des cartes bon marché et bénéficier d'un enregistrement plus long.

Le Blackmagic Duplicator 4K est très facile à installer et à utiliser. Le panneau avant intègre un écran LCD et des commandes pour vous permettre de modifier les paramètres et de contrôler l'appareil. Vous pouvez également contrôler le duplicateur à distance via Ethernet ou en le connectant à un port RS-422. Il est également possible de fabriquer votre propre solution de contrôle et de contrôler l'appareil à l'aide du protocole Ethernet Blackmagic HyperDeck.

L'encodeur vidéo H.265 intégré enregistre de la vidéo haute qualité en temps réel sur des cartes SD peu onéreuses dans des formats vidéo jusqu'à Ultra HD 2160p60. Vous pouvez ainsi enregistrer de la vidéo Ultra HD sans devoir utiliser les cartes les plus performantes du marché. Dans la nouvelle version 1.2 du logiciel Blackmagic Duplicator 4K, nous avons ajouté la compression H.264. Vous pouvez donc choisir d'enregistrer des fichiers H.264, pour une meilleure compatibilité !

Le Blackmagic Duplicator 4K mesure 1U de haut, il est donc possible de relier en chaîne plusieurs unités dans un rack portable et de les emporter sur le lieu de tournage. Vous pouvez ainsi enregistrer simultanément sur des centaines de cartes SD.

Ce manuel d'utilisation contient toutes les informations nécessaires pour utiliser le Blackmagic Duplicator 4K.

Consultez notre page d'assistance sur www.blackmagicdesign.com/fr pour obtenir la dernière version de ce manuel et les mises à jour du logiciel Blackmagic Duplicator 4K. Nous vous recommandons de mettre le logiciel à jour régulièrement afin de travailler avec les fonctions les plus récentes. N'oubliez pas d'enregistrer vos coordonnées lorsque vous téléchargerez le logiciel afin d'être tenu informé des dernières mises à jour. Nous souhaitons continuer à améliorer nos produits, n'hésitez donc pas à nous faire part de vos commentaires !

Grant Petty

CEO Blackmagic Design

Contents

Blackmagic Duplicator 4K

Mise en route	79
Branchement de l'alimentation	79
Branchement de la vidéo et de l'audio	79
Liaison en chaîne	80
Insertion et formatage des cartes SD	81
Enregistrement	82
Régler le mode d'enregistrement	82
Configuration du Codec	83
Régler le débit	84
Enregistrement des clips	85
Voyants d'état LED	85
Ajout d'enregistrements	86
Verrouillage du Blackmagic Duplicator 4K	87
Relier plusieurs Blackmagic Duplicator 4K en chaîne	87
Paramètres du menu à l'écran	89
Menu Record	89
Menu Settings	94
Paramètres About	95
Logiciel Blackmagic Duplicator Utility	95
Mettre à jour votre Blackmagic Duplicator 4K	95
Nommer les fichiers	95
Installation d'un module Optical Fiber SDI Module en option	96
Port RS-422	97
Qu'est-ce que le contrôle RS-422 ?	97
Utilisation d'un contrôleur RS-422 externe	97
RS-422 Developer Information	99
Contrôle à distance via Ethernet	99
Exemple de contrôle via un microcontrôleur Arduino	100
Protocole Ethernet Blackmagic HyperDeck	102
Protocol Commands	102
Protocol Details	103
Configuring the watchdog	108
Configuring the record mode	108
Configuring the file format	108
Assistance	109
Avis réglementaires et informations de sécurité	110
Informations de sécurité	111
Garantie	112

Mise en route

Il est très facile de mettre en route le Blackmagic Duplicator 4K !

Il suffit de le brancher à une source d'alimentation, de connecter une source vidéo et d'insérer jusqu'à 25 cartes SD. Si vous souhaitez enregistrer sur davantage de cartes SD, vous pouvez relier en chaîne plusieurs Blackmagic Duplicator 4K. C'est un jeu d'enfant car l'appareil est doté de connexions vidéo et de contrôle que vous pouvez connecter à chaque unité située en aval. Cette section du manuel vous explique pas à pas comment installer le Blackmagic Duplicator 4K afin de pouvoir commencer à enregistrer simultanément sur plusieurs cartes SD.

Branchement de l'alimentation

Pour alimenter le Blackmagic Duplicator 4K, il suffit de brancher un cordon d'alimentation CEI standard à l'entrée d'alimentation AC 110-240V située sur la face arrière de l'appareil.

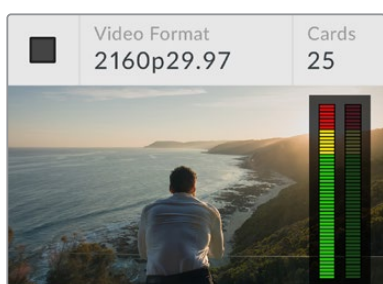

Lorsque le Blackmagic Duplicator 4K est alimenté, l'écran d'accueil apparaît sur l'écran intégré.

Écran d'accueil

L'écran d'accueil affiche l'image de la source vidéo et des informations telles que le format de la source vidéo, le nombre de cartes SD insérées, un voyant d'état pour l'enregistrement et des vumètres pour vérifier les niveaux audio de votre source vidéo.

Branchement de la vidéo et de l'audio

Branchez votre source vidéo à l'entrée 12G-SDI située sur la face arrière de l'appareil. Le Blackmagic Duplicator 4K détecte automatiquement le format de l'entrée et l'affiche sur l'écran d'accueil.

Les connecteurs BNC d'entrée et de sortie SDI prennent en charge les signaux vidéo jusqu'à 12G-SDI, vous pouvez donc brancher de la vidéo SD, HD ou Ultra HD jusqu'à 2160p60 sur un seul câble BNC. Comme la sortie en boucle correspondra toujours au format de votre source vidéo, vous pouvez acheminer le même signal vers d'autres équipements vidéo SDI, ou relier en boucle plusieurs Blackmagic Duplicator 4K. Le Blackmagic Duplicator 4K prend également en charge les modes d'images segmentées progressives et détecte automatiquement les formats 3G-SDI de niveau A et de niveau B pour 1080p50, 1080p59.94 et 1080p60.

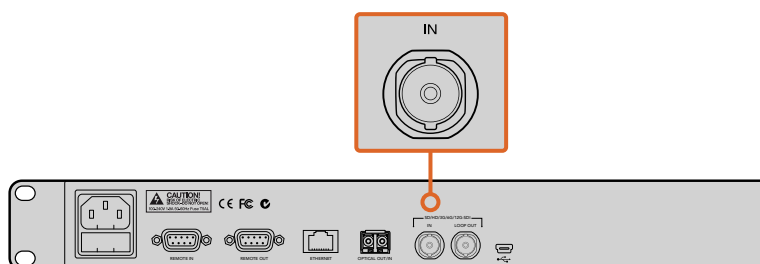

Branchez votre source vidéo à l'entrée SDI. L'audio est intégré au signal vidéo SDI.

Le Blackmagic Duplicator 4K prend en charge 2 canaux d'audio SDI intégré, vous n'avez ainsi pas besoin de brancher de signal audio car celui-ci est déjà connecté via l'entrée vidéo SDI.

CONSEIL Vous pouvez vérifier les niveaux audio de votre source vidéo sur l'écran d'accueil.

Liaison en chaîne

Vous pouvez relier en chaîne plusieurs Blackmagic Duplicator 4K pour enregistrer la vidéo sur davantage de cartes SD. Par exemple, si vous souhaitez dupliquer 100 cartes, il suffit de relier 4 unités en chaîne.

- 1 Connectez la sortie RS-422 **Remote** située sur le premier Blackmagic Duplicator 4K à l'entrée **Remote** située sur le deuxième appareil. Répétez ce procédé pour tous les appareils présents dans la chaîne.
- 2 De même, connectez la sortie en boucle SDI du premier appareil à l'entrée SDI du deuxième et répétez cette étape pour chaque unité en aval de la chaîne.
- 3 Sur le panneau de contrôle de chaque appareil, vous trouverez un bouton intitulé **REM**. Ce bouton permet d'activer le contrôle à distance entre les appareils. Appuyez sur le bouton **REM** de chaque appareil esclave jusqu'à la fin de la chaîne.

REMARQUE Veillez à ce que le bouton **REM** du premier appareil soit désactivé car cet appareil contrôle toutes les unités de la chaîne. Le premier appareil dont le bouton **REM** est éteint est l'appareil maître. Tous les boutons activés sur son panneau avant seront acheminés sur la sortie Remote, ce qui permet de contrôler les appareils situés en aval, dont les boutons **REM** sont activés. Tout type de produit télévisuel doté d'un port RS-422 peut faire office d'appareil maître car il prend en charge le protocole de contrôle à distance conforme aux normes de l'industrie.

Tous les Blackmagic Duplicator 4K de la chaîne sont maintenant prêts à suivre les commandes du premier appareil.

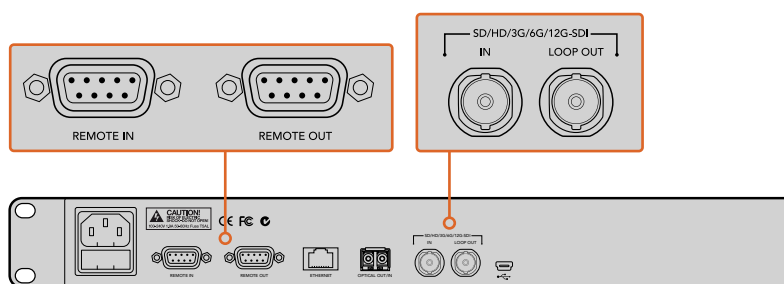

Les connecteurs **Remote** et **Loop** permettent de relier en chaîne plusieurs Blackmagic Duplicator 4K. Le connecteur **Loop** situé sur le dernier appareil de la chaîne peut également être utilisé pour relier en boucle la vidéo source à d'autres équipements SDI tels que le moniteur SmartView ou l'enregistreur à disque HyperDeck de chez Blackmagic.

Pour obtenir plus d'informations sur la liaison en chaîne de plusieurs appareils, consultez la section « Daisy Chaining Multiple Duplicators ».

Insertion et formatage des cartes SD

Le Blackmagic Duplicator 4K utilise des cartes SD de classe 10 standard, vous n'avez ainsi pas besoin d'acheter les cartes les plus performantes du marché. Les cartes SD sont disponibles dans les magasins de matériel de prises de vues. Certains supermarchés vendent également des cartes SD de classe 10.

CONSEIL Sur l'étiquette de toutes les cartes SD, vous trouverez un nombre situé entre 1 et 10 imprimé dans un petit cercle. Ce nombre représente la vitesse de la carte et 10 représente la carte la plus rapide. Toute carte affichant un cercle avec le nombre 10 est une carte SD de classe 10. Elle vous permet d'enregistrer de la vidéo Ultra HD au débit le plus élevé.

Insérer une carte SD :

- 1 Orientez les contacts dorés de la carte vers l'écran et positionnez la carte devant un des logements pour carte SD du Blackmagic Duplicator 4K.
- 2 Poussez délicatement la carte dans le logement jusqu'à ce qu'elle soit complètement insérée. Le Blackmagic Duplicator 4K vérifie rapidement la carte. Lorsque la carte est prête à enregistrer, le voyant d'état de l'enregistrement devient vert.

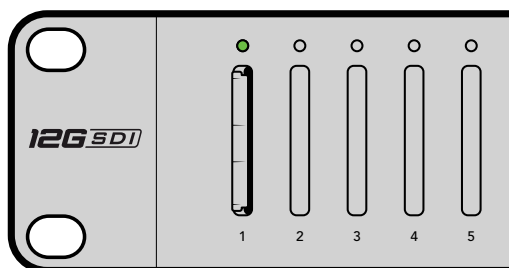
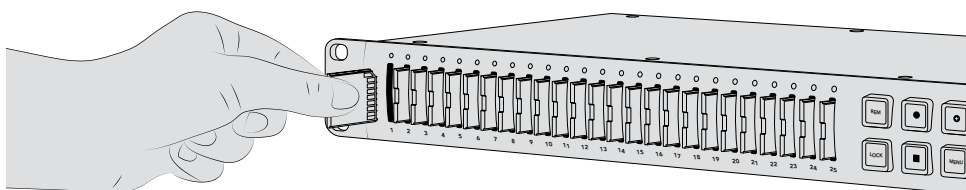

Orientez les contacts dorés de la carte vers l'écran et poussez délicatement la carte dans le logement jusqu'à ce qu'elle soit complètement insérée. Le voyant d'état devient vert lorsque la carte est prête à enregistrer.

Pour retirer une carte, il suffit de la tenir par le bord et de la tirer hors du logement.

CONSEIL Lorsque vous insérez une carte, veillez à ce qu'elle ne soit pas protégée en écriture. La protection en écriture se désactive en déplaçant le petit poussoir en plastique situé à gauche de la carte à l'emplacement le plus proche des connecteurs. Après l'enregistrement, vous pouvez réactiver la protection en écriture en faisant glisser le poussoir dans sa position initiale.

Formatage des cartes SD

Avant de commencer l'enregistrement, il faudra formater vos cartes SD au format exFAT. Ce format est compatible avec les ordinateurs macOS et Windows. Il est très facile de formater votre support à l'aide de la fonction **Format** du Blackmagic Duplicator 4K. Cette fonction permet de formater simultanément jusqu'à 25 cartes SD sur un seul appareil.

Formater vos cartes SD sur le Blackmagic Duplicator 4K :

- 1 Appuyez sur le bouton **MENU** du panneau de contrôle.
- 2 À l'aide des boutons multifonctions lumineux situés de chaque côté de l'écran, appuyez sur **Record**.
- 3 Appuyez sur la flèche gauche pour sélectionner le paramètre **Format cards**, puis appuyez sur **Format** en bas à droite du menu de l'écran.
- 4 Un message d'avertissement apparaît et vous demande de confirmer votre choix. Appuyez sur le bouton **Format** pour confirmer le formatage, ou sur **Cancel** pour l'annuler.
- 5 Une barre de progression indique la progression du formatage. Appuyez sur **OK** lorsque le formatage est terminé.
- 6 Appuyez sur le bouton **MENU** du panneau de contrôle pour revenir à l'écran d'accueil.

Appuyez sur le bouton **MENU** du panneau de contrôle pour revenir à l'écran d'accueil.

C'est tout ce que vous devez savoir pour démarrer ! Votre vidéo et votre audio sont connectés et vos cartes sont formatées, vous pouvez donc commencer à enregistrer.

CONSEIL Les différents types et tailles de cartes SD se formatent à des vitesses différentes, c'est pourquoi certaines cartes seront formatées plus rapidement que d'autres.

Enregistrement

Vous pouvez commencer à enregistrer immédiatement en appuyant sur le bouton d'enregistrement situé sur le panneau de contrôle. Toutefois, nous vous recommandons de régler préalablement le mode d'enregistrement, le codec et le débit car ils définissent le type d'enregistrement utilisé ainsi que la durée et la qualité de votre enregistrement.

Régler le mode d'enregistrement

Le Blackmagic Duplicator 4K possède les modes d'enregistrement suivants :

- **Duplicate** : enregistre simultanément sur toutes les cartes SD.
- **Single Disk** : enregistre sur une carte SD à la fois, dans l'ordre. L'enregistrement s'arrête lorsque la dernière carte est pleine.
- **Single Disk Overwrite** : enregistre sur une carte SD à la fois, dans l'ordre, et réécrit en boucle continue.

Mode Duplicate

En mode Duplicate, le Blackmagic Duplicator 4K enregistre la même vidéo simultanément sur toutes les cartes SD.

Mode Single Disk

Le Blackmagic Duplicator 4K est un enregistreur idéal pour de nombreuses utilisations, par exemple dans les domaines de la diffusion télévisée et de la sécurité. Il enregistre sur un logement pour carte SD à la fois et, lorsque la carte SD est pleine, l'enregistrement se poursuit sur la suivante. En mode Single Disk, l'enregistrement s'arrête lorsque toutes les cartes SD sont pleines. Comme le Blackmagic Duplicator 4K est doté de 25 logements, vous pouvez facilement enregistrer pendant une semaine entière. Pour un enregistrement sans interruption, vous pouvez échanger les cartes pleines par des cartes vides à tout moment.

Il est également possible de relier en chaîne plusieurs Blackmagic Duplicator 4K pour des enregistrements encore plus longs. Une fois que toutes les cartes sont pleines dans l'appareil principal, l'enregistrement se poursuit sur le premier appareil esclave, puis en chaîne sur tous les autres appareils connectés. L'enregistrement s'arrête lorsque la dernière carte du dernier appareil est pleine.

Mode Single Disk Overwrite

Lorsque le mode Single Disk Overwrite est activé, le Blackmagic Duplicator 4K retourne sur la première carte lorsque la dernière carte est pleine. L'enregistrement n'est ainsi pas interrompu. L'appareil enregistre sur un logement pour carte SD à la fois. Lorsque la carte SD de ce logement est pleine, il formate la carte du logement suivant et poursuit l'enregistrement.

Ce mode ressemble au mode Single Disk, toutefois, l'appareil formate et enregistre en boucle, plutôt que de s'arrêter lorsque la dernière carte est pleine. En mode Single Disk Overwrite, le Blackmagic Duplicator 4K continue d'enregistrer jusqu'à ce que vous appuyiez sur Stop.

CONSEIL Si vous enregistrez en mode Single Disk ou en mode Single Disk Overwrite, vous pouvez insérer des cartes SD vides à tout moment. Le Duplicator 4K continuera d'enregistrer tant qu'il y aura des cartes avec de l'espace libre dans un des 25 logements.

Pour régler le mode d'enregistrement :

- 1 Allumez le Blackmagic Duplicator 4K.
- 2 Appuyez sur le bouton **Menu** sur le panneau avant pour ouvrir le menu sur l'écran. Les boutons multifonctions à côté de l'écran s'allument pour indiquer les options dans le menu. Appuyez sur le bouton multifonction **Record**.

Au bas de l'écran du menu Record, des points indiquent le nombre d'options disponibles. Si vous souhaitez retourner au menu précédent, appuyez sur le bouton **Back** à n'importe quel moment. Utilisez les boutons < et > pour passer d'une option à l'autre.
- 3 Allez sur l'option **Mode**, et cliquez sur **Change**.
- 4 Appuyez sur le bouton **Select** pour utiliser le mode affiché. Le menu à l'écran indique l'option sélectionnée.
- 5 Appuyez sur le bouton **Back** pour retourner au menu **Record**. L'option sélectionnée s'affiche.

Pour obtenir plus d'informations sur la liaison en chaîne de plusieurs appareils, consultez les sections « Liaison en chaîne » et « Relier plusieurs Blackmagic Duplicator 4K en chaîne ».

CONSEIL Si vous enregistrez un événement important en mode Single Disk ou en mode Single Disk Overwrite, et que vous souhaitez retirer la carte SD avant qu'elle ne soit pleine, il suffit d'appuyer sur le bouton **Record** pendant trois secondes pour faire passer l'enregistrement sur la carte SD suivante. Lorsque vous enregistrez en mode Duplicate, vous pouvez appuyer sur le bouton **Append Record**. Pour en savoir plus, consultez la section « Ajout d'enregistrements ».

Configuration du Codec

Votre Blackmagic Duplicator 4K peut enregistrer des fichiers en utilisant des codecs de compression H.264 et H.265. Par défaut, le Duplicator 4K est réglé sur une compression H.264.

Changer le codec :

- 1 Appuyez sur le bouton **MENU**
- 2 Appuyez sur le bouton multifonction **Record** pour accéder aux paramètres d'enregistrement.
- 3 Entrez dans le paramètre **Codec** à l'aide des boutons directionnels et appuyez sur **Change**.
- 4 Utilisez les boutons directionnels pour sélectionner le codec souhaité, puis appuyez sur **Set** pour confirmer le changement. Vous pouvez également appuyer sur le bouton **MENU** du panneau de contrôle pour confirmer le changement et revenir à l'écran d'accueil.

REMARQUE Pour changer les codecs, assurez-vous d'avoir préalablement mis à jour votre Blackmagic Duplicator 4K avec la dernière version 1.1 du logiciel. Pour plus d'informations sur la mise à jour logicielle, consultez la section « Logiciel Blackmagic Duplicator Utility » de ce manuel.

Choisir le codec adapté

Pour une compatibilité optimale, nous vous recommandons d'utiliser le codec H.264. C'est pour cette raison que le codec du Blackmagic Duplicator 4K est réglé par défaut sur H.264.

Le codec H.265 est parfait pour compresser des fichiers vidéo Ultra HD de haute qualité, mais il est assez nouveau sur le marché. En l'utilisant vous pouvez rencontrer des problèmes de compatibilité avec certains ordinateurs et équipements de lecture vidéo.

Chaque codec a ses avantages. Le codec H.265 vous permet d'utiliser des cartes SD moins chères, car le débit sera moins élevé et les fichiers plus légers pour une même qualité d'image. Le codec H.264 est un très bon choix si la compatibilité des fichiers est essentielle à votre projet.

Régler le débit

Les trois options disponibles relatives au débit du Blackmagic Duplicator 4K sont Low, Medium et High. Ils vous permettent de choisir la quantité de données écrites chaque seconde par l'encodeur H.265 intégré. Par défaut, ce paramètre est réglé sur Medium pour vous offrir un enregistrement de haute qualité et une taille de fichier raisonnable. Toutefois, il est facile de modifier ce paramètre à l'aide du menu de l'écran.

Modifier le débit :

- 1 Appuyez sur le bouton **MENU**.
- 2 Appuyez sur le bouton multifonction **Record** pour accéder aux paramètres d'enregistrement.
- 3 Naviguez entre les paramètres **Bit Rate** à l'aide des boutons directionnels et appuyez sur **Change**.
- 4 Utilisez les boutons directionnels pour sélectionner le débit souhaité, puis appuyez sur **Set** pour confirmer le changement. Vous pouvez également appuyer sur le bouton **MENU** du panneau de contrôle pour confirmer le changement et revenir à l'écran d'accueil.

REMARQUE Les débits élevés enregistrent les images dans une meilleure qualité mais remplissent les cartes plus rapidement ou nécessitent des cartes plus grandes et plus onéreuses. Toutefois, le fait de réduire le débit de transfert des données augmente le temps d'enregistrement de la carte, mais réduit également la qualité de l'image.

Nous vous recommandons d'essayer plusieurs débits afin d'obtenir la qualité d'image souhaitée avec la plus petite taille de fichier possible.

Enregistrement des clips

Pour commencer à enregistrer, il suffit d'appuyer sur le bouton d'enregistrement situé sur le panneau de contrôle. Lors de l'enregistrement, les voyants d'état de chaque logement s'allument en rouge. Lorsque vous arrêtez l'enregistrement, le voyant LED s'allume en vert pour vous indiquer que l'enregistrement a réussi et que la carte est prête à enregistrer un autre clip. Vous pouvez facilement vérifier vos enregistrements sur un ordinateur équipé d'un logement pour carte SD ou avec un lecteur externe, mais aussi sur une télévision HDMI prenant en charge les cartes SD et le système de fichiers exFAT.

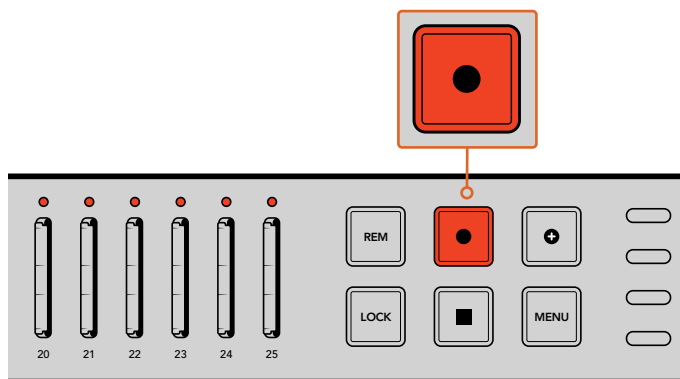

Appuyez sur le bouton d'enregistrement pour démarrer l'enregistrement. Les voyants d'état situés au-dessus de chaque logement s'allument en rouge pour vous indiquer que les cartes SD enregistrent.

Voyants d'état LED

Les voyants d'état situés au-dessus de chaque logement pour carte SD s'allument de différentes couleurs pour vous indiquer l'état du logement. Par exemple, lorsque vous insérez une carte SD, la LED du logement s'allume en vert une fois que la carte a été reconnue et qu'elle est prête à enregistrer.

Vous trouverez ci-dessous une description de la couleur, de l'action et de l'état de chaque LED :



Voyant vert fixe

Prêt à enregistrer. Le voyant devient vert pour vous indiquer que la carte SD est prête à enregistrer.



Voyant rouge fixe

Enregistrement. Le voyant devient rouge lorsqu'un clip est en cours d'enregistrement.



Clignotement rouge

Enregistrement, mais la carte est presque pleine. Le voyant clignote lorsqu'il reste moins de 3 minutes d'enregistrement sur la carte.



Clignotement rapide du voyant rouge

Perte d'images. La vitesse d'écriture de la carte SD n'est pas assez rapide par rapport à la vitesse d'enregistrement.



Voyant jaune fixe

Carte pleine, protégée en écriture ou problème d'écriture. Lorsque le voyant est jaune fixe durant l'enregistrement, il se peut que votre carte SD soit défectueuse, protégée en écriture, pas encore formatée, ou qu'il ne lui reste que 10 secondes d'espace disponibles. Essayez de déplacer l'interrupteur de verrouillage sur **Unlock**, de réduire le débit, d'utiliser une carte SD plus rapide, de la formater, ou de l'échanger avec une autre carte.

Il est important de ne pas retirer la carte SD durant l'enregistrement, toutefois le Blackmagic Duplicator 4K essaiera de conserver le système de fichiers de la carte en ordre le cas échéant. Certains systèmes d'exploitation utilisés pour visionner la carte ne sont pas assez robustes et ils peuvent détecter l'enregistrement comme étant défectueux. C'est pourquoi il est judicieux d'arrêter l'enregistrement avant de retirer la carte. Si vous souhaitez pouvoir distribuer des cartes avant la fin d'un spectacle, nous vous recommandons d'utiliser plusieurs duplicateurs et d'arrêter l'enregistrement sur un des appareils pour distribuer les cartes provenant de cet appareil, pendant que les autres unités enregistrent.

CONSEIL Les cartes SD de classe 10 peuvent enregistrer des images avec tous les débits de données pris en charge par le Blackmagic Duplicator 4K. Vous pouvez toutefois enregistrer à des débits moins élevés avec des cartes moins performantes. Par exemple, si vous enregistrez de la vidéo de surveillance pendant de longues durées, vous n'aurez pas besoin de la plus haute qualité vidéo. Nous recommandons de toujours effectuer un enregistrement test pour vérifier que la carte SD peut enregistrer de la vidéo au débit choisi. Pour obtenir plus d'informations au sujet du classement des vitesses de carte SD, consultez la section « Insertion et formatage des cartes SD ».

Ajout d'enregistrements

Lorsque vous enregistrez en mode Duplicate, si vous le souhaitez, vous pouvez enregistrer un nouveau clip et l'ajouter au clip précédent pour n'obtenir qu'un seul clip. Par exemple, lorsque vous enregistrez un spectacle composé de plusieurs éléments, vous pouvez enregistrer chaque élément séparément et les rassembler dans un seul clip grâce à la fonction Ajout d'enregistrements.

- 1 Enregistrez le premier clip à l'aide du bouton d'enregistrement. Appuyez sur Stop.
- 2 Lorsque vous reprenez l'enregistrement, appuyez sur le bouton +. Ce bouton ainsi que le bouton d'enregistrement s'allument pour vous indiquer que vous enregistrez un clip qui sera ajouté au clip précédent.
- 3 Appuyez sur Stop. Le nouveau clip est ajouté au premier clip et les deux clips sont sauvegardés en tant qu'un seul clip.

CONSEIL Lorsque vous utilisez la fonction d'ajout d'enregistrements, il n'y a pas de limite au nombre de clips que vous pouvez ajouter au premier clip. La seule chose à considérer est la taille de la carte et la durée des enregistrements.

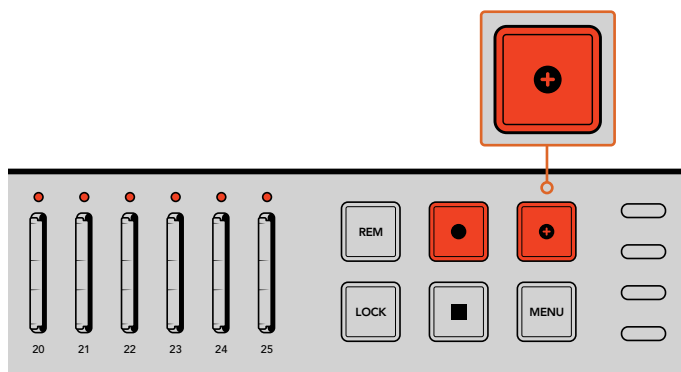

Appuyez sur le bouton + pour ajouter un nouveau clip au clip précédent.

CONSEIL Lorsque vous enregistrez en mode Single Disk ou en mode Single Disk Overwrite, il suffit d'appuyer sur le bouton **Record** pendant trois secondes pour faire passer l'enregistrement sur la carte suivante et libérer la carte actuelle. C'est très pratique pour enregistrer immédiatement un événement important sans interrompre l'enregistrement. Pour plus d'informations sur les modes Single Disk et Single Disk Overwrite, consultez la section « Régler le mode d'enregistrement ». Lorsque vous enregistrez en mode Duplicate, vous pouvez appuyer sur le bouton **Append Record**. Pour en savoir plus, consultez la section « Ajout d'enregistrements ».

Verrouillage du Blackmagic Duplicator 4K

Lorsque vous enregistrez un événement important, vous pouvez choisir de verrouiller le panneau de contrôle afin que l'enregistrement ne soit pas accidentellement interrompu. Il est également pratique de verrouiller les appareils esclaves reliés en chaîne afin qu'aucune manipulation sur un des appareils n'interrompe l'enregistrement.

Le verrouillage s'active et se désactive avec le bouton **LOCK** situé sur chaque appareil. Il est peu probable de déverrouiller un boîtier par accident, car il faudrait appuyer sur le bouton **LOCK** de chaque appareil pendant deux secondes.

Pour verrouiller un Blackmagic Duplicator 4K :

- 1 Appuyez sur le bouton **LOCK** du panneau de contrôle du Blackmagic Duplicator 4K.
- 2 Pour déverrouiller l'appareil, appuyez et maintenez le bouton **LOCK** enfoncé. Après ces deux secondes, l'appareil est déverrouillé.

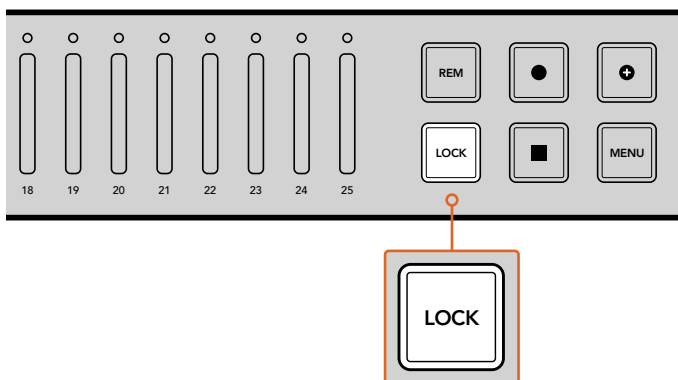

Le verrouillage du panneau de contrôle du Blackmagic Duplicator 4K permet d'éviter d'interrompre l'enregistrement accidentellement.

Relier plusieurs Blackmagic Duplicator 4K en chaîne

Si vous avez besoin d'enregistrer vos images sur plus de 25 cartes SD, vous pouvez relier plusieurs Blackmagic Duplicator 4K en chaîne. Les appareils partageront alors le même signal vidéo via le connecteur **LOOP** de chaque unité. De plus, ils communiqueront entre eux via les connecteurs **REMOTE** RS-422.

Pour relier les Blackmagic Duplicator 4K en chaîne :

- 1 Connectez le port **REMOTE OUT** RS-422 du premier appareil au port **REMOTE IN** du deuxième appareil à l'aide d'un câble série doté d'un connecteur DB-9. Les câbles séries dotés d'un connecteur DB-9 sont disponibles dans le commerce.
- 2 Connecter la sortie SDI **LOOP** du premier appareil à l'entrée SDI de la deuxième unité.

Rien de plus simple ! Pour relier davantage de Blackmagic Duplicator 4K en chaîne, connectez les sorties **REMOTE** et **LOOP** aux entrées **REMOTE** et **LOOP** de l'appareil suivant.

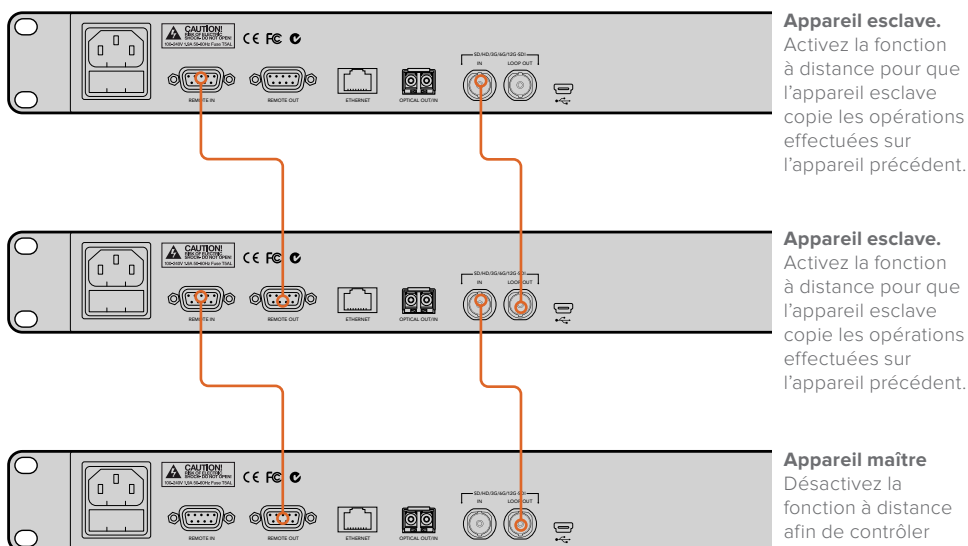

Pour relier davantage de Blackmagic Duplicator 4K en chaîne, connectez la sortie **LOOP** à l'entrée SDI **LOOP** de l'appareil suivant. De la même façon, connectez la sortie **REMOTE** à l'entrée **REMOTE** de l'appareil suivant.

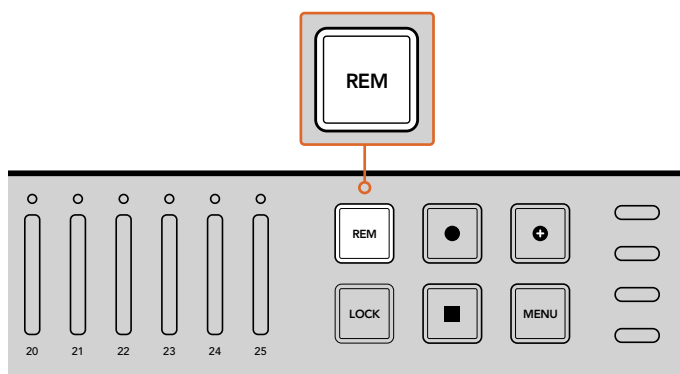

Appuyez sur le bouton **REM** de chaque appareil esclave relié en chaîne afin qu'il puisse être contrôlé à distance par le premier appareil.

REMARQUE Veillez à appuyer sur le bouton **REM** de chaque appareil esclave pour activer le contrôle à distance. Le bouton **REM** s'allume lorsque cette fonction est activée. Appuyez sur ce même bouton pour la désactiver.

Il est judicieux d'effectuer un essai pour vous assurer que toutes les unités sont contrôlées par l'appareil maître avant de démarrer l'enregistrement final. Si les appareils esclaves ne répondent pas aux commandes de l'appareil maître, vérifiez que le bouton **REM** de l'appareil maître est désactivé et que les boutons **REM** des appareils esclaves sont activés.

Paramètres du menu à l'écran

Tous les paramètres du Blackmagic Duplicator 4K peuvent être réglés à l'aide du menu à l'écran et des boutons multifonctions. Ces boutons se trouvent autour de l'écran et s'allument en fonction du paramètre affiché à l'écran.

Pour régler les paramètres :

- 1 Appuyez sur le bouton **MENU** du panneau de contrôle pour ouvrir le menu à l'écran.
- 2 Utilisez les boutons multifonctions pour naviguer dans le menu.
- 3 Une fois le paramètre sélectionné, appuyez sur le bouton multifonction change.
- 4 Réglez le paramètre puis appuyez sur set pour confirmer le changement.

Vous pouvez annuler le changement en appuyant sur le bouton multifonction back afin de revenir à l'action précédente. Vous pouvez également simplement appuyer sur le bouton **MENU** du panneau de contrôle qui ouvrira la page d'accueil.

Menu Record

Le menu record vous permet de changer la source, de régler le débit, d'activer et de désactiver le déclenchement de l'enregistrement et de formater vos cartes SD.

Paramètre Video source

Ce paramètre permet de choisir entre l'entrée SDI et fibre optique, si le module SDI fibre optique est installé.

Paramètre Mode

Utilisez ce paramètre pour sélectionner un mode d'enregistrement :

Duplicate

Enregistre la même vidéo simultanément sur toutes les cartes SD.

Single Disk

Enregistre sur une carte SD à la fois et, lorsque la carte SD est pleine, l'enregistrement se poursuit sur la suivante. Quand toutes les cartes sont pleines, l'enregistrement s'arrête. Lorsque plusieurs Duplicator 4K sont reliés en chaîne, l'enregistrement continue sur l'appareil suivant jusqu'à ce que toutes les cartes SD soient pleines.

Single Disk Overwrite

Enregistrement en boucle. Enregistre sur une carte SD à la fois et, lorsque la carte SD est pleine, l'enregistrement se poursuit sur la suivante. Quand toutes les cartes sont pleines, le Duplicator 4K retourne sur la première carte SD et poursuit l'enregistrement.

Codec

Utilisez ce paramètre pour configurer les codecs de compression de votre Blackmagic Duplicator 4K pour l'enregistrement. Vous pouvez choisir un codec H.264 ou H.265.

Vous trouverez ci-dessous une description de chaque codec.

H.264

C'est un codec de compression extrêmement répandu. Il offre un bon compromis entre la qualité de l'image et la taille des fichiers. La plupart des appareils de lecture de ces dix dernières années seront capables de lire des fichiers compressés avec ce codec. Il est adapté pour les fichiers vidéo HD.

H.265

C'est un codec de compression très efficace. Pour une même qualité d'image, il peut réduire la taille des fichiers vidéo de moitié comparé au H.264. Ce codec est excellent pour compresser des vidéos de haute qualité ou Ultra HD. Cependant, il nécessite du matériel et des logiciels de lecture avancés qui soient capables de lire ces fichiers vidéo.

REMARQUE Pour plus d'informations sur les différences entre H.264 et H.265, reportez-vous à la section « Enregistrement » de ce manuel.

Paramètre Bit Rate

Le paramètre Bit Rate détermine la durée et la qualité de la vidéo enregistrée sur les cartes SDI. Trois options sont disponibles :

High

Choisissez cette option si vous souhaitez enregistrer la meilleure qualité vidéo possible légèrement compressée.

Medium

Choisissez cette option si vous souhaitez enregistrer davantage de vidéo sur vos cartes SD dans une bonne qualité d'image.

Low

Choisissez cette option si vous souhaitez enregistrer une grande quantité d'images sur vos cartes SD en qualité inférieure. Ce réglage applique une compression importante sur la vidéo, des artefacts pourraient donc apparaître.

REMARQUE L'encodeur H.265 intégré utilise la technologie de compression la plus récente. Les enregistrements de vos images seront donc légers et de très bonne qualité. Même en réglant le paramètre sur la qualité la plus basse et avec une forte compression, la qualité de l'enregistrement est tout de même très bonne.

Débits en fonction du format vidéo

Ultra HD			
Format vidéo	Paramètre Bit Rate	Débit (Mb/s) H.264	Débit (Mb/s) H.264
2160p60	High	75	50
	Medium	66	38
	Low	50	20
2160p59.94	High	75	50
	Medium	66	38
	Low	50	20

Ultra HD			
Format vidéo	Paramètre Bit Rate	Débit (Mb/s) H.264	Débit (Mb/s) H.264
2160p50	High	72	48
	Medium	61	32
	Low	42	16
2160p30	High	50	30
	Medium	37	20
	Low	24	10
2160p29.97	High	50	30
	Medium	37	20
	Low	24	10
2160p25	High	40	25
	Medium	32	18
	Low	20	10
2160p24	High	40	25
	Medium	32	18
	Low	20	10
2160p23.98	High	40	25
	Medium	32	18
	Low	20	10

HD			
Format vidéo	Paramètre Bit Rate	Débit (Mb/s) H.264	Débit (Mb/s) H.264
1080p60	High	40	20
	Medium	32	15
	Low	20	10
1080i60	High	40	20
	Medium	32	15
	Low	20	10
1080p59.94	High	40	20
	Medium	32	15
	Low	20	10
1080i59.94	High	40	20
	Medium	32	15
	Low	20	10
1080p50	High	36	20
	Medium	28	15
	Low	18	10

HD			
Format vidéo	Paramètre Bit Rate	Débit (Mb/s) H.264	Débit (Mb/s) H.264
1080i50	High	36	20
	Medium	28	15
	Low	18	10
1080p30	High	28	15
	Medium	20	11
	Low	11	7
1080p29.97	High	28	15
	Medium	20	11
	Low	11	7
1080p25	High	24	15
	Medium	16	10
	Low	9	6
1080p24	High	24	15
	Medium	15	10
	Low	8	6
1080p23.98	High	24	15
	Medium	15	10
	Low	8	6
720p60	High	25	12
	Medium	17	10
	Low	9	8
720p59.94	High	25	12
	Medium	17	10
	Low	9	8
720p50	High	20	12
	Medium	14	9
	Low	7	6

SD			
Format vidéo	Paramètre Bit Rate	Débit (Mb/s) H.264	Débit (Mb/s) H.264
625i50	High	18	11
	Medium	12	8
	Low	6	6
525i59.94	High	20	12
	Medium	14	9
	Low	7	6

Paramètre Trigger

Le paramètre Trigger active le déclenchement de l'enregistrement. Ce paramètre permet de démarrer ou d'arrêter l'enregistrement du Blackmagic Duplicator 4K lorsque vous appuyez sur le bouton d'enregistrement d'un appareil SDI (par exemple la URSA Mini).

None

Sélectionnez none pour désactiver la fonction Trigger.

SDI Start/Stop

Quand l'option SDI Start/Stop est activée, le Blackmagic Duplicator 4K démarre l'enregistrement lorsque vous appuyez sur le bouton d'enregistrement d'un appareil SDI.

Par exemple, Blackmagic URSA Mini envoie un signal d'enregistrement via sa sortie SDI, ainsi, lorsque vous appuyez sur le bouton d'enregistrement de la caméra, le Blackmagic Duplicator 4K démarre également l'enregistrement. L'enregistrement s'interrompt lorsque vous appuyez de nouveau sur ce bouton. Il n'est pas nécessaire de régler ce paramètre sur la URSA Mini pour activer le déclenchement de l'enregistrement. Cependant, si vous utilisez d'autres appareils SDI qui prennent en charge cette fonction et que vous souhaitez les utiliser pour déclencher l'enregistrement, veillez à activer cette fonction dans les paramètres de l'appareil.

Timecode Run

Si l'appareil SDI ne prend pas en charge la fonction de déclenchement de l'enregistrement, réglez le Blackmagic Video Assist pour qu'il démarre l'enregistrement dès qu'il détecte un timecode actif. Par exemple, si une caméra SDI réglée sur **Record run** est connectée au Blackmagic Duplicator 4K, ce réglage déclenchera aussi l'enregistrement du Blackmagic Duplicator 4K. Lorsque vous arrêtez l'enregistrement sur la caméra, le timecode s'interrompt et entraîne l'interruption de l'enregistrement du Blackmagic Duplicator 4K.

Cette fonction est extrêmement pratique, mais veuillez vous assurer que le paramètre de timecode de l'appareil est réglé sur record run. Si le paramètre du timecode est réglé sur time of the day, la caméra acheminera alors continuellement du timecode et entraînera un enregistrement continu sur le Blackmagic Duplicator 4K.

Formatage des cartes

Vous pouvez formater jusqu'à 25 cartes simultanément à l'aide de la fonction de formatage du Blackmagic Duplicator 4K.

Pour formater vos cartes :

- 1 Appuyez sur le bouton **MENU** du panneau de contrôle pour ouvrir le menu à l'écran.
- 2 Appuyez sur le bouton multifonction record pour ouvrir les paramètres d'enregistrement.
- 3 Appuyez sur les flèches gauche et droite pour accéder au paramètre format cards et appuyez sur format.
- 4 Un message apparaît et vous demande de confirmer le formatage. Un message d'avertissement vous informe que cette action est irréversible. Si vos cartes contiennent des données que vous souhaitez sauvegarder, assurez-vous de les sauvegarder sur un autre support avant de les formater.
- 5 Appuyez sur le bouton format pour confirmer cette action. Vous pouvez également appuyer sur le bouton cancel pour revenir aux paramètres record.
- 6 Lorsque vos cartes sont en cours de formatage, un voyant jaune clignotant et une barre de progression apparaissent à l'écran. Lorsque les cartes sont formatées, un voyant vert s'allume et le menu à l'écran affiche que le formatage est terminé. Vos cartes sont désormais prêtes pour l'enregistrement.
- 7 Appuyez sur **Ok**. Appuyez sur le bouton **Menu** du panneau de contrôle pour revenir au menu principal.

Menu Settings

Le menu settings permet de régler les paramètres réseau du Blackmagic Duplicator 4K, tels que l'activation et la désactivation du protocole DHCP, le réglage de l'adresse IP, du masque de sous-réseau et de la passerelle. Connecter le Blackmagic Duplicator 4K à un réseau vous permet de contrôler l'appareil à distance à l'aide d'un logiciel de gestion tiers, tel que Telnet.

DHCP On

Pour définir les paramètres optimaux du Blackmagic Duplicator 4K lorsque vous le connectez au réseau, sélectionnez **On**. Le Blackmagic Duplicator 4K vérifie alors tous les appareils connectés au réseau et configure l'adresse IP et les autres paramètres réseau pour éviter des conflits de paramétrage. Cette option est très fiable et permet de configurer facilement les paramètres réseau.

DHCP Off

Si vous souhaitez conserver un contrôle manuel sur tous les paramètres réseau, sélectionner **Off**. Vous pourrez ensuite régler l'adresse IP, le masque de sous-réseau et la passerelle.

Paramètres IP Address, Subnet Mask et Gateway

Lorsque le protocole DHCP est réglé sur **Off**, vous pouvez modifier manuellement ces paramètres.

Pour modifier les valeurs numériques :

- 1 Sélectionnez le champ que vous souhaitez modifier à l'aide des boutons multifonctions gauche et droit et appuyez sur change.
- 2 Appuyez sur les boutons multifonctions gauche et droit pour augmenter ou diminuer les valeurs numériques. Vous pouvez maintenir les boutons multifonctions enfoncés pour accélérer le défilement des valeurs.
- 3 Appuyez sur set pour confirmer le changement.

Vous pouvez désormais appuyer sur les boutons multifonctions pour régler les autres champs.



Le menu settings vous permet de modifier les paramètres réseau afin de contrôler le Blackmagic Duplicator 4K à l'aide d'un logiciel de gestion tiers, tel que Telnet.

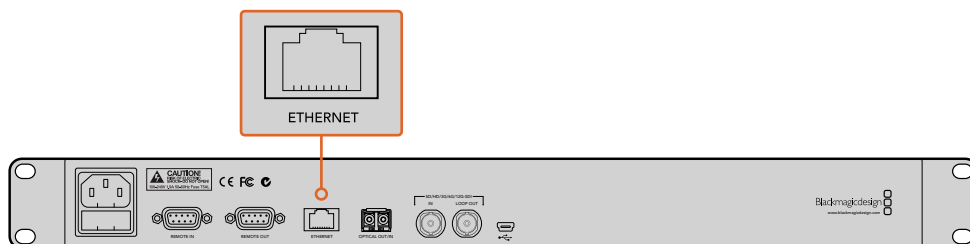

Connectez le Blackmagic Duplicator 4K au réseau via le port Ethernet situé sur la face arrière de l'appareil.

Paramètres About

Ce paramètre offre un aperçu instantané du débit utilisé, le nom de fichier de votre dernier enregistrement, l'état du réseau et la version du logiciel interne de votre Blackmagic Duplicator 4K.

Logiciel Blackmagic Duplicator Utility

Mettre à jour votre Blackmagic Duplicator 4K

Le logiciel Blackmagic Duplicator Utility permet de mettre à jour le logiciel interne du Blackmagic Duplicator 4K et de modifier le paramètre **File Name Prefix** afin d'ajouter des libellés à vos enregistrements. Nous vous recommandons de télécharger le logiciel et de mettre à jour votre Blackmagic Duplicator 4K afin de bénéficier des fonctions les plus récentes et de toutes les améliorations disponibles.

Téléchargez la dernière version du logiciel sur la page d'assistance de Blackmagic Design www.blackmagicdesign.com/fr/support.

Pour mettre à jour le logiciel interne avec macOS :

- 1 Téléchargez et dézippez Blackmagic Duplicator Utility.
- 2 Ouvrez le logiciel et lancez le programme d'installation Blackmagic Duplicator Utility. Suivez les instructions à l'écran.
- 3 Après avoir installé la dernière version du Blackmagic Duplicator Utility, connectez le Blackmagic Duplicator 4K à votre ordinateur à l'aide d'un câble USB.
- 4 Lancez le Blackmagic Duplicator Utility et ouvrez les paramètres en cliquant sur l'icône circulaire. Si le logiciel détecte une version antérieure, une icône update now s'affiche. Cliquez simplement sur cette icône pour mettre à jour le logiciel interne. Si le logiciel interne du Blackmagic Duplicator 4K est à jour, la mise à jour est terminée.

Pour mettre à jour le logiciel interne avec Windows :

- 1 Téléchargez et dézippez Blackmagic Duplicator Utility.
- 2 Un dossier Blackmagic Duplicator Utility s'affiche, il contient le manuel et le programme d'installation Blackmagic Duplicator Utility. Double-cliquez sur le programme d'installation et suivez les instructions à l'écran pour terminer l'installation.
- 3 Après avoir installé la dernière version du Blackmagic Duplicator Utility, connectez le Blackmagic Duplicator 4K à votre ordinateur à l'aide d'un câble USB.
- 4 Lancez le Blackmagic Duplicator Utility et ouvrez les paramètres en cliquant sur l'icône circulaire. Si le logiciel détecte une version antérieure, une icône update now s'affiche. Cliquez simplement sur cette icône pour mettre à jour le logiciel interne. Si le logiciel interne du Blackmagic Duplicator 4K est à jour, la mise à jour est terminée.

Nommer les fichiers

Vous pouvez modifier le nom des fichiers afin de pouvoir facilement les identifier. Pour ce faire, il suffit de cliquer dans la zone de texte **File Name Prefix** et de saisir un nouveau nom. Lorsque le Blackmagic Duplicator 4K enregistre le clip suivant, le nom du fichier apparaît avec un nom personnalisé suivi de quatre chiffres permettant d'identifier le numéro du clip. Ces chiffres augmentent à chaque fois qu'un clip est enregistré.

Vous pouvez également faire en sorte que les enregistrements effectués sur les appareils reliés en chaîne utilisent le même nom de fichier en activant le bouton Remote des appareils esclaves, puis en modifiant le paramètre **File Name Prefix** sur l'appareil maître. Cela vous permet d'enregistrer des clips et d'obtenir le même nom de fichier sur toutes les cartes insérées dans les appareils.

Installation d'un module Optical Fiber SDI Module en option

Si vous souhaitez brancher un signal SDI sur fibre optique, il vous faudra installer un module Optical Fiber SDI Module en option. Tout type de module SFP fibre optique compatible et conforme aux normes de la SMPTE peut être installé. Ce produit est vendu séparément auprès des revendeurs Blackmagic Design. Insérez-le simplement dans le logement fibre optique situé sur la face arrière du Blackmagic Duplicator 4K. Si le module Optical Fiber SDI Module est installé, vous pouvez acheminer de la vidéo SDI avec audio intégré sur de longues distances. Vous pouvez également utiliser la sortie fibre optique pour ajouter un connecteur vidéo en boucle.

Si vous utilisez des systèmes fibre optique ayant des débits moins élevés tels que la fibre optique 3G-SDI ou 6G-SDI, vous pouvez installer un module moins performant par mesure d'économie.

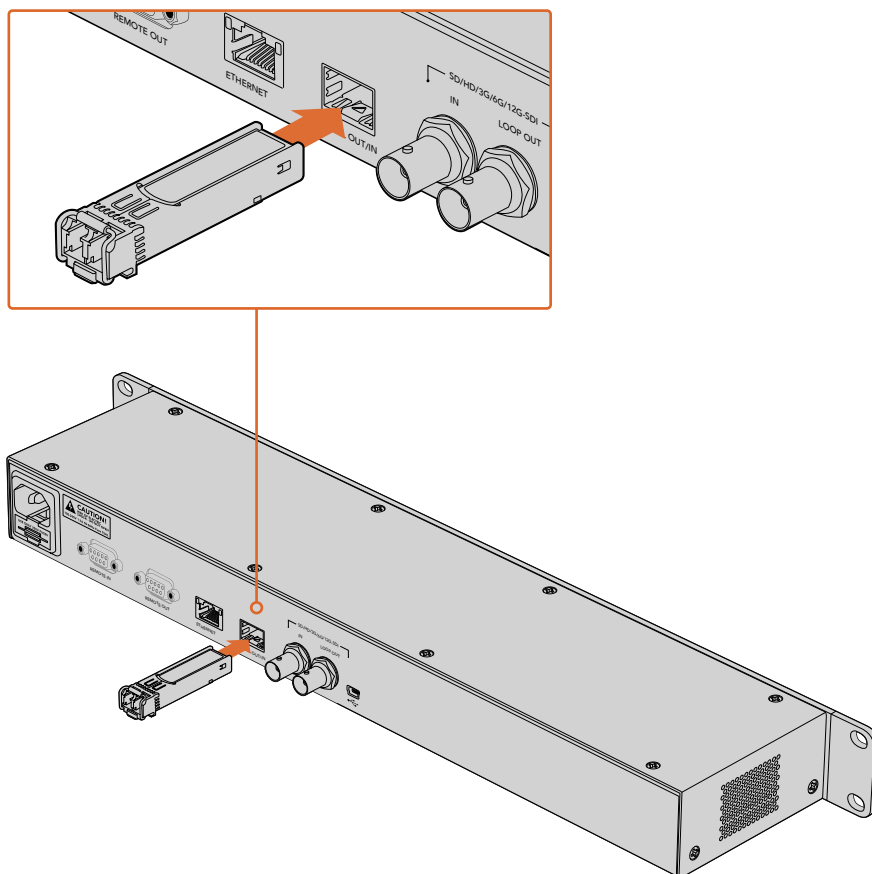

Installez un module Optical Fiber SDI Module en option pour connecter de la vidéo SDI sur fibre optique.

Le Blackmagic Duplicator 4K utilise le premier connecteur vidéo branché. Cependant, si les connecteurs SDI et fibre optique sont tous les deux connectés, vous pouvez sélectionner le signal que vous souhaitez utiliser dans le paramètre video source du menu **Record**. Pour plus d'information, consultez la section « Paramètres Settings » de ce manuel.

Port RS-422

Qu'est-ce que le contrôle RS-422 ?

Le standard RS-422 est un contrôle de périphérique série utilisé par les diffuseurs depuis le début des années 1980 pour les enregistreurs, les solutions de montage linéaires et non linéaires et les produits broadcast automatisés. Le Blackmagic Duplicator 4K prend en charge ce standard afin d'être intégré dans des systèmes broadcast automatisés, des systèmes de contrôle à distance, des systèmes d'enregistrement automatisés ou tout autre contrôle personnalisé que vous souhaitez utiliser.

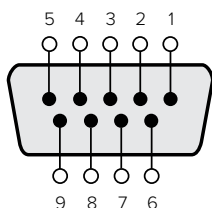

Transmission (-)	Transmission (+)	Réception (-)	Réception (+)	Terre
2	7	8	3	1, 4, 6, 9

Broches de la sortie RS-422.

Utilisation d'un contrôleur RS-422 externe

Le Blackmagic Duplicator 4K dispose d'un port RS-422 Sony™ standard, qui offre les connexions adéquates au contrôle à distance.

Vous pouvez utiliser des câbles à 9 broches standard dotés d'un nombre équivalent de broches à chaque extrémité. Si votre matériel est relié à l'aide de câbles personnalisés, veuillez consulter le schéma de câblage afin de vous assurer que les broches de transmission (Tx) sont correctement reliées aux broches réceptrices (Rx).

En connectant un contrôleur RS-422 externe au Blackmagic Duplicator 4K, vous pouvez le contrôler à distance sans utiliser les boutons.

- 1 Connectez un contrôleur RS-422 externe à l'entrée de contrôle à distance du Blackmagic Duplicator 4K afin de contrôler l'unité à distance.
- 2 Appuyez sur le bouton de contrôle à distance **REM** du panneau de contrôle du Blackmagic Duplicator 4K pour activer le contrôle à distance.

Vous pouvez désormais démarrer et arrêter l'enregistrement ou démarrer et arrêter l'ajout d'un enregistrement à un fichier existant, le tout à distance. La liste complète des commandes RS-422 prises en charge est affichée dans le tableau Commandes RS-422 prises en charge ci-dessous.

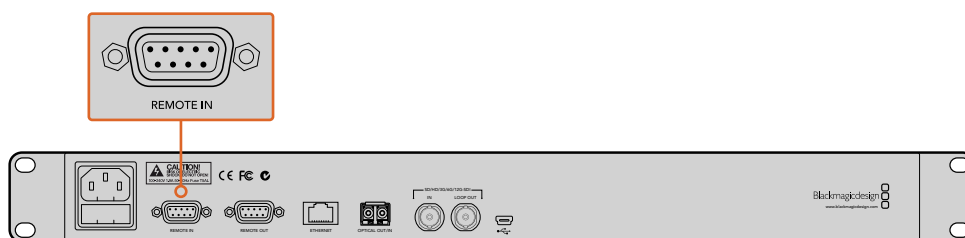

Connectez un contrôleur RS-422 externe à l'entrée de contrôle à distance du Blackmagic Duplicator 4K pour contrôler l'unité à distance.

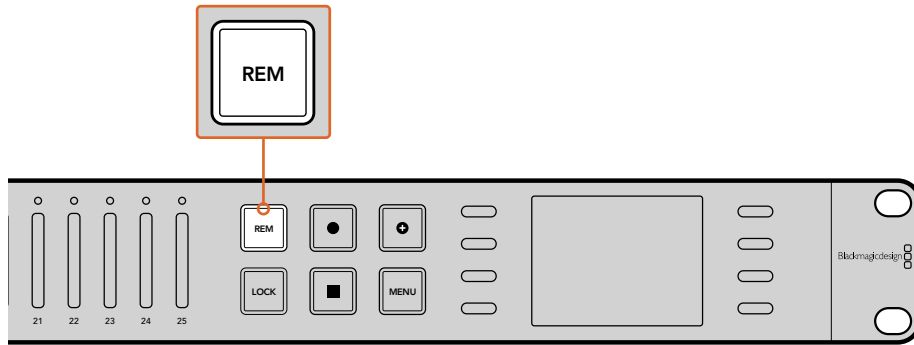

Appuyez sur le bouton de contrôle à distance du Blackmagic Duplicator 4K pour activer le contrôle à distance.

Commandes RS-422 prises en charge

Command			Reply	No Remote	Notes
0 - System Control					
0x00	0x11	DeviceTypeRequest	NTSC: 0xF0E0 PAL: 0xF1E0 24P: 0xF2E0	Enabled	

1 - Slave Response					
0x20	0x00	Stop	Acknowledge	Disabled	
0x20	0x02	Record	Acknowledge	Disabled	
0x21	0x02	Append	Acknowledge	Disabled	Non-standard command - an extra payload of 0x00 indicates append

4 - Preset/Select Control					
0x40	0x40	AutoMode Off	Acknowledge	Disabled	ignored, Status bit remembered
0x40	0x41	AutoMode On	Acknowledge	Disabled	ignored, Status bit remembered
0x61	0x20	StatusSense	StatusData	Enabled	

7 - Sense Reply					
0x70	0x20	StatusData	-	-	Please see "Status Bits" sheet: Limited to 9 bytes of status, silently truncated

RS-422 Developer Information

	Bit 7	Bit 6	Bit 5	Bit 4	Bit 3	Bit 2	Bit 1	Bit 0
Byte 0	0	0	Cassette out	0	0	0	0	Local
Byte 1	Standby	0	Stop	0	0	0	Record	0
Byte 2	0	0	0	0	0	0	0	0
Byte 3	Auto Mode	0	0	0	0	0	0	0
Byte 4	Select EE	Full EE	0	0	0	0	0	0
Byte 5	0	0	0	0	0	0	0	0
Byte 6	0	0	0	0	0	0	0	0
Byte 7	0	0	0	0	0	0	0	0
Byte 8	0	0	0	0	0	0	0	0
Byte 9	0	0	0	0	0	0	0	0

Variables	
Cassette Out	Set if no cards are ready to record
Local	Set if in local mode (no remote control)
Standby	Set if one or more cards are ready to record
Auto Mode	For compatibility only
Full EE	For compatibility only - always on
Select EE	For compatibility only - always on

Blackmagic Duplicator 4K RS-422 Settings	
Protocol	Based on Sony 9-pin protocol
Baud Rate	38.4 K
Start Bits	1
Data Bits	8
Stop Bits	1
Parity Bits	1
Parity Type	Odd

Contrôle à distance via Ethernet

Le Blackmagic Duplicator 4K peut être contrôlé de façon externe à l'aide des commandes textuelles du protocole Ethernet. Cela vous permet de contrôler votre Blackmagic Duplicator 4K à distance à l'aide d'un logiciel de gestion tel que Telnet, installé sur un ordinateur. Vous pouvez également personnaliser votre propre panneau de contrôle matériel et le programmer pour contrôler le Blackmagic Duplicator 4K à l'aide du protocole Ethernet HyperDeck.

Si vous le souhaitez, vous pouvez développer votre propre solution de contrôle à partir d'un ordinateur, d'un appareil ou d'un système de contrôle matériel dédié installé en régie ou dans un camion régie. Par exemple, les microcontrôleurs Arduino sont de petites cartes de circuit imprimé sur lesquelles peuvent être ajoutées des cartes expansion « Shield ». Il existe plusieurs types de cartes Shield qui comprennent chacune différents connecteurs. Pour contrôler le Blackmagic Duplicator 4K, une carte Ethernet Shield est requise. Vous pouvez également acheter des cartes Shield supplémentaires dotées de boutons programmables ! Les microcontrôleurs de Arduino s'installent facilement, ne coûtent pas cher et disposent d'un code source ouvert. Une fois le logiciel Arduino programmé, vous pouvez simplement connecter la carte au port Ethernet du Blackmagic Duplicator 4K et commencer à contrôler l'appareil immédiatement.

Exemple de contrôle via un microcontrôleur Arduino

Les microcontrôleurs Arduino sont programmés en langage C. Programmez simplement le contrôleur afin qu'il envoie des commandes au Blackmagic Duplicator 4K via le protocole Ethernet HyperDeck. Les commandes prises en charge sont indiquées dans la section « Protocole Ethernet Blackmagic HyperDeck ».

Vous pouvez ajouter d'autres cartes Shield au microcontrôleur Arduino afin d'intégrer d'autres fonctions d'enregistrement. Par exemple, si vous ajoutez une horloge interne, vous pouvez programmer le contrôleur pour qu'il envoie une commande d'enregistrement à certaines heures de la journée au Blackmagic Duplicator 4K. Cette fonction est particulièrement utile pour enregistrer de la vidéo surveillance.

Nous sommes très heureux de pouvoir proposer cette technologie et nous avons hâte de découvrir les contrôleurs Ethernet externes que vous avez conçus.

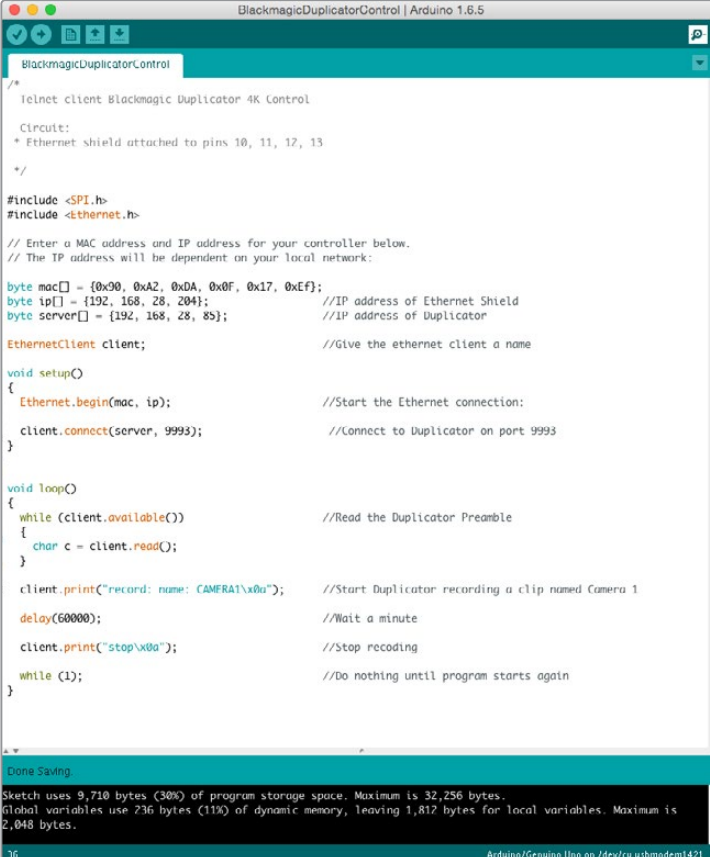

```
BlackmagicDuplicatorControl | Arduino 1.6.5
BlackmagicDuplicatorControl
/*
 * Telnet client Blackmagic Duplicator 4K Control
 *
 * Circuit:
 * Ethernet shield attached to pins 10, 11, 12, 13
 */
#include <SPI.h>
#include <Ethernet.h>

// Enter a MAC address and IP address for your controller below.
// The IP address will be dependent on your local network:

byte mac[] = {0x90, 0xA2, 0xDA, 0x0F, 0x17, 0xEF}; //IP address of Ethernet Shield
byte ip[] = {192, 168, 28, 204}; //IP address of Duplicator
byte server[] = {192, 168, 28, 85};

EthernetClient client; //Give the ethernet client a name

void setup()
{
  Ethernet.begin(mac, ip); //Start the Ethernet connection:
  client.connect(server, 9993); //Connect to Duplicator on port 9993
}

void loop()
{
  while (client.available()) //Read the Duplicator Preamble
  {
    char c = client.read();
  }

  client.print("record: name: CAMERA1\r\n"); //Start Duplicator recording a clip named Camera 1
  delay(60000); //Wait a minute
  client.print("stop\r\n"); //Stop recording
  while (1); //Do nothing until program starts again
}
```

Done Saving

Sketch uses 9,710 bytes (30%) of program storage space. Maximum is 32,256 bytes.
Global variables use 236 bytes (11%) of dynamic memory, leaving 1,812 bytes for local variables. Maximum is 2,048 bytes.

36 Arduino/Genuino Uno on /dev/cu.usbmodem1421

Lorsque vous programmez un contrôleur Ethernet externe, utilisez simplement les commandes du protocole Ethernet indiquées ci-dessus pour contrôler votre appareil.

Le code indiqué dans la fenêtre ci-dessus apparaît également à la page suivante pour que vous puissiez copier et coller les commandes dans votre environnement de développement Arduino. Le code programme alors le microcontrôleur Arduino pour qu'il envoie des commandes au Blackmagic Duplicator 4K. Les instructions affichées sont les suivantes : enregistrement pendant une minute, arrêt de l'enregistrement et mise en attente jusqu'à ce que le programme envoie une autre commande.

```

/*
   Telnet client Blackmagic Duplicator 4K Control Circuit: *
Ethernet shield attached to pins 10, 11, 12, 13
*/
#include <SPI.h>
#include <Ethernet.h>

// Enter a MAC address and IP address for your controller below.
// The IP address will be dependent on your local network:
byte mac[] = {0x90, 0xA2, 0xDA, 0x0F, 0x17, 0xEF};
byte ip[] = {192, 168, 28, 204};           // IP address of
Ethernet Shield
byte server[] = {192, 168, 28, 141};      // IP address of Duplicator
EthernetClient client;                   // Give the ethernet
client a name

void setup()
{
  Ethernet.begin(mac, ip);    //Start the Ethernet connection:

  client.connect(server, 9993); //Connect to Duplicator on port 9993
}

void loop()
{
  while (client.available()) //Read the Duplicator Preamble
  {
    char c = client.read();
  }

  client.print("record: name: Camera1\x0a");
//Start Duplicator recording a clip named Camera 1
  delay(60000); //Wait a minute
  client.print("stop\x0a"); //Stop recoding
  while (1); //Do nothing until program
starts again
}

```

Protocole Ethernet Blackmagic HyperDeck

Le protocole Ethernet Blackmagic HyperDeck est un protocole textuel initialement écrit pour contrôler le port Ethernet intégré aux modèles HyperDeck Studio. Il peut, cependant, être utilisé pour contrôler le Blackmagic Duplicator 4K.

Comme le duplicateur est uniquement destiné à l'enregistrement, ce protocole ne comprend pas la totalité des commandes. Cette section indique uniquement les commandes disponibles lors de l'utilisation du protocole Ethernet HyperDeck avec le Blackmagic Duplicator 4K.

Protocol Commands

Command	Command Description
help or ?	Provides help text with all commands and parameters.
remote	Queries the state of HyperDeck's remote control mode.
remote: enable: true	Enables remote control.
remote: enable: false	Disables remote control.
remote: override: true	Turns remote override on.
remote: override: false	Turns remote override off.
quit	Disconnects HyperDeck server.
ping	Determines HyperDeck server is responding.
record	Starts recording.
record: append: true	Starts appended recording.
stop	Stops playback or recording.
commands	Lists all supported commands in an XML format.
notify	Queries the current state of all notifications.
notify: transport: true	Enables transport notifications.
notify: transport: false	Disables transport notifications.
notify: slot: true	Enables slot notifications.
notify: slot: false	Disables slot notifications.
notify: remote: true	Enables remote notifications.
notify: remote: false	Disables remote notifications.
notify: configuration: true	Enables configuration notifications.
notify: configuration: false	Disables configuration notifications.
notify: dropped frames: true	Enables dropped frames notifications.
notify: dropped frames: false	Disables dropped frames notifications.
device info	Provides device information.
slot info: slot id: {slot ID}	Provides information about a specified slot.
transport info	Provides information for the state of the transport.
configuration	Queries the current configuration.
configuration: record mode: Duplicate	Configures the record mode to duplicate.

Command	Command Description
configuration: record mode: SingleDisk	Configures the record mode to single disk.
configuration: record mode: DiskOverwrite	Configures the record mode to disk overwrite.
configuration: video input: {"SDI", "optical"}	Configures video input.
configuration: file format: {format}	Configures the record codec and bit rate.
format: prepare: {format}	prepare a disk formatting operation to filesystem {format}
format: confirm: {token}	perform a pre-prepared formatting operation using token
watchdog: period: {seconds}	Configures the watchdog.

Using XML

While you can use the Terminal to talk to HyperDeck, if you are writing software you can use XML to confirm the existence of a specific command based on the firmware of the HyperDeck you are communicating with. This helps your software user interface adjust to the capabilities of the specific HyperDeck model and software version.

Protocol Details

Connection

The HyperDeck Ethernet server listens on TCP port 9993.

Basic syntax

The HyperDeck protocol is a line oriented text protocol. Lines from the server will be separated by an ascii CR LF sequence. Messages from the client may be separated by LF or CR LF.

New lines are represented in this document as a "↵" symbol.

Command syntax

Command parameters are usually optional. A command with no parameters is terminated with a new line:

```
{Command name}↵
```

If parameters are specified, the command name is followed by a colon, then pairs of parameter names and values. Each parameter name is terminated with a colon character:

```
{Command name}: {Parameter}: {Value} {Parameter}: {Value} ...↵
```

Response syntax

Simple responses from the server consist of a three digit response code and descriptive text terminated by a new line:

```
{Response code} {Response text}↵
```

If a response carries parameters, the response text is terminated with a colon, and parameter name and value pairs follow on subsequent lines until a blank line is returned:

```
{Response code} {Response text}:↵
{Parameter}: {Value}↵
{Parameter}: {Value}↵
...
↵
```

Successful response codes

A simple acknowledgement of a command is indicated with a response code of 200:

```
200 ok↵
```

Other successful responses carry parameters and are indicated with response codes in the range of 201 to 299.

Failure response codes

Failure responses to commands are indicated with response codes in the range of 100 to 199:

```
100 syntax error
101 unsupported parameter
102 invalid value
103 unsupported
104 disk full
105 no disk
106 disk error
109 out of range
110 no input
111 remote control disabled
120 connection rejected
150 invalid state
```

Asynchronous response codes

The server may return asynchronous messages at any time. These responses are indicated with response codes in the range of 500 to 599:

```
5xx {Response Text}:↵
{Parameter}: {Value}↵
{Parameter}: {Value}↵
↵
```

Connection response

On connection, an asynchronous message will be delivered:

```
500 connection info:↵
protocol version: {Version}↵
model: {Model Name}↵
↵
```

Connection rejection

Only one client may connect to the server at a time. If other clients attempt to connect concurrently, they will receive an error and be disconnected:

```
120 connection rejected↵
```

Timecode syntax

Timecodes are expressed as non-drop-frame timecode in the format:

```
HH:MM:SS:FF
```

Handling of deck "remote" state

The "remote" command may be used to enable or disable the remote control of the deck. Any attempt to change the deck state over ethernet while remote access is disabled will generate an error:

```
111 remote control disabled↵
```

To enable or disable remote control:

```
remote: enable: {"true", "false"} ↵
```

The current remote control state may be overridden allowing remote access over ethernet irrespective of the current remote control state:

```
remote: override: {"true", "false"} ↵
```

The override state is only valid for the currently connected ethernet client and only while the connection remains open.

The "remote" command may be used to query the remote control state of the deck by specifying no parameters:

```
remote↵
```

The deck will return the current remote control state:

```
210 remote info:↵
enabled: {"true", "false"}↵
override: {"true", "false"}↵
↵
```

Asynchronous remote control information change notification is disabled by default and may be configured with the "notify" command. When enabled, changes in remote state will generate a "510 remote info:" asynchronous message with the same parameters as the "210 remote info:" message.

Closing connection

The "quit" command instructs the server to cleanly shut down the connection:

```
quit↵
```

Checking connection status

The "ping" command has no function other than to determine if the server is responding:

```
ping↵
```

Getting help

The "help" or "?" commands return human readable help text describing all available commands and parameters:

```
help↵
```

or:

```
?↵
```

The server will respond with a list of all supported commands:

```
201 help:↵
{Help Text}↵
{Help Text}↵
↵
```

Stopping deck operation

The "stop" command instructs the deck to stop the current capture:

```
stop↵
```

Enumerating supported commands and parameters

The "commands" command returns the supported commands:

```
commands↵
```

The command list is returned in a computer readable XML format:

```
212 commands:
<commands>↵
    <command name="..."><parameter name="..."/>...</command>↵
    <command name="..."><parameter name="..."/>...</command>↵
    ...
</commands>↵
↵
```

More XML tokens and parameters may be added in later releases.

Controlling asynchronous notifications

The "notify" command may be used to enable or disable asynchronous notifications from the server. To enable or disable transport notifications:

```
notify: transport: {"true", "false"}↵
```

To enable or disable slot notifications:

```
notify: slot: {"true", "false"}↵
```

To enable or disable remote notifications:

```
notify: remote: {"true", "false"}↵
```

To enable or disable configuration notifications:

```
notify: configuration: {"true", "false"}↵
```

To enable or disable dropped frames notifications:

```
notify: dropped frames: {"true", "false"}↵
```

Multiple parameters may be specified. If no parameters are specified, the server returns the current state of all notifications:

```
209 notify:↵
transport: {"true", "false"}↵
slot: {"true", "false"}↵
remote: {"true", "false"}↵
configuration: {"true", "false"}↵
↵
```

Retrieving device information

The "device info" command returns information about the connected deck device:

```
device info↵
```

The server will respond with:

```
204 device info:↵
protocol version: {Version}↵
model: {Model Name}↵
unique id: {unique alphanumeric identifier}↵
↵
```

Example of response from server:

```
204 device info:↵
protocol version: 1.8↵
model: Blackmagic Duplicator 4K↵
unique id: 101112131415↵
↵
```

Retrieving slot information

The "slot info" command returns information about a slot.

The specified slot will be queried:

```
slot info: slot id: {Slot ID}↵
```

The server will respond with slot specific information:

```
202 slot info:↵
slot id: {Slot ID}↵
status: {"empty", "mounting", "error", "mounted"}↵
volume name: {Volume name}↵
recording time: {recording time available in seconds}↵
video format: {disk's default video format}↵
↵
```

Asynchronous slot information change notification is disabled by default and may be configured with the “notify” command. When enabled, changes in slot state will generate a “502 slot info:” asynchronous message with the same parameters as the “202 slot info:” message.

Retrieving transport information

The “transport info” command returns the state of the transport:

```
transport info ↵
```

The server responds with transport specific information:

```
208 transport info:↵  
status: {"stopped","record"}↵  
display timecode: {timecode}↵  
timecode: {timecode}↵
```

The “timecode” value is the timecode within the current timeline for playback or the clip for record. The “display timecode” is the timecode displayed on the front of the deck. The two timecodes will differ in some deck modes.

Asynchronous transport information change notification is disabled by default and may be configured with the “notify” command. When enabled, changes in transport state will generate a “508 transport info:” asynchronous message with the same parameters as the “208 transport info:” message.

Video Formats

The following video formats are currently supported on Blackmagic Duplicator 4K:

SD

525i59.94 NTSC
625i50 PAL

HD

720p50	1080p30
720p59.94	1080i50
720p60	1080p50
1080p23.98	1080i59.94
1080p24	1080p59.94
1080p25	1080i60
1080p29.97	1080p60

Ultra HD

2160p23.98	2160p30
2160p24	2160p50
2160p25	2160p59.94
2160p29.97	2160p60

Duplicator 4K supports progressive segmented frame modes, and automatically detects level A and level B 3G-SDI formats for 1080p50, 1080p59.94 and 1080p60.

File Formats

Duplicator 4K supports the following file formats:

- H.264Low
- H.264Medium
- H.264High
- H.265Low
- H.265Medium
- H.265High

Querying and updating configuration information

The "configuration" command may be used to query the current configuration of the deck:

```
configuration↵
```

The server returns the configuration of the deck:

```
211 configuration:↵  
video input: {"SDI", "optical"}↵  
↵
```

One or more configuration parameters may be specified to change the configuration of the deck.

To change the current video input:

```
configuration: video input: {"SDI", "optical"}↵
```

Configuring the watchdog

The "watchdog" command instructs the deck to monitor the connected client and terminate the connection if the client is inactive for at least a specified period of time.

To configure the watchdog:

```
watchdog: period: {period in seconds}↵
```

To avoid disconnection, the client must send a command to the server at least every {period} seconds. Note that if the period is set to 0 or less than 0, connection monitoring will be disabled.

Configuring the record mode

Use the 'record mode' command to select the deck recording mode:

```
configuration: record mode: {"Duplicate", "SingleDisk", "DiskOverwrite"}↵
```

Configuring the file format

The 'file format' command instructs the deck to switch to a specific file format for codec and bit rate:

```
configuration: file format: {"H.264High", "H.264Medium", "H.264Low",  
"H.265High", "H.265Medium", "H.265Low"}↵
```

Assistance

Obtenir de l'aide

Le moyen le plus rapide d'obtenir de l'aide est de consulter les pages d'assistance en ligne de Blackmagic Design et de consulter les informations les plus récentes concernant le Blackmagic Duplicator 4K.

Pages d'assistance en ligne de Blackmagic Design

Les dernières versions du manuel, du logiciel et des notes d'assistance peuvent être consultées sur la page d'assistance technique de Blackmagic Design : www.blackmagicdesign.com/fr/support.

Forum Blackmagic Design

Le forum Blackmagic Design est une source d'information utile qui offre des idées innovantes pour vos productions. Cette plate-forme d'aide vous permettra également d'obtenir des réponses rapides à vos questions, car un grand nombre de sujets peuvent déjà avoir été abordés par d'autres utilisateurs. Pour vous rendre sur le forum : <http://forum.blackmagicdesign.com>

Contacter le service d'assistance de Blackmagic Design

Si vous ne parvenez pas à trouver l'aide dont vous avez besoin dans les pages d'assistance ou sur notre forum, veuillez utiliser l'option « Envoyez-nous un email », accessible sur la page d'assistance pour envoyer une demande d'aide par email. Vous pouvez également cliquer sur le bouton « Trouver un support technique » situé sur la page d'assistance et contacter ainsi le centre d'assistance technique Blackmagic Design le plus proche de chez vous.

Vérification du logiciel actuel

Pour vérifier quelle version du logiciel Blackmagic Duplicator Utility est installée sur votre ordinateur, ouvrez la fenêtre intitulée About Blackmagic Duplicator Utility.

- Sur macOS, ouvrez le Blackmagic Duplicator Utility à partir du dossier Applications. Sélectionnez About Blackmagic Duplicator Utility dans le menu d'application pour connaître le numéro de version.
- Sur Windows 8.1, ouvrez Blackmagic Duplicator Utility dans la vignette Blackmagic Duplicator Utility de la page d'accueil. Cliquez sur le menu Aide et sélectionnez About Blackmagic Duplicator Utility pour connaître le numéro de version.
- Sur Windows 10, ouvrez le logiciel Blackmagic Duplicator Utility dans votre menu de Démarrage. Cliquez sur le menu Aide et sélectionnez About Blackmagic Duplicator Utility pour connaître le numéro de version.

Comment obtenir les dernières mises à jour du logiciel

Après avoir vérifié quelle version du logiciel Blackmagic Duplicator Utility est installée sur votre ordinateur, veuillez vous rendre sur la page d'assistance technique Blackmagic Design à l'adresse suivante www.blackmagicdesign.com/fr/support pour vérifier les dernières mises à jour. Même s'il est généralement conseillé d'installer les dernières mises à jour, il est prudent d'éviter d'effectuer ces mises à jour au milieu d'un projet important.

Avis réglementaires et informations de sécurité

Avertissements

Élimination des déchets d'équipements électriques et électroniques au sein de l'Union européenne.



Le symbole imprimé sur ce produit indique qu'il ne doit pas être jeté avec les autres déchets. Cet appareil doit être déposé dans un point de collecte agréé pour être recyclé. La collecte individuelle et le recyclage de votre équipement permettra de préserver les ressources naturelles et garantit un recyclage approprié afin d'éviter la contamination de l'environnement par des substances dangereuses pour la santé. Pour plus d'informations quant aux lieux d'éliminations des déchets d'équipements électriques, vous pouvez contacter votre mairie ou le service local de traitement des ordures ménagères.



Cet équipement a été testé et déclaré conforme aux limites imposées aux appareils numériques de classe A, en vertu du chapitre 15 des règles de la FCC. Ces limites ont pour objectif d'assurer une protection suffisante contre les interférences nuisibles lorsque l'équipement est utilisé dans un environnement commercial. Cet appareil génère, utilise et émet de l'énergie de fréquences radio et peut, en cas d'installation ou d'utilisation non conforme aux instructions, engendrer des interférences nuisibles au niveau des communications radio. L'utilisation de cet équipement en zone résidentielle est susceptible de provoquer des interférences nuisibles, auquel cas il sera demandé à l'utilisateur de corriger ces interférences à ses frais.

L'utilisation de cet appareil est soumise aux deux conditions suivantes :

- 1 Cet appareil ne peut causer d'interférences nuisibles.
- 2 Cet appareil doit accepter toute interférence reçue, notamment celles pouvant entraîner un dysfonctionnement.

Déclaration de ISDE Canada

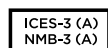

Cet appareil est conforme aux normes canadiennes relatives aux appareils numériques de Classe A.

Toute modification ou utilisation de ce produit en dehors de son utilisation prévue peut annuler la conformité avec ces normes.

Cet équipement a été testé pour être en conformité avec une utilisation prévue dans un environnement commercial. Si cet équipement est utilisé dans un environnement domestique, il peut provoquer des interférences radio.

Informations de sécurité

Pour une protection contre les décharges électriques, cet appareil doit être connecté à une prise secteur équipée d'un conducteur de protection. En cas de doute, veuillez contacter un électricien qualifié.

Afin de réduire le risque de décharge électrique, ne pas éclabousser ou renverser de liquide sur cet appareil.

Ce produit peut être utilisé dans un climat tropical lorsque la température ambiante n'excède pas 40°C.

Veillez à ce que l'espace autour du produit soit suffisant afin de ne pas compromettre la ventilation.

Lorsque vous installez l'appareil sur rack, veillez à ce que la ventilation ne soit pas compromise par les autres équipements.

Les pièces de cet appareil ne sont pas réparables par l'opérateur. Toute opération d'entretien doit être effectuée par un centre de service Blackmagic Design.

Vous pouvez connecter des modules SFP fibre optique à certains produits. Utilisez seulement des modules SFP équipés de lasers de classe 1.

Modules SFP Blackmagic Design recommandés:

- **3G-SDI:** PL-4F20-311C
- **6G-SDI:** PL-8F10-311C
- **12G-SDI:** PL-TG10-311C



Cet appareil ne peut être utilisé qu'à une altitude inférieure à 2000 mètres.

Déclaration de l'État de Californie

Ce produit est susceptible de vous exposer à des produits chimiques, dont le chrome hexavalent, reconnu par l'État de Californie comme étant responsable de cancers, d'anomalies congénitales ou d'autres effets nocifs sur la reproduction.

Pour de plus amples informations, veuillez vous rendre sur www.P65Warnings.ca.gov.

Avertissement destiné aux techniciens agréés



Attention — Système de fusibles bipolaire/neutre

La source d'alimentation de cet appareil contient un fusible dans les conducteurs de ligne et neutre. Elle est compatible avec le système de distribution électrique/réseau de distribution d'électricité en Norvège.

Garantie

Garantie limitée à 12 mois

Par la présente, Blackmagic Design garantit que le Blackmagic Duplicator 4K est exempt de défauts matériels et de fabrication pendant une durée de deux mois à compter de la date d'achat. Si un produit s'avère défectueux pendant la période de garantie, Blackmagic Design peut, à sa seule discrétion, réparer le produit défectueux sans frais pour les pièces et la main-d'œuvre, ou le remplacer.

Pour se prévaloir du service offert en vertu de la présente garantie, il vous incombe d'informer Blackmagic Design de l'existence du défaut avant expiration de la période de garantie, et de prendre les mesures nécessaires pour l'exécution des dispositions de ce service. Le consommateur a la responsabilité de s'occuper de l'emballage et de l'expédition du produit défectueux au centre de service nommé désigné par Blackmagic Design, en frais de port prépayé. Il incombe au consommateur de payer l'intégralité des frais de transport, d'assurance, des droits de douane et taxes et toutes autres charges relatives aux produits qui nous auront été retournés, et ce quelle que soit la raison.

La présente garantie ne saurait en aucun cas s'appliquer à des défauts, pannes ou dommages causés par une utilisation inappropriée ou un entretien inadéquat ou incorrect. Blackmagic Design n'a en aucun cas l'obligation de fournir un service en vertu de la présente garantie : a) pour réparer les dommages résultant de tentatives de réparations, d'installations ou tous services effectués par du personnel non qualifié par Blackmagic Design, b) pour réparer tout dommage résultant d'une utilisation inadéquate ou d'une connexion à du matériel incompatible, c) pour réparer tout dommage ou dysfonctionnement causés par l'utilisation de pièces ou de fournitures n'appartenant pas à la marque de Blackmagic Design, d) pour examiner un produit qui a été modifié ou intégré à d'autres produits quand l'impact d'une telle modification ou intégration augmente les délais ou la difficulté d'examiner ce produit. CETTE GARANTIE REMPLACE TOUTE GARANTIE EXPLICITE OU IMPLICITE. BLACKMAGIC DESIGN ET SES REVENDEURS DÉCLINENT EXPRESSÉMENT TOUTE GARANTIE IMPLICITE DE COMMERCIALISATION OU D'ADAPTATION DANS QUELQUE BUT QUE CE SOIT. LA RESPONSABILITÉ DE BLACKMAGIC DESIGN POUR RÉPARER OU REMPLACER UN PRODUIT S'AVÉRANT DÉFECTUEUX CONSTITUE LA TOTALITÉ ET LE SEUL RECOURS EXCLUSIF PRÉVU ET FOURNI AU CONSOMMATEUR POUR TOUT DOMMAGE INDIRECT, SPÉCIFIQUE, ACCIDENTEL OU CONSÉCUTIF, PEU IMPORTE QUE BLACKMAGIC DESIGN OU SES REVENDEURS AIENT ÉTÉ INFORMÉS OU SE SOIENT RENDU COMPTE AU PRÉALABLE DE L'ÉVENTUALITÉ DE CES DOMMAGES. BLACKMAGIC DESIGN NE PEUT ÊTRE TENU POUR RESPONSABLE DE TOUTE UTILISATION ILLICITE OU ABUSIVE DU MATÉRIEL PAR LE CONSOMMATEUR. BLACKMAGIC DESIGN N'EST PAS RESPONSABLE DES DOMMAGES RÉSULTANT DE L'UTILISATION DE CE PRODUIT. LE CONSOMMATEUR MANIPULE CE PRODUIT À SES SEULS RISQUES.

© Copyright 2019 Blackmagic Design. Tous droits réservés. 'Blackmagic Design', 'DeckLink', 'HDLink', 'Workgroup Videohub', 'Videohub', 'DeckLink', 'Intensity' et 'Leading the creative video revolution' sont des marques déposées aux États-Unis et dans d'autres pays. Tous les autres noms de société et de produits peuvent être des marques déposées des sociétés respectives auxquelles ils sont associés. Thunderbolt et le logo Thunderbolt sont des marques déposées d'Intel Corporation aux États-Unis et/ou dans d'autres pays.

Blackmagicdesign



Installations- und Bedienungsanleitung

Blackmagic Duplicator 4K

Februar 2019

Deutsch



Willkommen

Vielen Dank, dass Sie sich für den Kauf eines Blackmagic Duplicator 4K entschieden haben.

Wir sind überaus begeistert von unserem neuen Blackmagic Duplicator 4K. Er ist die Lösung schlechthin, wenn Sie Ihre Kunden ohne Verzug mit hochwertigen Ultra-HD-Inhalten versorgen möchten. Der Duplikator zeichnet auf 25 separate SD-Karten in SD-, HD- und Ultra-HD-Formaten bis zu 2160p/60 auf und verwendet die gängige H.264- oder die neueste H.265-Komprimierung. Dies bietet Ihnen beeindruckende Videoqualität und hohe Frameraten bei hinreichend niedrigen Datenraten, um preisgünstige Speicherkarten für lange Aufnahmedauern verwenden zu können.

Der Blackmagic Duplicator 4K lässt sich leicht einrichten und bedienen. Auf dem Frontpanel sind ein LCD und Bedienelemente eingelassen, über die Sie Einstellungen ändern und das Gerät mittels Tasten steuern können. Via Ethernet oder per Anschluss an eine RS-422-Steuereinheit lässt sich Ihr Duplikator auch aus der Ferne bedienen. Sie können sich sogar Ihre eigene Steuerung nach Maß anfertigen, um Ihr Gerät unter Einsatz des HyperDeck Ethernet Protocol zu verwenden.

Der integrierte H.265-Echtzeit-Encoder zeichnet hochwertiges Video auf preiswerte SD-Karten in Videoformaten bis zu Ultra HD 2160p/60 auf, d. h. Sie müssen nicht die derzeit schnellsten Speicherkarten verwenden, um Video in grandioser Ultra-HD-Qualität aufzuzeichnen. Wir haben die aktuellste Blackmagic Duplicator 4K Software in der Version 1.2 um H.264-Komprimierung erweitert. Das bringt mehr Kompatibilität und Sie können nun auch H.264-Dateien aufzeichnen.

Der Blackmagic Duplicator 4K ist nur eine Rackeinheit hoch. Auf diese Weise können Sie mehrere Geräte in Reihe schalten und zusammen in einem tragbaren Rack unterbringen, das sich bequem mit zum Drehort transportieren lässt. So sind Sie stets gewappnet, simultan auf Hunderten von SD-Karten aufzuzeichnen.

Diese Bedienungsanleitung enthält alle Informationen, die Sie zur Inbetriebnahme Ihres Blackmagic Duplicator 4K benötigen.

Bitte schauen Sie auf unserer Website unter der Rubrik Support unter www.blackmagicdesign.com/de nach der neuesten Ausgabe dieses Handbuchs. Dort finden Sie zudem aktuelle Software-Updates für Ihren Blackmagic Duplicator 4K. Indem Sie Ihre Software auf dem neuesten Stand halten, haben Sie stets Zugriff auf neue aktuelle Features! Wenn Sie Software herunterladen, empfehlen wir Ihnen, sich zu registrieren, sodass wir Sie über neue Updates informieren können, sobald diese zur Verfügung stehen. Da wir ständig an neuen Features und Verbesserungen arbeiten, freuen wir uns jederzeit über Ihre Beiträge.

A stylized, handwritten signature of Grant Petty in black ink.

Grant Petty

CEO, Blackmagic Design

Inhaltsverzeichnis

Blackmagic Duplicator 4K

Erste Schritte	116
Anschließen an das Stromnetz	116
Der Homescreen	116
Anschließen von Video- und Audioquellen	116
Einschieben und Formatieren von SD-Karten	118
Aufzeichnen	119
Einstellen des Aufzeichnungsmodus	119
Einstellen des Codecs	120
Einstellen der Bitrate	121
Aufzeichnen von Clips	122
LED-Statusanzeigen	122
Aufnahme anfügen	123
Sperrfunktion Ihres Blackmagic Duplicator 4K	124
Reihenschaltung mehrerer Dupliziergeräte	124
LCD-Menüeinstellungen	126
„Record“ (Aufzeichnen)	126
Einstellungen	131
„About“	132
Blackmagic Duplicator Utility	132
Aktualisierung Ihres Blackmagic Duplicator 4K	132
Dateinamenpräfix	132
Installation eines optionalen Optical Fiber SDI Module	133
RS-422-Steuerung	134
Was ist die RS-422-Steuerung?	134
Die Verwendung einer externen RS-422-Steuerung	134
RS-422 Developer Information	136
Fernsteuerung via Ethernet	136
Steuerung am Beispiel eines Arduino-Microcontrollers	137
Blackmagic HyperDeck Ethernet Protocol	139
Protocol Commands	139
Protocol Details	140
Configuring the watchdog	145
Configuring the record mode	145
Configuring the file format	145
Hilfe	146
Gesetzliche Vorschriften und Sicherheitshinweise	147
Sicherheitshinweise	148
Garantie	149

Erste Schritte

Der Start mit Ihrem Blackmagic Duplicator 4K ist ganz einfach!

Sie brauchen bloß ein Stromkabel einstecken, Ihre SDI-Videoquelle anschließen und bis zu 25 SD-Karten einschieben. Falls Sie noch mehr SD-Karten bespielen möchten, lassen sich mehrere Blackmagic Duplicator 4Ks in Reihe schalten. Dank der eingebauten Video- und Steuerungsanschlüsse, an die das jeweils nächste Gerät gekoppelt wird, ist das völlig unkompliziert. Dieser Abschnitt der Bedienungsanleitung zeigt Ihnen im Einzelnen, wie Sie Ihren Blackmagic Duplicator 4K einrichten. Dann können Sie sofort beginnen, auf mehreren SD-Karten simultan aufzuzeichnen.

Anschließen an das Stromnetz

Stecken Sie einfach ein IEC-Norm-konformes Stromkabel in die 110–240V-Wechselstrombuchse am Geräterücken.

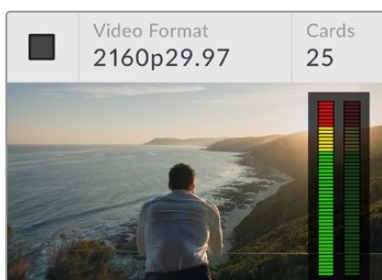

Sobald der Blackmagic Duplicator 4K mit Strom versorgt wird, öffnet sich der Homescreen auf dem eingebauten LCD

Der Homescreen

Der Homescreen zeigt Folgendes an: ein Bild des Quellvideos, Angaben wie das Quellvideoformat sowie die Anzahl der eingeschobenen SD-Karten. Des Weiteren gibt die Statusanzeige Aufschluss über den Aufzeichnungsstart und -stopp und über die Audiopegel-Meter lässt sich die Tonaussteuerung Ihres Quellvideos kontrollieren.

Anschließen von Video- und Audioquellen

Schließen Sie Ihre Videoquelle an den 12G-SDI-Eingang auf der Geräterückseite an. Ihr Blackmagic Duplicator 4K erkennt das Eingabeformat automatisch und zeigt es auf dem Homescreen des LCDs an.

Die BNC-Anschlüsse für ein- und ausgehendes SDI unterstützen Videosignale bis zu 12G-SDI, sodass Sie SD-, HD- oder Ultra-HD-Videoquellen bis 2160p/60 über ein einziges BNC-Kabel verbinden können. So stimmt die durchgeschleifte Ausgabe immer mit Ihrem Quellvideoformat überein und Sie können das gleiche Signal an weiteres SDI-Videoequipment weiterleiten, bspw. wenn mehrere Blackmagic Duplicator 4Ks in Reihe geschaltet sind. Überdies unterstützt das Gerät progressive segmentierte Frame-Modi und erkennt Level-A- und Level-B-3G-SDI-Formate für 1080p/50, 1080p/59,94 und 1080p/60.

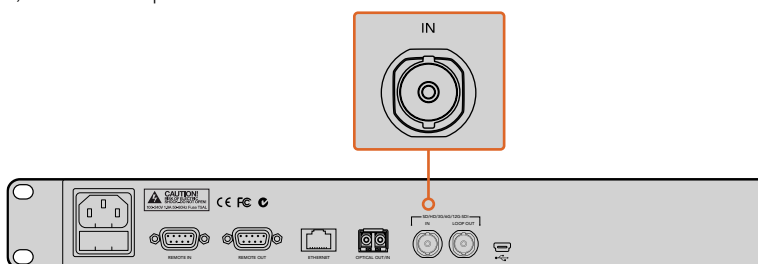

Schließen Sie Ihre Videoquelle an den SDI-Anschluss an. Der Ton ist in das SDI-Signal eingebettet

Ihr Blackmagic Duplicator 4K unterstützt zwei Kanäle mit eingebettetem SDI-Audio. Sie müssen bereits über den SDI-Videoeingang gekoppelte Tonquellen also nicht separat verbinden.

TIPP Sie können die Audiopegel Ihres Videos auf dem LCD-Homescreen kontrollieren.
Reihenschaltung

Es lassen sich auch mehrere Blackmagic Duplicator 4Ks in Reihe schalten, damit Sie auf noch mehr SD-Karten aufzeichnen können. Beispiel: Wenn Sie 100 Karten duplizieren möchten, müssen Sie lediglich vier Duplizierer in Reihe schalten.

- 1 Schließen Sie den RS-422-Ausgang („REMOTE OUT“) des ersten Blackmagic Duplicator 4K an den Eingang des zweiten Geräts an. Wiederholen Sie diesen Vorgang für jedes Gerät in der Reihe.
- 2 Koppeln Sie nach diesem Schema den durchgeschleiften SDI-Ausgang („LOOP OUT“) des ersten Geräts an den SDI-Eingang (LOOP IN) des zweiten. Wiederholen Sie dies für alle übrigen Geräte in der Reihe.
- 3 Auf dem Bedienfeld jedes Duplizierers befindet sich eine mit REM markierte Taste. Es handelt sich hierbei um die Remote-Taste (Fernbedienung), die für diesen Betriebsmodus auf allen Geräten aktiviert sein muss. Drücken Sie die REM-Tasten auf allen in Reihe geschalteten Geräten, angefangen vom zweiten.

HINWEIS Achten Sie darauf, dass die REM-Taste am ersten Gerät ausgeschaltet ist, da dieser Blackmagic Duplicator 4K alle weiteren Geräte in der Reihe steuert. Das erste Gerät, dessen REM-Taste ausgeschaltet ist, fungiert als Mastereinheit. Jede an seiner Frontblende gedrückte Taste wirkt sich über den REMOTE-Ausgang auf die nachfolgenden Geräte aus, deren REM-Tasten aktiviert sind, und steuert sie auf diese Weise. Jedes mit RS-422-MAZ-Steuerung ausgerüstete TV-Produkt kann als Mastereinheit fungieren, da dieses Fernbedienungsprotokoll das branchenübliche MAZ-Steuerformat ist.

Jetzt sind alle in Reihe geschalteten Blackmagic Duplicator 4Ks bereit, den Befehlen des ersten Dupliziergerätes zu folgen.

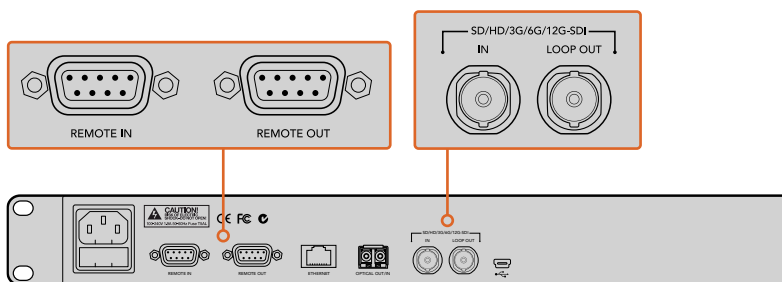

Die REMOTE- und LOOP-Anschlüsse dienen zur Reihenschaltung mehrerer Blackmagic Duplicator 4Ks. Über den LOOP-Anschluss des letzten Geräts in der Reihe kann überdies Quellvideo zu anderem SDI-Equipment wie bspw. einem Blackmagic SmartView Monitor oder einem HyperDeck Diskrekorder durchgeschleift werden.

Einzelheiten über die Reihenschaltung mehrerer Geräte finden Sie im Abschnitt „Reihenschaltung mehrerer Dupliziergeräte“.

Einschieben und Formatieren von SD-Karten

Der Blackmagic Duplicator 4K arbeitet mit gängigen SD-Karten der Klasse 10. Sie brauchen also nicht in die schnellsten Karten auf dem Markt zu investieren. SD-Karten sind in jedem Kamerageschäft erhältlich. SD-Karten der Klasse 10 gibt es sogar in manchen Supermärkten.

TIPP Auf den Labels von SD-Karten wird Ihnen eine aufgedruckte Zahl von 1–10 in einem Kreis auffallen. Diese Zahlen deuten die Geschwindigkeitskategorie der Karte an, wobei 10 die schnellste ist. Karten mit einer umkreisten 10 sind SD-Karten der Klasse 10. Das ist der Kartentyp, den Sie für Aufzeichnungen von Video bis zu Ultra HD bei der höchsten Bitrateneinstellung benötigen.

So schieben Sie eine SD-Karte ein:

- 1 Halten die Karte mit den goldenen Kontakten in Richtung LCD und richten Sie sie an einem der SD-Kartenschächte des Blackmagic Duplicator 4K aus.
- 2 Drücken Sie die Karte sanft in den Schacht, bis sie eingerastet ist. Sobald die Karte aufnahmebereit ist, leuchtet die LED-Anzeige über dem Kartenschacht nach rascher Überprüfung der Karte grün.

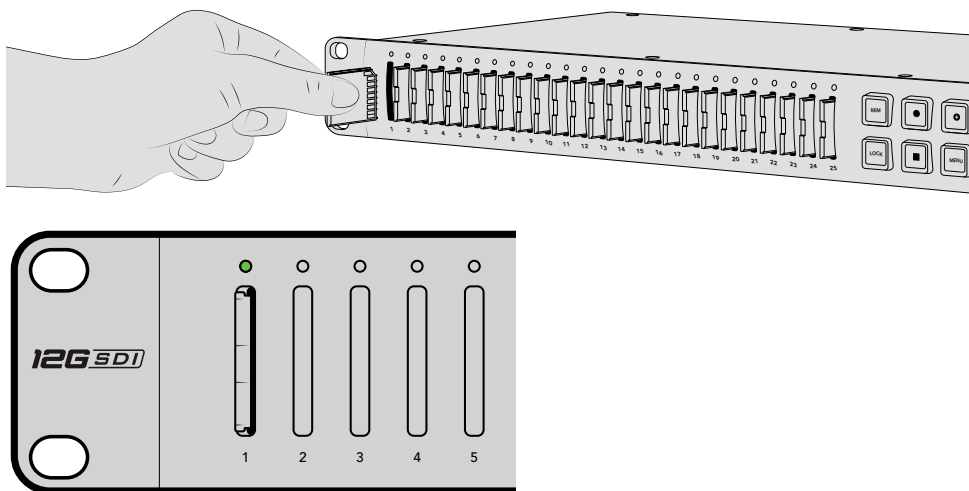

Halten Sie die Karte mit den goldenen Kontakten in Richtung LCD und schieben Sie sie sanft in einen der SD-Kartenschächte, bis sie eingerastet ist. Sobald Ihre Karte aufnahmebereit ist, leuchtet die LED-Statusanzeige grün.

Um eine Karte zu entnehmen, ergreifen Sie sie an den Rändern und ziehen Sie sie aus dem Schacht.

TIPP Vergewissern Sie sich beim Einführen einer Karte, dass sie nicht schreibgeschützt ist. Durch Umlagen des kleinen Plastischalters an der linken Kartenseite zu den Anschlüssen hin, lässt sich der Schreibschutz aufheben. Nach erfolgter Aufzeichnung können Sie den Schreibschutz der Karte wiederherstellen, indem Sie den Schalter in seine Abwärtsposition zurücklegen.

Formatieren von SD-Karten

Ehe die Aufzeichnung losgehen kann, müssen Sie Ihre SD-Karten zunächst in exFAT formatieren. Das ist ein mit macOS- und Windows-Computern kompatibles Format. Ihre Datenträger lassen sich anhand der „Format“-Funktion Ihres Blackmagic Duplicator 4K bequem formatieren. So können auf einem Gerät bis zu 25 SD-Karten gleichzeitig formatiert werden.

So formatieren Sie Ihre SD-Karten mit dem Blackmagic Duplicator 4K:

- 1 Drücken Sie die MENU-Taste (Menü) auf dem Bedienfeld.
- 2 Drücken Sie unter den erleuchteten Menü-Multifunktionstasten auf beiden Seiten des LCDs auf „Record“ (Aufzeichnen).
- 3 Drücken Sie die linke Pfeiltaste, um die Einstellung „Format Cards“ (Karten formatieren) auszuwählen. Drücken Sie dann unten rechts im LCD-Menü auf „Format“ (Formatieren).
- 4 Nun erscheint ein Warnfenster und fordert Sie auf, das Format zu bestätigen. Drücken Sie die Menü-Multifunktionstaste neben „Format“ oder auf „Cancel“, um den Vorgang abzubrechen.
- 5 Über einen Fortschrittsbalken können Sie die Formatierung verfolgen. Drücken Sie nach abgeschlossener Formatierung auf „OK“.
- 6 Drücken Sie die MENU-Taste im Bedienfeld, um zum Homescreen zurückzukehren.

Für den Einstieg war das schon alles. Nun sind Ihre Video- und Audioquellen angeschlossen und Ihre SD-Karten formatiert – damit sind Sie startklar fürs Aufzeichnen!

TIPP Die Formatierung von SD-Karten verschiedener Machart und Größe vollzieht sich ggf. in unterschiedlichem Tempo. Manche Karten sind also schneller fertig formatiert als andere.

Aufzeichnen

Durch Drücken der Aufnahmetaste im Bedienfeld können Sie sofort aufzeichnen. Wir raten Ihnen jedoch, vorher den Aufzeichnungsmodus, den Codec und die Bitrate vorzugeben, denn diese Werte bestimmen die zu verwendende Art sowie die Dauer und Qualität Ihrer Aufzeichnung.

Einstellen des Aufzeichnungsmodus

Der Blackmagic Duplicator 4K verfügt über folgende Aufzeichnungsmodi:

- **Duplicate:** auf alle SD-Karten gleichzeitig aufzeichnen
- **Single Disk:** auf eine SD-Karte nach der anderen aufzeichnen und die Aufnahme stoppen, wenn die letzte Karte voll ist
- **Single Disk Overwrite:** auf eine SD-Karte nach der anderen aufzeichnen und in einer Endlosschleife überschreiben

Duplicate Mode

Im „Duplicate“-Modus zeichnet der Blackmagic Duplicator 4K dieselben Videoinhalte auf alle SD-Karten gleichzeitig auf.

Single Disk Mode

Der Blackmagic Duplicator 4K eignet sich ideal als Logging-Rekorder für eine Vielzahl von Anwendungen von TV-Broadcasts bis hin zu Überwachungskameras. Er zeichnet jeweils auf einen SD-Schacht auf. Ist die darin befindliche SD-Karte voll, wird die Aufzeichnung im nächsten verfügbaren Schacht fortgesetzt. Im „Single Disk“-Modus stoppt der Blackmagic Duplicator 4K die Aufnahme, sobald alle SD-Karten voll sind. Mit SD-Karten in allen 25 Kartenschächten können Sie ohne Weiteres eine Woche lang aufnehmen. Für eine fortlaufende ununterbrochene Aufzeichnung können Sie volle Karten jederzeit durch leere ersetzen.

Bei Reihenschaltung mehrerer Dupliziergeräte können Sie sogar noch länger aufnehmen. Sobald alle Karten im Master-Gerät voll sind, wird die Aufnahme auf allen angeschlossenen Slave-Geräten fortgesetzt, bis auch diese voll sind. Die Aufnahme stoppt, wenn die letzte Karte im letzten Gerät voll ist.

Single Disk Overwrite Mode

Im „Single Disk Overwrite“-Modus kann der Blackmagic Duplicator 4K mit zwei oder mehr SD-Karten in Endlosschleife aufzeichnen und immer wieder zur ersten Karte zurückspringen, wenn die letzte voll ist. Es wird jeweils in einem SD-Schacht nach dem anderen aufgezeichnet. Sobald eine SD-Karte voll ist, formatiert das Gerät die Karte im nächsten verfügbaren Schacht und zeichnet weiter auf diese auf.

Dieser Modus ähnelt dem „Single Disk“-Modus, jedoch formatiert und zeichnet das Gerät in Dauerschleife auf anstatt nach der letzten vollen Karte zu stoppen. Im „Single Disk Overwrite“-Modus zeichnet Ihr Blackmagic Duplicator 4K unbegrenzt lange auf, bis sie „Stop“ drücken.

TIPP Bei der Aufzeichnung im „Single Disk“- oder „Single Disk Overwrite“-Modus können Sie jederzeit neue SD-Karten mit freiem Speicherplatz einschieben. Der Blackmagic Duplicator 4K setzt die Aufnahme so lange fort, wie es freien Speicherplatz auf einer Karte in einem der 25 Schächte gibt.

So geben Sie einen Aufzeichnungsmodus vor:

- 1 Versorgen Sie den Blackmagic Duplicator 4K mit Strom.
- 2 Drücken Sie die „Menu“-Taste am vorderen Bedienfeld, um das LCD-Menü zu öffnen. Über die beleuchteten Multifunktionstasten neben dem LCD gelangen Sie zu verschiedenen Menüoptionen. Drücken Sie die Multifunktionstaste „Record“ (Aufzeichnen).

Die Punkte am unteren Rand des LCD-Einstellungsmenüs „Record“ zeigen an, wie viele Optionen verfügbar sind. Um zu einem beliebigen Zeitpunkt zur vorherigen Menüebene zurückzukehren, drücken Sie die Taste „Back“ (Zurück). Verwenden Sie die Pfeiltasten, um durch die Optionen zu scrollen.
- 3 Navigieren Sie zur Option „Mode“ (Modus) und drücken Sie „Change“ (Ändern).
- 4 Drücken Sie „Select“ (Auswählen), um den derzeit angezeigten Modus zu verwenden. Das LCD-Menü zeigt Ihnen die ausgewählte Option an.
- 5 Drücken Sie die „Back“-Taste, um zum Einstellungsmenü „Record“ zurückzukehren. Die ausgewählte Option wird nun angezeigt.

Weitere Informationen zur Reihenschaltung mehrerer Dupliziergeräte finden Sie in den Abschnitten „Reihenschaltung“ und „Reihenschaltung mehrerer Dupliziergeräte“.

TIPP Sollten Sie bei der Aufzeichnung einer wichtigen Veranstaltung im „Single Disk“- oder „Single Disk Overwrite“-Modus eine SD-Karte entfernen wollen, bevor diese voll ist, drücken Sie einfach die Aufnahmetaste und halten Sie diese drei Sekunden lang gedrückt, um die Aufnahme auf der nächsten SD-Karte fortzusetzen. Bei der Aufzeichnung im „Duplicate“-Modus können Sie die Taste „Append Record“ drücken. Weitere Informationen finden Sie unter „Aufnahme anfügen“.

Einstellen des Codecs

Ihr Blackmagic Duplicator 4K kann Dateien unter Verwendung der Komprimierungscodecs H.264 oder H.265 aufzeichnen. Standardmäßig komprimiert der Duplicator 4K mit H.264.

So ändern Sie den eingestellten Codec:

- 1 Drücken Sie die MENU-Taste (Menü).
- 2 Drücken Sie die Multi-Funktionstaste neben „Record“, um die Aufnahmeeinstellungen zu öffnen.

- 3 Benutzen Sie die Pfeiltasten, um in die Einstellung „Codec“ zu gelangen und drücken Sie auf „Change“ (Ändern).
- 4 Wählen Sie ebenfalls mithilfe der Pfeiltasten den gewünschten Codec aus. Drücken Sie dann auf „Set“, um die Änderungen zu bestätigen. Alternativ können Sie die Einstellungen auch mit der MENU-Taste bestätigen. Diese führt Sie anschließend zurück zum Homescreen.

HINWEIS Um Codecs wechseln zu können, muss Ihr Blackmagic Duplicator 4K mit Software in der Version 1.1 oder höher betrieben werden. Weitere Informationen zum Aktualisieren der Software finden Sie im Abschnitt „Blackmagic Duplicator Utility“ in dieser Bedienungsanleitung.

Den richtigen Codec auswählen

Für optimale Kompatibilität empfehlen wir den H.264-Codec. Darum haben wir dem Blackmagic Duplicator 4K standardmäßig den H.264-Codec vorgegeben.

Für hochwertiges Ultra-HD-Video und kleinere Dateigrößen bietet sich der H.265-Codec an. Weil er noch sehr neu ist, ist er jedoch ggf. mit weniger Computern und Wiedergabegeräten kompatibel.

Beide Codecs haben ihre Vorteile. Wenn Sie mit H.265 arbeiten, wird die Speicherung auf SD-Karten günstiger, da geringere Bitraten und Dateigrößen für die jeweilige Bildqualität anfallen. Wo es bei einem Projekt auf Kompatibilität ankommt, ist H.264 hingegen eine großartige Auswahl.

Einstellen der Bitrate

Ihr Blackmagic Duplicator 4K bietet Ihnen drei Bitraten-Einstellungen an: „Low“, „Medium“ und „High“ (niedrig, mittel und hoch). Anhand dieser Einstellungen geben Sie den Datenstrom in Bits vor, den der eingebaute H.265-Kodierer pro Videosekunde schreibt. Für hochwertige Aufzeichnungen mit überschaubaren Dateigrößen ist die Bitrate auf den Mittelwert „Medium“ eingestellt. Über das LCD-Menü können Sie diese Einstellung jedoch bequem ändern.

So ändern Sie die eingestellte Bitrate:

- 1 Drücken Sie die MENU-Taste (Menü).
- 2 Drücken Sie die Multi-Funktionstaste neben „Record“, um die Aufnahmeeinstellungen zu öffnen.
- 3 Benutzen Sie die Pfeiltasten, um in die Einstellung „Bit Rate“ zu gelangen und drücken Sie dann auf „Change“ (Ändern).
- 4 Wählen Sie ebenfalls mithilfe der Pfeiltasten die gewünschte Bitrate aus und drücken auf „Set“, um die Änderungen zu bestätigen. Alternativ können Sie die Einstellungen auch mit der MENU-Taste bestätigen. Diese führt Sie anschließend zurück zum Homescreen.

HINWEIS Höhere Bitraten ergeben hochwertigere Aufzeichnungen, füllen aber die Karte schneller bzw. erfordern eine teurere Karte mit mehr Speicherkapazität. Eine geringere Datendurchsatzrate verlängert die Aufnahmedauer einer Karte, allerdings reduziert dies die Bildqualität ggf. auf ein geringeres Niveau als gewünscht.

Deshalb zahlt sich etwas Experimentieren mit verschiedenen Bitraten aus, damit Sie genau die gewünschte Bildqualität bei möglichst kleinen Dateigrößen erzielen.

Aufzeichnen von Clips

Um mit der Aufzeichnung zu beginnen, drücken Sie die Aufnahmetaste im Bedienfeld. Während der Aufzeichnung leuchten die LED-Statusanzeigen für den jeweiligen Steckplatz rot auf. Wird die Aufzeichnung angehalten, leuchtet die LED-Statusanzeige grün. Dies zeigt an, dass die Aufzeichnung erfolgreich war und die Karte für die Aufzeichnung eines weiteren Clips bereit ist. Ihre Aufzeichnungen können Sie mühelos über den SD-Kartensteckplatz oder -Leser eines Computers oder auf einem HDMI-Fernseher überprüfen, vorausgesetzt dieser unterstützt SD-Karten und das exFAT-Dateisystem.

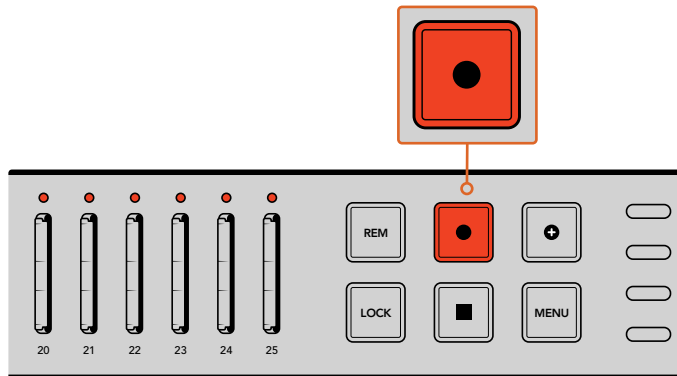





Drücken Sie die Aufnahmetaste, um mit der Aufzeichnung zu beginnen. Die Status-LEDs über jedem Steckplatz leuchten nun rot. So wissen Sie, dass die SD-Karten aufzeichnen

LED-Statusanzeigen

Die Status-LEDs über jedem Steckplatz leuchten in unterschiedlichen Farben, um Ihnen den jeweiligen Status des Steckplatzes anzuzeigen. Wenn Sie bspw. eine SD-Karte einführen, leuchtet die LED des Steckplatzes grün, sobald die Karte erkannt wurde und aufnahmebereit ist.

Unten finden Sie eine Beschreibung zu den LED-Farben, dem LED-Verhalten und dem Status, den sie anzeigen:

-  **Konstantes Grün**
Bereit zur Aufzeichnung. Die LED leuchtet grün und zeigt damit an, dass die SD-Karte aufnahmebereit ist.
-  **Konstantes Rot**
Zeichnet auf. Die LED leuchtet durchgehend rot, solange ein Clip aufgezeichnet wird.
-  **Rot blinkend**
Zeichnet auf und die Karte ist fast voll. Die LED blinkt, wenn auf der Karte weniger als 3 Minuten Speicherplatz verfügbar sind.
-  **Schnell Rot blinkend**
Einzelbilder werden ausgelassen. Die Schreibgeschwindigkeit der SD-Karte ist zu langsam und entspricht nicht der Aufnahmegeschwindigkeit.
-  **Konstantes Gelb**
Karte voll, schreibgeschützt oder Schreibfehler aufgetreten. Wenn die LED während der Aufzeichnung durchgehend gelb leuchtet, kann es sein, dass Ihre SD-Karte fehlerhaft, schreibgeschützt, noch nicht formatiert ist oder weniger als 10 Sekunden Speicherplatz verbleiben. Versuchen Sie, die Karte zu entsperren, die Datenrate zu verringern, sie zu formatieren oder sie gegen eine schnellere SD-Karte auszutauschen.

Auch wenn der Duplizierer versuchen wird, das Dateisystem auf jeder Karte in Ordnung und bereitzuhalten, falls eine Karte während des Aufzeichnungsvorgangs entfernt wird, ist es wichtig, dass Sie keine Karte entfernen, während Ihr Blackmagic Duplicator 4K aufzeichnet. Das liegt daran, dass

einige Betriebssysteme, die zum Anzeigen der Karte benutzt werden, nicht so zuverlässig sind wie andere und die Aufzeichnung dadurch für beschädigt halten. Demnach ist es immer sicherer, die Aufzeichnung zu stoppen, bevor die Karte entfernt wird. Wenn Sie dennoch die Möglichkeit haben möchten, Karten bereits an Menschen verteilen zu können, bevor eine Veranstaltung abgeschlossen ist, ist es ratsam, mehrere Duplizierer einzusetzen. Auf diese Weise können Sie die Aufzeichnung mit einem Gerät beenden und die Karten von diesem Gerät verteilen. Die übrigen Geräte können so weiterhin aufzeichnen.

TIPP SD-Karten der Geschwindigkeitsklasse 10 eignen sich zur Aufzeichnung aller von Ihrem Blackmagic Duplicator 4K unterstützten Bitraten. Wenn nötig können Sie jedoch auch bei geringeren Datendurchsatzraten mit weniger schnellen Karten aufnehmen. Beispiel: Es soll über einen längeren Zeitraum hinweg Footage von Sicherheitskameras aufgenommen werden, es wird aber keine Videohöchstqualität benötigt. Wir empfehlen immer, eine Testaufnahme vorzunehmen, damit Sie sichergehen können, dass Ihre SD-Karte die Videoaufzeichnung in Ihrer vorgegebenen Bitrate meistert. Weitere Informationen zu den Geschwindigkeitsklassen von SD-Karten finden Sie unter „Einschieben und Formatieren von SD-Karten“ im Abschnitt „Erste Schritte“.

Aufnahme anfügen

Bei der Aufzeichnung im „Duplicate“-Modus wollen Sie möglicherweise einen neuen Clip aufzeichnen und diesen an einen vorherigen Clip anfügen, um beide zusammen als einzelnen Clip anzuzeigen. Vielleicht möchten Sie ja eine Veranstaltung mit mehreren separaten Auftritten aufzeichnen. Wenn Sie jeden Auftritt einzeln aufzeichnen, jedoch alle zu einem einzigen Clip zusammenfügen wollen, kann Ihnen die Funktion „Append Record“ (Aufnahme anfügen) dabei behilflich sein.

- 1 Zeichnen Sie den ersten Clip wie gehabt mithilfe der Aufnahmetaste auf. Drücken Sie die Stoptaste.
- 2 Wenn der nächste Auftritt beginnt, drücken Sie die Taste „Append Record“. Die Taste leuchtet daraufhin zusammen mit der Aufnahmetaste auf und zeigt Ihnen somit an, dass der derzeit aufgezeichnete Clip an den vorherigen Clip angefügt wird.
- 3 Drücken Sie die Stoptaste. Der neue Clip wird dann an den vorherigen Clip angefügt. Beide Clips werden somit in einer Datei abgespeichert.

TIPP Bei Verwendung der Funktion „Append Record“ können Sie eine unbegrenzte Zahl an Clips an den ersten Clip anfügen. Dabei sollten Sie nur die Speicherkapazität der Karte und Aufzeichnungsspannen bedenken.

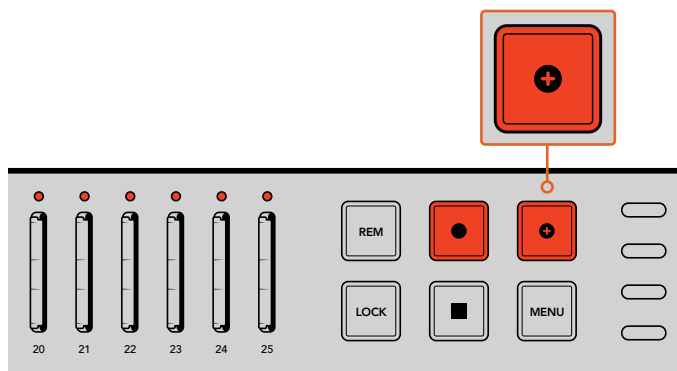

Drücken Sie die Taste „Append Record“ erneut, um dem soeben aufgezeichneten Clip einen weiteren hinzuzufügen.

TIPP Bei der Aufzeichnung im „Single Disk“- oder „Single Disk Overwrite“-Modus können Sie die Aufnahmetaste drücken und drei Sekunden gedrückt halten, um die Aufzeichnung auf der nächsten Karte fortzusetzen. Damit geben Sie die aktuelle Karte frei. Das ist praktisch, wenn Sie unmittelbar nach einer wichtigen Veranstaltung auf die Aufnahme zugreifen wollen, ohne die Aufzeichnung zu stoppen. Weitere Informationen zu den „Single Disk“- und „Single Disk Overwrite“-Modi finden Sie im Abschnitt „Einstellen des Aufzeichnungsmodus“. Bei der Aufzeichnung im „Duplicate“-Modus können Sie die Taste „Append Record“ drücken. Weitere Informationen finden Sie unter „Aufnahme anfügen“.

Sperrfunktion Ihres Blackmagic Duplicator 4K

Wenn Sie ein wichtiges Ereignis filmen, ist es ratsam, das Bedienfeld zu sperren, um zu verhindern, dass die Aufzeichnung aus Versehen gestoppt wird. Es ist auch hilfreich, jegliche in Reihe geschalteten Slave-Geräte zu sperren, damit die Aufzeichnung auch von deren Bedienelementen nicht versehentlich unterbrochen werden kann.

Die Sperrung wird für jedes Gerät einzeln mit der jeweiligen LOCK-Taste aktiviert bzw. deaktiviert. Es ist sehr unwahrscheinlich, dass die Sperrung versehentlich aufgehoben wird, da die LOCK-Taste für die Freigabe der Bedienelemente zwei Sekunden lang gedrückt gehalten werden muss.

So sperren Sie einen Blackmagic Duplicator 4K:

- 1 Drücken Sie die LOCK-Taste im Bedienfeld Ihres Blackmagic Duplicator 4K.
- 2 Um das Gerät zu entsperren, halten Sie die LOCK-Taste gedrückt. Nach zwei Sekunden wird das Gerät entsperrt.

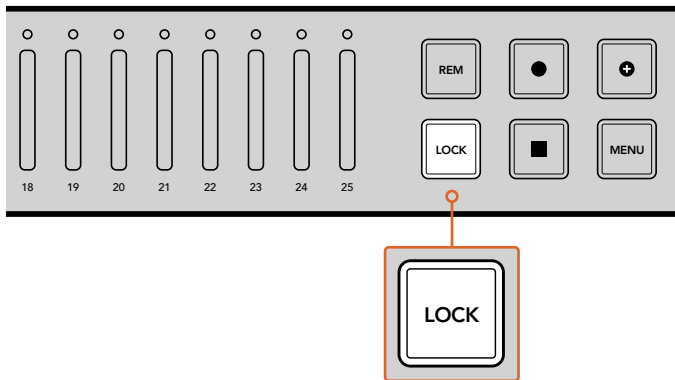

Mit der Sperrung Ihres Blackmagic Duplicator 4K stellen Sie sicher, dass eine Aufzeichnung nicht versehentlich gestoppt wird

Reihenschaltung mehrerer Dupliziergeräte

Wenn Sie mehr als 25 SD-Karten bespielen möchten, können Sie mehrere Blackmagic Duplicator 4Ks hintereinander schalten. Bei dieser Reihenschaltung werden alle Geräte über ihren jeweiligen SDI-Durchschleifverbinder mit ein und demselben Videosignal gespeist. Gleichzeitig kommunizieren sie über ihre Fernsteuerungsanschlüsse und das RS-422-Protokoll.

So schalten Sie mehrere Blackmagic Duplicator 4K hintereinander:

- 1 Verbinden Sie den RS-422-Ausgang („REMOTE OUT“) des ersten Geräts mit dem Eingang („REMOTE IN“) des zweiten Geräts. Benutzen Sie hierfür ein gängiges serielles Kabel mit DB9-Verbindern. Serielle Kabel mit DB9-Verbindern sind bei einem Fachhändler für Computer oder Videoausrüstung in Ihrer Nähe erhältlich.
- 2 Verbinden Sie nun den SDI-Durchschleifausgang („LOOP“) des ersten Geräts mit dem SDI-Eingang des zweiten Geräts.

Einfacher geht's kaum! Um noch weitere Blackmagic Duplicator 4Ks in Reihe zu schalten, koppeln Sie einfach weiterhin jeden REMOTE- und LOOP-Ausgang des vorherigen Geräts an den REMOTE- und SDI-Eingang des Folgegeräts.

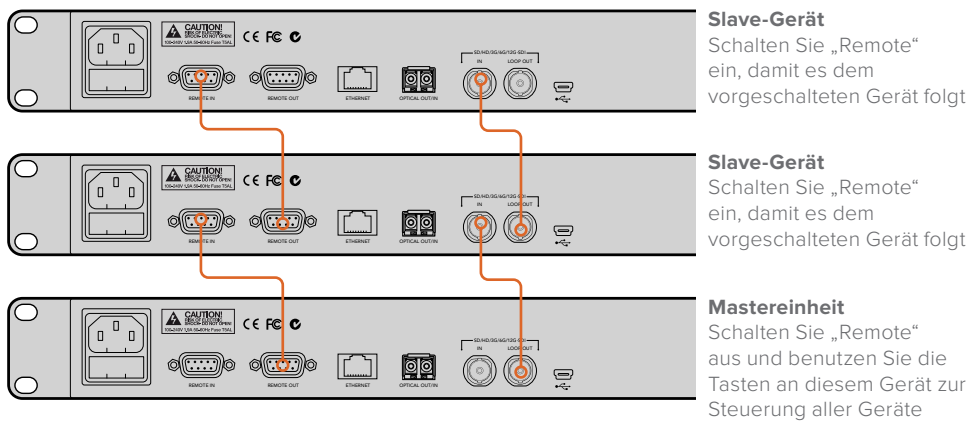

Um mehrere Blackmagic Duplicator 4Ks in Reihe zu schalten, verbinden Sie einfach den LOOP-Ausgang eines Geräts mit dem SDI-Eingang eines weiteren Geräts. Koppeln Sie nach dem gleichen Schema den REMOTE-Ausgang eines Geräts an den REMOTE-Eingang eines zweiten Geräts

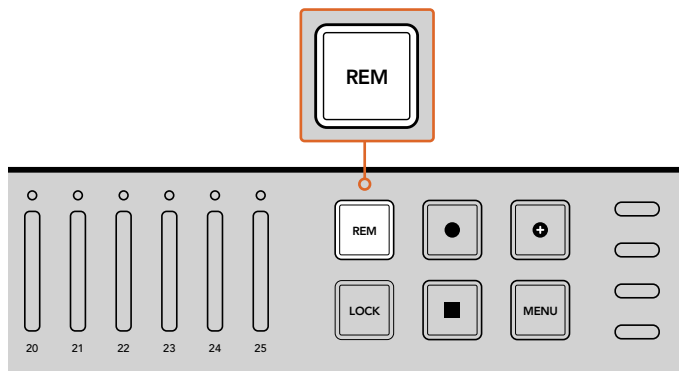

Drücken Sie bei jedem Slave-Gerät dieser Reihenschaltung auf die jeweilige REM-Taste (Remote), damit alle über das Ausgangsgerät gesteuert werden können

HINWEIS Vergewissern Sie sich, dass Sie die REM-Taste im Bedienfeld jedes einzelnen Slave-Geräts drücken, um die Fernsteuerung zu aktivieren. Ist die REM-Taste aktiviert, leuchtet sie auf. Zum Deaktivieren erneut drücken.

Es empfiehlt sich, vor der eigentlichen Aufzeichnung eine Testaufzeichnung durchzuführen, um sicherzustellen, dass alle Geräte auch tatsächlich von der Mastereinheit gesteuert werden. Sollten nicht alle Geräte auf die Mastereinheit reagieren, vergewissern Sie sich, dass die REM-Taste der Mastereinheit deaktiviert ist. Die REM-Tasten der Slave-Geräte müssen jedoch aktiviert sein.

LCD-Menüeinstellungen

Die Einstellungen Ihres Blackmagic Duplicator 4K können allesamt über das Bedienfeld und das LCD-Menü sowie die Menü-Multifunktionstasten verändert werden. Die Menü-Multifunktionstasten befinden sich auf beiden Seiten neben dem LCD und leuchten entsprechend der auf dem LCD angezeigten Einstellungen auf.

So ändern Sie Einstellungen:

- 1 Drücken Sie die MENU-Taste im Bedienfeld, um die LCD-Menüeinstellungen aufzurufen.
- 2 Benutzen Sie die Menü-Multifunktionstasten für die Menünavigation.
- 3 Wenn Sie eine Einstellung ausgewählt haben, drücken Sie Menü-Multifunktionstaste neben „Change“ (Ändern).
- 4 Passen Sie die Einstellung an und drücken Sie dann „Set“, um die Änderungen zu bestätigen.

Sie können eine Änderung jederzeit durch Drücken der Menü-Multifunktionstaste „Back“ (Zurück) verwerfen. Dies führt Sie zum vorherigen Schritt des Menüpfads zurück. Alternativ können Sie durch Drücken der MENU-Taste direkt zum Homescreen zurückkehren.

„Record“ (Aufzeichnen)

Im Einstellungsmenü „Record“ (Aufzeichnen) können Sie die Videoquelle ändern, die Bitrate vorgeben, Trigger-Aufzeichnung aktivieren oder deaktivieren und Ihre SD-Karten formatieren.

Videoquelle

Sofern ein Glasfaser-SDI-Modul installiert ist, können Sie im Einstellungsmenü „Video Source“ zwischen dem SDI-Eingang und dem Glasfasereingang wählen.

Modus

Mit dieser Einstellung wählen Sie den Aufzeichnungsmodus aus:

Duplicate

Dieselben Videoinhalte auf alle SD-Karten gleichzeitig aufzeichnen.

Single Disk

Auf eine SD-Karte nach der anderen aufzeichnen und zur nächsten verfügbaren SD-Karte wechseln, sobald die SD-Karte voll ist. Wenn alle SD-Karten voll sind, stoppt der Blackmagic Duplicator 4K die Aufzeichnung. Sind mehrere Geräte in Reihe geschaltet, wird die Aufnahme so lange auf dem nächsten Blackmagic Duplicator 4K fortgesetzt, bis alle SD-Karten voll sind.

Single Disk Overwrite

In einer Endlosschleife aufzeichnen. Auf eine SD-Karte nach der anderen aufzeichnen und zur nächsten verfügbaren SD-Karte wechseln, sobald die SD-Karte voll ist. Wenn alle Karten voll sind, springt der Blackmagic Duplicator 4K wieder zur ersten SD-Karte zurück und setzt die Aufnahme fort.

Codec

Über diese Einstellung geben Sie vor, ob Ihr Blackmagic Duplicator 4K mit dem Kompressionscodec H.264 oder H.265 aufzeichnet.

Nachstehend werden die beiden unterschiedlichen Codecs beschrieben.

H.264

Ein sehr gebräuchlicher Kompressionsstandard, der einen guten Kompromiss zwischen Bildqualität und Dateigröße erzielt. Das Gros der in den letzten 10 Jahren hergestellten Playbackgeräte kann in diesem Codec aufgezeichnete Dateien mit mindestens bis HD aufgelöstem Video anzeigen.

H.265

Dieser hocheffiziente Kompressionsstandard reduziert die Größe von Videodateien für die jeweilige Bildqualität im Vergleich zu H.264 um die Hälfte. Ein exzellenter Codec zum Speichern von hochqualitativem Video oder Ultra-HD-Video, dessen Wiedergabe jedoch ggf. Playbacksoftware und -hardware jüngerer Datums erfordert.

HINWEIS Weitere Einzelheiten über die Unterschiede zwischen H.264 und H.265 finden Sie im Abschnitt „Aufzeichnen“ in dieser Bedienungsanleitung.

Bitrate

Anhand der Bitrate wird festgelegt, wie viel und in welcher Qualität Video auf Ihre SD-Karten geschrieben werden kann. Sie können zwischen drei Optionen wählen.

High

Wählen Sie „High“ (Hoch), wenn Sie sich für Video von höchster Qualität und geringster Kompression entschieden haben.

Medium

Wählen Sie „Medium“ (Mittel), wenn Sie Video von längerer Dauer aber dennoch sehr guter Qualität auf Ihre SD-Karten aufzeichnen wollen.

Low

Wählen Sie „Low“, (Niedrig) wenn Sie Video von langer Dauer aufzeichnen wollen und nicht die höchste Qualität benötigen. Bei dieser Einstellung wird Video am stärksten komprimiert und es kann in Ihrer Aufzeichnung zu wahrnehmbaren Komprimierungsartefakten kommen.

HINWEIS Der integrierte H.265-Kodierer bedient sich der modernsten Komprimierungstechnik, d. h. Sie bekommen qualitativ hochwertiges Video mit der kleinstmöglichen Datengröße. Die Qualität Ihrer Aufzeichnung wird sogar dann noch sehr gut sein, wenn Sie die niedrigste Qualitätseinstellung mit der höchsten Komprimierung wählen.

Bitraten für Videoformate

Ultra HD			
Videoformat	Bitraten-Einstellung	Bitrate (Mbit/s) H.264	Bitrate (Mbit/s) H.265
2160p60	Hoc	75	50
	Mittel	66	38
	Niedrig	50	20
2160p59.94	Hoc	75	50
	Mittel	66	38
	Niedrig	50	20

Ultra HD			
Videoformat	Bitraten-Einstellung	Bitrate (Mbit/s) H.264	Bitrate (Mbit/s) H.265
2160p50	Hoc	72	48
	Mittel	61	32
	Niedrig	42	16
2160p30	Hoc	50	30
	Mittel	37	20
	Niedrig	24	10
2160p29.97	Hoc	50	30
	Mittel	37	20
	Niedrig	24	10
2160p25	Hoc	40	25
	Mittel	32	18
	Niedrig	20	10
2160p24	Hoc	40	25
	Mittel	32	18
	Niedrig	20	10
2160p23.98	Hoc	40	25
	Mittel	32	18
	Niedrig	20	10

HD			
Videoformat	Bitraten-Einstellung	Bitrate (Mbit/s) H.264	Bitrate (Mbit/s) H.265
1080p60	Hoc	40	20
	Mittel	32	15
	Niedrig	20	10
1080i60	Hoc	40	20
	Mittel	32	15
	Niedrig	20	10
1080p59.94	Hoc	40	20
	Mittel	32	15
	Niedrig	20	10
1080i59.94	Hoc	40	20
	Mittel	32	15
	Niedrig	20	10
1080p50	Hoc	36	20
	Mittel	28	15
	Niedrig	18	10

HD			
Videoformat	Bitraten-Einstellung	Bitrate (Mbit/s) H.264	Bitrate (Mbit/s) H.265
1080i50	Hoc	36	20
	Mittel	28	15
	Niedrig	18	10
1080p30	Hoc	28	15
	Mittel	20	11
	Niedrig	11	7
1080p29.97	Hoc	28	15
	Mittel	20	11
	Niedrig	11	7
1080p25	Hoc	24	15
	Mittel	16	10
	Niedrig	9	6
1080p24	Hoc	24	15
	Mittel	15	10
	Niedrig	8	6
1080p23.98	Hoc	24	15
	Mittel	15	10
	Niedrig	8	6
720p60	Hoc	25	12
	Mittel	17	10
	Niedrig	9	8
720p59.94	Hoc	25	12
	Mittel	17	10
	Niedrig	9	8
720p50	Hoc	20	12
	Mittel	14	9
	Niedrig	7	6

SD			
Videoformat	Bitraten-Einstellung	Bitrate (Mbit/s) H.264	Bitrate (Mbit/s) H.265
625i50 PAL	Hoc	18	11
	Mittel	12	8
	Niedrig	6	6
525i59.94 NTSC	Hoc	20	12
	Mittel	14	9
	Niedrig	7	6

„Trigger“ (Auslöser)

Die „Trigger“-Einstellung aktiviert die Aufnahmeauslösung. Mit dieser Funktion können Sie die Aufzeichnung Ihres Blackmagic Duplicator 4K über die Aufnahmetaste von anderen SDI-Geräten – wie bspw. der Blackmagic URSA Mini – auslösen.

None

Wählen Sie „None“ (Keine), um die Aufnahmeauslösung zu deaktivieren.

SDI Start/Stop

Wenn „SDI Start/Stop“ ausgewählt ist, beginnt Ihr Blackmagic Duplicator 4K mit der Aufzeichnung, sobald die Aufnahmetaste an einem anderen Gerät gedrückt wird.

Die Blackmagic URSA Mini sendet bspw. über ihre SDI-Ausgänge immer ein Trigger-Signal. Wenn Sie also die Aufnahmetaste an Ihrer Kamera betätigen, beginnt Ihr Blackmagic Duplicator 4K mit der Aufzeichnung. Drücken Sie die Aufnahmetaste erneut, wird die Aufzeichnung unterbrochen. Um die Aufnahmeauslösung der URSA Mini zu aktivieren, brauchen Sie keine Einstellungen vornehmen. Sollten Sie jedoch andere SDI-Geräte verwenden wollen, die die Aufnahmeauslöserfunktion unterstützen, müssen Sie „SDI Start/Stop“ im Einstellungsmenü Ihres jeweiligen Geräts aktivieren.

Timecode Run

Sollte Ihr SDI-Equipment die Aufnahmeauslösung „SDI Start/Stop“ nicht unterstützen, können Sie Ihren Blackmagic Duplicator 4K so einstellen, dass er mit der Aufzeichnung beginnt, sobald er laufenden Timecode erkennt. Hier ein Beispiel: Sie haben eine SDI-Kamera an Ihren Blackmagic Duplicator 4K angeschlossen, bei der die Timecode-Funktion „Record Run“ aktiviert ist. Sobald diese Kamera beginnt aufzuzeichnen, löst sie gleichzeitig die Aufzeichnungsfunktion des Blackmagic Duplicator 4K aus. Wenn Sie die Aufzeichnung an Ihrer Kamera beenden, wird auch der Timecode angehalten und somit der Aufzeichnungsvorgang Ihres Blackmagic Duplicator 4K ebenfalls gestoppt.

Diese Funktion ist toll! Vergewissern Sie sich jedoch, dass die Funktion „Record Run“ in den Timecode-Einstellungen Ihres Geräts aktiviert ist. Wenn in den Timecode-Einstellungen nämlich „Time of Day“ vorgegeben ist, gibt Ihr Gerät kontinuierlich Timecode aus und würde so die Aufzeichnung Ihres Blackmagic Duplicator 4K permanent auslösen. Und das möchten Sie ja sicherlich nicht.

Formatierung von Karten

Mit der Formatierungsfunktion Ihres Blackmagic Duplicator 4K können Sie bis zu 25 Karten gleichzeitig formatieren.

So formatieren Sie Ihre Karten:

- 1** Drücken Sie die MENU-Taste im Bedienfeld, um das LCD-Menü zu öffnen.
- 2** Über die Menü-Multifunktionstaste neben „Record“ gelangen Sie in die Aufzeichnungseinstellungen „Record“.
- 3** Navigieren Sie mit der linken und rechten Pfeiltaste zur Einstellung „Format Cards“ (Karten formatieren) und drücken Sie die Taste für „Format“ (Formatieren).
- 4** Nun wird eine Meldung angezeigt, die Sie auffordert, das Format zu bestätigen. Es erscheint zudem ein Warnhinweis, dass dieser Vorgang nicht rückgängig gemacht werden kann. Sollten sich demnach Daten auf Ihrer SD-Karte befinden, die Sie erhalten möchten, erstellen Sie zunächst ein Backup, bevor Sie mit der Formatierung fortfahren.
- 5** Bestätigen Sie den Vorgang mit „Format“ (Formatieren). Alternativ können Sie den Vorgang mit der Taste „Cancel“ abbrechen und zum Einstellungsmenü „Record“ zurückkehren.
- 6** Während des Formatierungsprozesses blinken die Status-LEDs gelb und auf dem LCD erscheint ein Fortschrittsbalken. Sobald die Karten formatiert sind, leuchten die Statusanzeigen konstant grün. Zusätzlich wird Ihnen auf dem LCD angezeigt, dass die Formatierung abgeschlossen ist und Ihre Karten nun aufzeichnungsbereit sind.
- 7** Drücken Sie „OK“. Drücken Sie dann die MENU-Taste im Bedienfeld, um zum Homescreen zurückzukehren.

Einstellungen

Über den Menüpunkt „Settings“ (Einstellungen) können Sie Netzwerkeinstellungen für DHCP, IP-Adresse, Subnetzmaske und Gateway vorgeben. Wenn Sie Ihren Blackmagic Duplicator 4K in ein Netzwerk einbinden, können Sie das Gerät mithilfe einer Verwaltungssoftware von Fremdherstellern wie Telnet fernsteuern.

„DHCP ,ON“

Wenn Sie möchten, dass Ihr Blackmagic Duplicator 4K automatisch die passendsten Einstellungen konfiguriert, sobald er in ein Netzwerk eingebunden wird, wählen Sie „On“ (Eingeschaltet). Das bedeutet, dass Ihr Blackmagic Duplicator 4K alle verbundenen Geräte im Netzwerk überprüft und seine IP-Adresse und anderen Netzwerkeinstellungen so wählt, dass sie nicht mit denen der übrigen Geräte in Konflikt geraten. Dies ist eine zuverlässige und einfache Methode, die passenden Netzwerkeinstellungen zu erhalten.

„DHCP ,OFF“

Wenn Sie Ihre Netzwerkeinstellungen komplett selbst vorgeben möchten, können Sie diese auch manuell eintragen, indem Sie die Einstellung „DHCP“ auf „Off“ (Aus) setzen. Geben Sie daraufhin die IP-Adresse, Subnetzmaske und Gateway-Einstellungen ein.

IP-Adresse, Subnetzmaske und Gateway

Ist „DHCP“ mit „Off“ ausgeschaltet, können Sie diese Einstellungen manuell ändern.

So bearbeiten Sie die Zahlenfelder:

- 1 Wählen Sie das zu ändernde Zahlenfeld mithilfe der linken und rechten Menü-Multifunktionsstasten aus und drücken Sie auf „Change“ (Ändern).
- 2 Mit der linken und rechten Menü-Multifunktionsstaste können Sie nun die Zahlenwerte verändern. Wenn Sie eine der Tasten gedrückt halten, verändert sich der Wert schneller.
- 3 Drücken Sie auf „SET“, um die Änderung zu bestätigen.

Mit den Menü-Multifunktionsstasten können Sie sich so durch die Sequenz arbeiten und die gewünschten Änderungen vornehmen.



Über das LCD-Menü Settings können Sie Ihre Netzwerkeinstellungen ändern, damit Sie Ihren Blackmagic Duplicator 4K mit Verwaltungssoftware von Fremdherstellern wie Telnet steuern können.

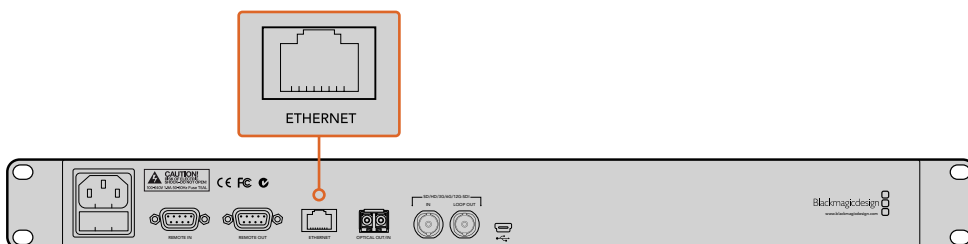

Verbinden Sie Ihren Blackmagic Duplicator 4K über den Ethernet-Eingang am Geräterücken mit Ihrem Netzwerk

„About“

Diese Menüeinstellung gibt einen sofortigen Überblick über die aktuell vorgegebene Bitrate, den Dateinamen Ihrer jüngsten Aufzeichnung, den Netzwerkstatus und die Versionsnummer der auf Ihrem Blackmagic Duplicator 4K installierten Produktsoftware.

Blackmagic Duplicator Utility

Aktualisierung Ihres Blackmagic Duplicator 4K

Die Blackmagic Duplicator Utility Software dient der Aktualisierung von Produktsoftware für Ihren Blackmagic Duplicator 4K. Man kann damit auch die Einstellung „File Name Prefix“ (Dateinamenpräfix) ändern, um Aufzeichnungen mit Kennungen zu versehen. Laden Sie sich diese Software unbedingt herunter und aktualisieren Sie Ihren Blackmagic Duplicator 4K, um von neuen Features und Verbesserungen zu profitieren.

Die aktuellste Version steht zum Download im Blackmagic Design Support Center unter www.blackmagicdesign.com/de/support bereit.

So aktualisieren Sie die Produktsoftware unter macOS:

- 1 Downloaden und entpacken Sie Blackmagic Duplicator Utility.
- 2 Öffnen Sie das angezeigte Disk-Symbol und starten Sie das Blackmagic Duplicator Utility Installationsprogramm. Folgen Sie den Anweisungen auf Ihrem Bildschirm.
- 3 Koppeln Sie Ihren Blackmagic Duplicator 4K nach erfolgter Installation der aktuellsten Blackmagic Duplicator Utility Software mit einem USB-Kabel an Ihren Computer.
- 4 Starten Sie die Duplicator Utility Software und öffnen Sie die Einstellungen, indem Sie auf das kreisförmige Einstellungssymbol klicken. Wenn die Software eine bereits installierte, frühere Version auf Ihrem Blackmagic Duplicator 4K erkennt, wird ein „Update now“-Symbol angezeigt. Klicken Sie das Symbol einfach an, um die Produktsoftware zu aktualisieren. Wenn die aktuellste Version der Produktsoftware bereits auf Ihrem Blackmagic Duplicator 4K installiert ist, brauchen Sie nichts weiter zu tun.

So aktualisieren Sie die Produktsoftware unter Windows:

- 1 Downloaden und entpacken Sie Blackmagic Duplicator Utility.
- 2 Jetzt sollte ein Ordner namens „Blackmagic Duplicator Utility“ zu sehen sein, der diese Bedienungsanleitung und das Installationsprogramm für Blackmagic Duplicator Utility enthält. Doppelklicken Sie auf das Installationsprogramm und folgen Sie den Bildschirmmanweisungen zur Fertigstellung der Installation.
- 3 Verbinden Sie Ihren Blackmagic Duplicator 4K nach erfolgter Installation der aktuellsten Blackmagic Duplicator Utility Software über ein USB-Kabel mit Ihrem Computer.
- 4 Starten Sie die Duplicator Utility Software und öffnen Sie die Einstellungen, indem Sie auf das kreisförmige Einstellungssymbol klicken. Wenn die Software eine bereits installierte, frühere Version auf Ihrem Blackmagic Duplicator 4K erkennt, wird ein „Update now“-Symbol angezeigt. Klicken Sie das Symbol einfach an, um die Produktsoftware zu aktualisieren. Wenn die aktuellste Version der Produktsoftware bereits auf Ihrem Blackmagic Duplicator 4K installiert ist, brauchen Sie nichts weiter zu tun.

Dateinamenpräfix

Sie können den Dateinamenpräfix ändern, damit sich Ihre Aufzeichnungen kennzeichnen und leichter identifizieren lassen. Klicken Sie einfach auf die Dialogbox „File Name Prefix“ und tippen Sie einen neuen Namen ein. Wenn Ihr Blackmagic Duplicator 4K nun den nächsten Clip aufnimmt, wird er mit einem benutzerdefinierten Namen gefolgt von vier Ziffern zur Identifikation der Clipnummer versehen. Diese Ziffern erhöhen sich mit jedem aufgezeichneten Clip.

Überdies können Sie sicherstellen, dass die Aufzeichnungen auf allen in Reihe geschalteten Geräten den gleichen Dateinamen verwenden. Aktivieren Sie hierfür die REM-Tasten (= Remote) aller Slave-Geräte und ändern Sie dann die Dateinamenpräfix-Einstellung auf dem Master-Gerät. Dies ermöglicht Ihnen, auf den Karten aller Geräte Clips mit dem gleichen Dateinamen aufzunehmen.

Installation eines optionalen Optical Fiber SDI Module

Wenn Sie SDI-Video per Lichtwellenleiter anschließen möchten, erfordert dies die Installation eines optionalen Glasfaser-SDI-Moduls. Für die Installation eignet sich jedes beliebige SMPTE-kompatible Glasfaser-SDI-Modul. Solche Module können Sie separat bei jedem Blackmagic Design Reseller kaufen. Das Modul wird einfach in den eingebauten Glasfaserkäfig am Geräterücken Ihres Blackmagic Duplicator 4K eingesteckt. Das installierte Glasfaser-SDI-Modul lässt Sie SDI-Video mit eingebettetem Ton über außerordentlich lange Kabelstrecken anschließen. Sie können auch den Glasfaserausgang als zusätzlichen durchgeschleiften Videoanschluss verwenden.

Wenn Sie mit Glasfasersystemen von geringerer Geschwindigkeit wie 3G-SDI oder 6G-SDI arbeiten, können Sie ein langsames Modul in diese Buchse stecken. So sparen Sie Geld, wenn keine höheren Geschwindigkeiten gebraucht werden.

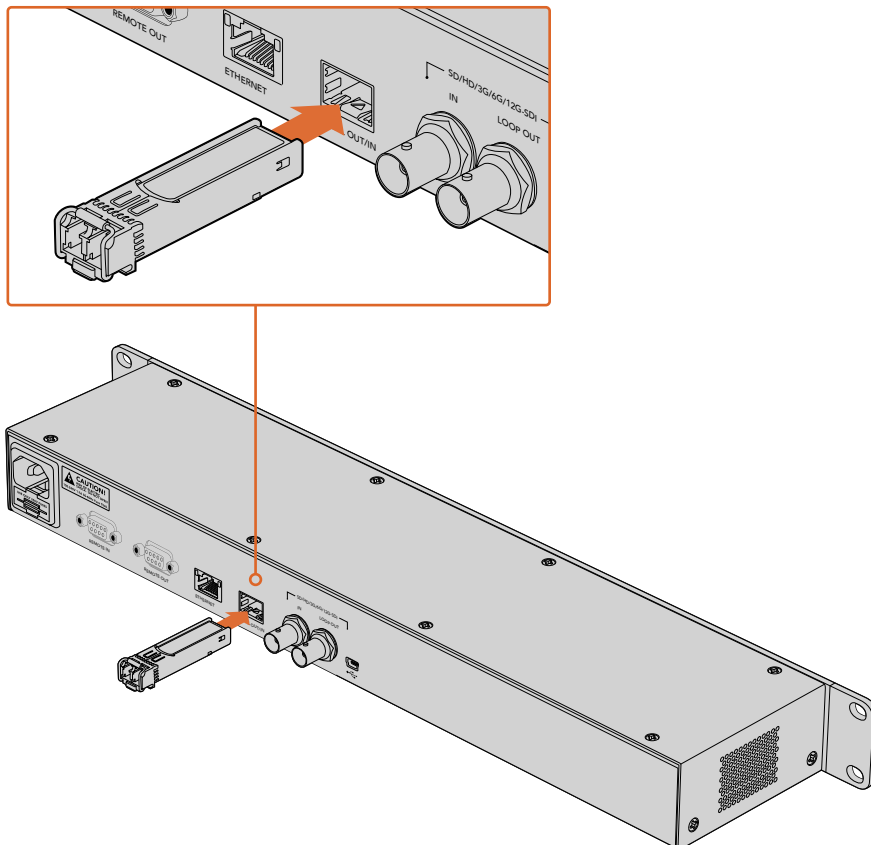

Installieren Sie ein optionales Glasfaser-SDI-Modul, damit Sie SDI-Video per Glasfaser koppeln können

Der Blackmagic Duplicator 4K verwendet das Video vom jeweils zuerst gekoppelten Anschluss. Sind allerdings SDI und Glasfaser belegt, können Sie über die „Video Source“-Einstellung auf dem LCD-Menü zwischen beiden auswählen. Näheres finden Sie im Abschnitt „Einstellungen“ in diesem Handbuch.

RS-422-Steuerung

Was ist die RS-422-Steuerung?

Der Broadcast-Standard RS-422 dient zur seriellen Decksteuerung und ist bei Broadcastern seit den frühen 1980er Jahren in Gebrauch. Er wird mit vielen MAZen sowie linearen Schnittsystemen und nichtlinearen automatisierten Schnitt- und Broadcast-Systemen verwendet. Ihr Blackmagic Duplicator 4K unterstützt diesen Standard, d. h. er lässt sich in automatisierte Broadcast-Anlagen, Fernsteuersysteme, zeitgesteuerte Aufnahmesysteme sowie in Steuerlösungen eigener Konzeption integrieren.

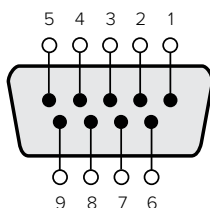

Senden (-)	Senden (+)	Empfangen (-)	Empfangen (+)	Erdungsstifte
2	7	8	3	1, 4, 6, 9

RS-422 Remote-Pin-Verbindungen am Remote-Ausgabeverbinder

Die Verwendung einer externen RS-422-Steuerung

Ihr Blackmagic Duplicator 4K ist mit einem branchenüblichen Sony™-kompatiblen RS-422-Port für die Deck-Fernsteuerung ausgestattet. Dieser verfügt über passende Stiftverbinder, die einen direkten Anschluss an beliebige Fernsteuerungsgeräte mit RS-422 ermöglichen.

Sie können vorgefertigte vorkonfektionierte 9-Stift-Kabel verwenden, sofern beide Kabelenden Stift für Stift verdrahtet sind und die Stiftnummern an beiden Enden einander entsprechen. Bei anders verdrahtetem Equipment oder wenn Sie sich Kabel eigener Spezifikation erstellen möchten, orientieren Sie sich bitte am beigefügten Anschlussschema für die Remote-Ausgänge. So gehen Sie sicher, dass die Tx-Stifte tatsächlich für die Übermittlung und die Rx-Stifte für den Empfang verdrahtet sind.

Über eine an Ihren Blackmagic Duplicator 4K angeschlossene RS-422-Steuerung können Sie das Gerät aus der Ferne bedienen, statt an einem Gerät vor Ort auf Tasten zu drücken.

- 1 Schließen Sie Ihre externe Steuerung über ein RS-422 Kabel an den „REMOTE IN“-Eingang Ihres Blackmagic Duplicator 4K an.
- 2 Drücken Sie die REM-Taste (= Remote) auf dem Bedienfeld Ihres Blackmagic Duplicator 4K, um die Decksteuerung aus der Ferne zu aktivieren.

Jetzt können Sie mit Ihrem Blackmagic Duplicator 4K aus der Ferne Aufnahmen starten und stoppen oder das Einfügen von Aufnahmen per „Append Record“ starten und stoppen. Eine vollständige Liste mit RS-422-Befehlen finden Sie im folgenden Abschnitt namens „Unterstützte RS-422-Befehle“.

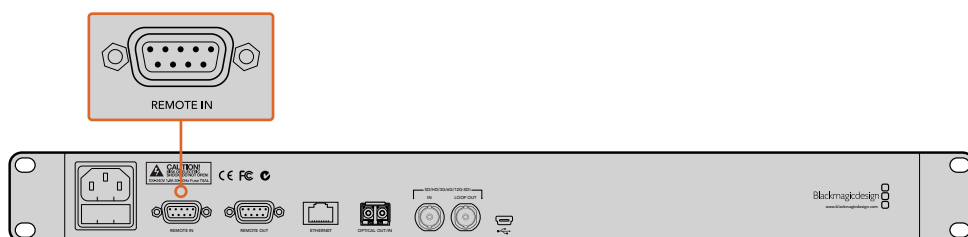

Koppeln Sie eine externe RS-422-Steuerung an den „REMOTE IN“-Eingang Ihres Blackmagic Duplicator 4K, um ihn fernzusteuern

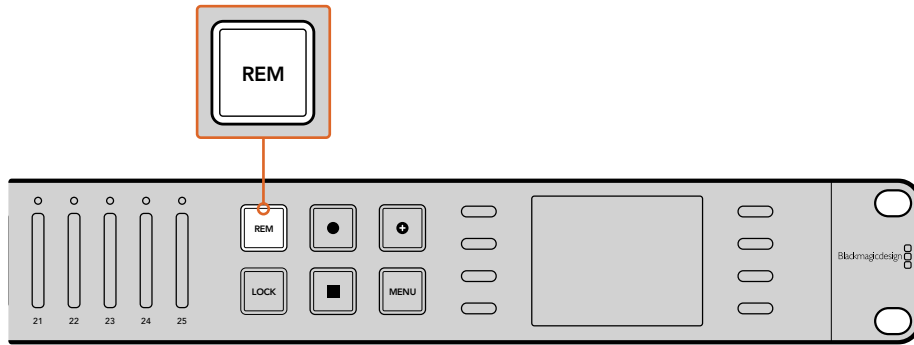

Drücken Sie die REM-Taste (= Remote) auf dem Bedienfeld Ihres Blackmagic Duplicator 4K, um die RS-422-Decksteuerung zu aktivieren

Supported RS-422 Commands

		Command	Reply	No Remote	Notes
0 - System Control					
0x00	0x11	DeviceTypeRequest	NTSC: 0xF0E0 PAL: 0xF1E0 24P: 0xF2E0	Enabled	–

1 - Slave Response					
0x20	0x00	Stop	Acknowledge	Disabled	–
0x20	0x02	Record	Acknowledge	Disabled	–
0x21	0x02	Append	Acknowledge	Disabled	Non-standard command - an extra payload of 0x00 indicates append

4 - Preset/Select Control					
0x40	0x40	AutoMode Off	Acknowledge	Disabled	ignored, Status bit remembered
0x40	0x41	AutoMode On	Acknowledge	Disabled	ignored, Status bit remembered
0x61	0x20	StatusSense	StatusData	Enabled	–

7 - Sense Reply					
0x70	0x20	StatusData	–	–	Please see “Status Bits” sheet: Limited to 9 bytes of status, silently truncated

RS-422 Developer Information

	Bit 7	Bit 6	Bit 5	Bit 4	Bit 3	Bit 2	Bit 1	Bit 0
Byte 0	0	0	Cassette out	0	0	0	0	Local
Byte 1	Standby	0	Stop	0	0	0	Record	0
Byte 2	0	0	0	0	0	0	0	0
Byte 3	Auto Mode	0	0	0	0	0	0	0
Byte 4	Select EE	Full EE	0	0	0	0	0	0
Byte 5	0	0	0	0	0	0	0	0
Byte 6	0	0	0	0	0	0	0	0
Byte 7	0	0	0	0	0	0	0	0
Byte 8	0	0	0	0	0	0	0	0
Byte 9	0	0	0	0	0	0	0	0

Variables	
Cassette Out	Set if no cards are ready to record
Local	Set if in local mode (no remote control)
Standby	Set if one or more cards are ready to record
Auto Mode	For compatibility only
Full EE	For compatibility only - always on
Select EE	For compatibility only - always on

Blackmagic Duplicator 4K RS-422 Settings	
Protocol	Based on Sony 9-pin protocol
Baud Rate	38.4 K
Start Bits	1
Data Bits	8
Stop Bits	1
Parity Bits	1
Parity Type	Odd

Fernsteuerung via Ethernet

Ihr Blackmagic Duplicator 4K lässt sich via Ethernet anhand von textbasierten Befehlen des Blackmagic HyperDeck Ethernet Protocol extern bedienen. Dies befähigt Sie, Ihren Blackmagic Duplicator 4K mittels einer Verwaltungssoftware wie Telnet über einen Computer fernzusteuern. Sie können sich auch eine Hardware-Systemsteuerung nach eigenen Spezifikationen bauen und diese mithilfe des HyperDeck Ethernet Protocol auf Integration mit dem Blackmagic Duplicator 4K programmieren.

Damit ist Ihnen die Möglichkeit gegeben, sich eigene Speziallösungen zur Steuerung Ihres Dupliziergerätes mit Computern, mit speziellen Hardware-Steuergeräten oder mit den in Broadcast-Studios oder Ü-Wagen eingesetzten Großanlagen zu entwickeln. So lassen sich beispielsweise kleine Leiterplatten wie Arduino-Microcontroller anhand von Erweiterungsplatten, sogenannten „Shields“ bzw. Schirmungen, individuell einrichten. Es gibt vielerlei Schirmungstypen passend für unterschiedliche Verbinder. Zur Steuerung Ihres Blackmagic Duplicator 4K ist eine Ethernet-Schirmung erforderlich. Es gibt sogar zusätzliche Schirmungen mit programmierbaren Tasten zu kaufen! Arduino-Microcontroller sind einfach einzurichten, sehr preiswert und im Sinne von Open Source quelloffen. Nach erfolgter Programmierung der Arduino-Software koppeln Sie den Arduino einfach an den Ethernet-Port Ihres Blackmagic Duplicator 4K. Sie können das Dupliziergerät dann sofort steuern.

Steuerung am Beispiel eines Arduino-Microcontrollers

Die Programmierung der Arduino-Microcontroller erfolgt in der gängigen C-Programmiersprache. Programmieren Sie Ihren Controller also einfach so, dass er Befehle an Ihren Blackmagic Duplicator 4K über das HyperDeck Ethernet Protocol auslöst. Alle unterstützten Befehle sind im nachstehenden Abschnitt „Blackmagic HyperDeck Ethernet Protocol“ aufgeführt.

Der Arduino kann mit zusätzlichen Erweiterungsschirmungen versehen werden, um damit diverse Aufnahmefunktionen auszuführen. Beispiel: Durch Hinzufügen einer internen Uhr können Sie Ihren Controller so programmieren, dass er dem Blackmagic Duplicator 4K befiehlt, zu bestimmten Tageszeiten aufzunehmen. Das mag bspw. bei Aufzeichnungen von Überwachungskameras praktisch sein.

Wir sind von dieser Technik vollends begeistert und würden gerne erfahren, was für externe Ethernet-Controller Sie sich gebaut haben.

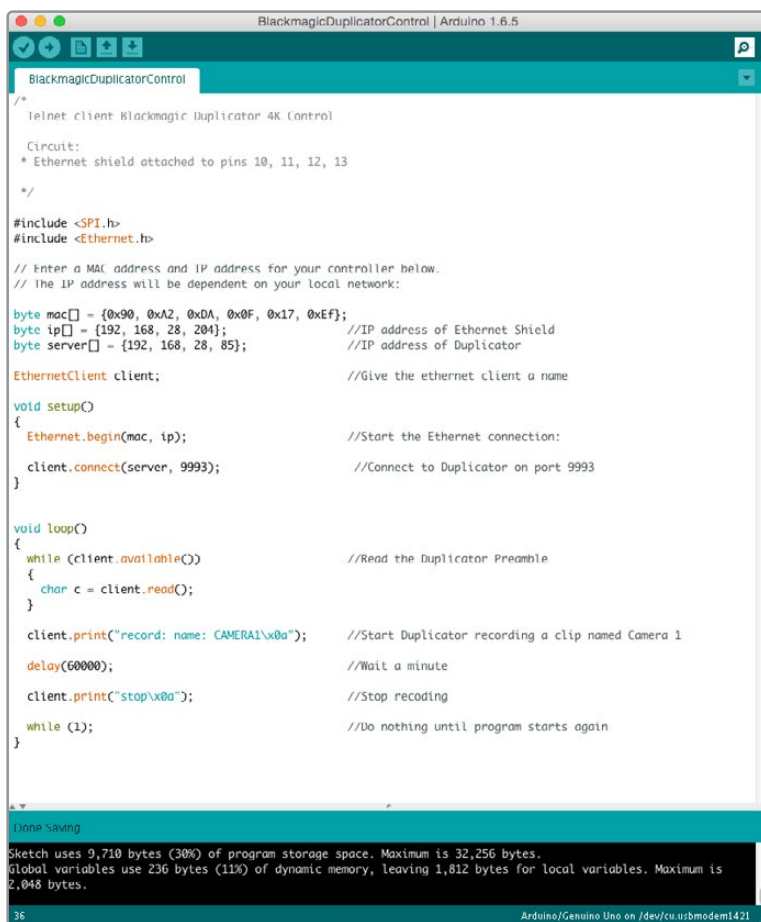

```
BlackmagicDuplicatorControl | Arduino 1.6.5

/*
 * Telnet client Blackmagic Duplicator 4K control
 *
 * Circuit:
 * Ethernet shield attached to pins 10, 11, 12, 13
 */

#include <SPI.h>
#include <Ethernet.h>

// Enter a MAC address and IP address for your controller below.
// The IP address will be dependent on your local network:

byte mac[] = {0x90, 0xA2, 0xDA, 0x0F, 0x17, 0xEF};
byte ip[] = {192, 168, 28, 204}; //IP address of Ethernet Shield
byte server[] = {192, 168, 28, 85}; //IP address of Duplicator

EthernetClient client; //Give the ethernet client a name

void setup()
{
  Ethernet.begin(mac, ip); //Start the Ethernet connection:
  client.connect(server, 9993); //Connect to Duplicator on port 9993
}

void loop()
{
  while (client.available()) //Read the Duplicator Preamble
  {
    char c = client.read();
  }

  client.print("record: name: CAMERA1\x0a"); //Start Duplicator recording a clip named Camera 1
  delay(60000); //Wait a minute
  client.print("stop\x0a"); //Stop recording
  while (1); //Do nothing until program starts again
}

Done Saving
Sketch uses 9,710 bytes (30%) of program storage space. Maximum is 32,256 bytes.
Global variables use 236 bytes (11%) of dynamic memory, leaving 1,812 bytes for local variables. Maximum is 2,048 bytes.
36 Arduino/Genuino Uno on /dev/cu.usbmodem1421
```

Orientieren Sie sich zum Programmieren eines externen Ethernet-Controllers – wie dem hier als Beispiel verwendeten Arduino mit Ethernet-Schirmung – an der hier dargestellten Ethernet-Protokoll-Referenz. Wählen Sie dort die von Ihnen benötigten Befehle für Ihre gewünschte Steuerung aus.

Sie finden den im obigen Fenster angezeigten Code überdies auf der nächsten Seite, wo sie ihn kopieren und in Ihre Arduino-IDE einfügen können. Der Code programmiert den Arduino, sodass dieser dem Blackmagic Duplicator 4K befiehlt, eine Minute lang aufzunehmen, dann die Aufnahme zu pausieren und erst wieder aufzunehmen, wenn das Programm weiterläuft.

```

/*
   Telnet client Blackmagic Duplicator 4K Control Circuit: *
Ethernet shield attached to pins 10, 11, 12, 13
*/
#include <SPI.h>
#include <Ethernet.h>

// Enter a MAC address and IP address for your controller below.
// The IP address will be dependent on your local network:
byte mac[] = {0x90, 0xA2, 0xDA, 0x0F, 0x17, 0xEF};
byte ip[] = {192, 168, 28, 204};          // IP address of
Ethernet Shield
byte server[] = {192, 168, 28, 141};     // IP address of Duplicator
EthernetClient client;                  // Give the ethernet
client a name

void setup()
{
  Ethernet.begin(mac, ip); //Start the Ethernet connection:

  client.connect(server, 9993);          //Connect to Duplicator
on port 9993
}
void loop()
{
  while (client.available())            //Read the Duplicator Preamble
  {
    char c = client.read();
  }
  client.print("record: name: Camera1\x0a");
//Start Duplicator recording a clip named Camera 1
  delay(60000);                          //Wait a minute
  client.print("stop\x0a");              //Stop recoding
  while (1);                              //Do nothing until program
starts again
}

```

Blackmagic HyperDeck Ethernet Protocol

Das textbasierte Blackmagic HyperDeck Ethernet Protocol wurde ursprünglich geschrieben, um Blackmagic HyperDeck Diskrekorder über den Ethernet-Port zu steuern. Mit dem gleichen Protokoll können Sie jedoch auch Ihren Blackmagic Duplicator 4K steuern.

Da das Dupliziergerät lediglich aufzeichnet, ist nur ein Teil der Befehle des HyperDeck Protokolls relevant. In diesem Abschnitt sind alle für den Blackmagic Duplicator 4K bei Einsatz mit dem HyperDeck Ethernet Protocol verfügbaren Befehle aufgeführt.

Protocol Commands

Command	Command Description
help or ?	Provides help text with all commands and parameters.
remote	Queries the state of HyperDeck's remote control mode.
remote: enable: true	Enables remote control.
remote: enable: false	Disables remote control.
remote: override: true	Turns remote override on.
remote: override: false	Turns remote override off.
quit	Disconnects HyperDeck server.
ping	Determines HyperDeck server is responding.
record	Starts recording.
record: append: true	Starts appended recording.
stop	Stops playback or recording.
commands	Lists all supported commands in an XML format.
notify	Queries the current state of all notifications.
notify: transport: true	Enables transport notifications.
notify: transport: false	Disables transport notifications.
notify: slot: true	Enables slot notifications.
notify: slot: false	Disables slot notifications.
notify: remote: true	Enables remote notifications.
notify: remote: false	Disables remote notifications.
notify: configuration: true	Enables configuration notifications.
notify: configuration: false	Disables configuration notifications.
notify: dropped frames: true	Enables dropped frames notifications.
notify: dropped frames: false	Disables dropped frames notifications.
device info	Provides device information.
slot info: slot id: {slot ID}	Provides information about a specified slot.
transport info	Provides information for the state of the transport.
configuration	Queries the current configuration.
configuration: record mode: Duplicate	Configures the record mode to duplicate.
configuration: record mode: SingleDisk	Configures the record mode to single disk.

Command	Command Description
configuration: record mode: DiskOverwrite	Configures the record mode to disk overwrite.
configuration: video input: {"SDI", "optical"}	Configures video input.
configuration: file format: {format}	Configures the record codec and bit rate.
format: prepare: {format}	prepare a disk formatting operation to filesystem {format}
format: confirm: {token}	perform a pre-prepared formatting operation using token
watchdog: period: {seconds}	Configures the watchdog.

Using XML

Sie können die Benutzerstation verwenden, um mit dem HyperDeck zu kommunizieren. Sollten Sie Software schreiben, können Sie abhängig von der HyperDeck Firmware in XML das Bestehen von bestimmten Befehlen bestätigen. Das ist hilfreich, um die Benutzeroberfläche Ihrer Software an die Fähigkeiten des jeweiligen HyperDeck Modells und der Softwareversion anzupassen.

Protocol Details

Connection

The HyperDeck Ethernet server listens on TCP port 9993.

Basic syntax

The HyperDeck protocol is a line oriented text protocol. Lines from the server will be separated by an ascii CR LF sequence. Messages from the client may be separated by LF or CR LF.

New lines are represented in this document as a "↵" symbol.

Command syntax

Command parameters are usually optional. A command with no parameters is terminated with a new line:

```
{Command name}↵
```

If parameters are specified, the command name is followed by a colon, then pairs of parameter names and values. Each parameter name is terminated with a colon character:

```
{Command name}: {Parameter}: {Value} {Parameter}: {Value} ...↵
```

Response syntax

Simple responses from the server consist of a three digit response code and descriptive text terminated by a new line:

```
{Response code} {Response text}↵
```

If a response carries parameters, the response text is terminated with a colon, and parameter name and value pairs follow on subsequent lines until a blank line is returned:

```
{Response code} {Response text}:↵
```

```
{Parameter}: {Value}↵
```

```
{Parameter}: {Value}↵
```

```
...
```

```
↵
```

Successful response codes

A simple acknowledgement of a command is indicated with a response code of 200:

```
200 ok↵
```

Other successful responses carry parameters and are indicated with response codes in the range of 201 to 299.

Failure response codes

Failure responses to commands are indicated with response codes in the range of 100 to 199:

```
100 syntax error
101 unsupported parameter
102 invalid value
103 unsupported
104 disk full
105 no disk
106 disk error
109 out of range
110 no input
111 remote control disabled
120 connection rejected
150 invalid state
```

Asynchronous response codes

The server may return asynchronous messages at any time. These responses are indicated with response codes in the range of 500 to 599:

```
5xx {Response Text}:↵
{Parameter}: {Value}↵
{Parameter}: {Value}↵
↵
```

Connection response

On connection, an asynchronous message will be delivered:

```
500 connection info:↵
protocol version: {Version}↵
model: {Model Name}↵
↵
```

Connection rejection

Only one client may connect to the server at a time. If other clients attempt to connect concurrently, they will receive an error and be disconnected:

```
120 connection rejected↵
```

Timecode syntax

Timecodes are expressed as non-drop-frame timecode in the format:

```
HH:MM:SS:FF
```

Handling of deck "remote" state

The "remote" command may be used to enable or disable the remote control of the deck. Any attempt to change the deck state over ethernet while remote access is disabled will generate an error:

```
111 remote control disabled↵
```

To enable or disable remote control:

```
remote: enable: {"true", "false"} ↵
```

The current remote control state may be overridden allowing remote access over ethernet irrespective of the current remote control state:

```
remote: override: {"true", "false"} ↵
```

The override state is only valid for the currently connected ethernet client and only while the connection remains open.

The "remote" command may be used to query the remote control state of the deck by specifying no parameters:

```
remote↵
```

The deck will return the current remote control state:

```
210 remote info:↵
enabled: {"true", "false"}↵
override: {"true", "false"}↵
↵
```

Asynchronous remote control information change notification is disabled by default and may be configured with the "notify" command. When enabled, changes in remote state will generate a "510 remote info:" asynchronous message with the same parameters as the "210 remote info:" message.

Closing connection

The "quit" command instructs the server to cleanly shut down the connection:

```
quit↵
```

Checking connection status

The "ping" command has no function other than to determine if the server is responding:

```
ping↵
```

Getting help

The "help" or "?" commands return human readable help text describing all available commands and parameters:

```
help↵
```

or:

```
?↵
```

The server will respond with a list of all supported commands:

```
201 help:↵
{Help Text}↵
{Help Text}↵
↵
```

Stopping deck operation

The "stop" command instructs the deck to stop the current capture:

```
stop↵
```

Enumerating supported commands and parameters

The "commands" command returns the supported commands:

```
commands↵
```

The command list is returned in a computer readable XML format:

```
212 commands:
<commands>↵
    <command name="..."><parameter name="..."/>...</command>↵
    <command name="..."><parameter name="..."/>...</command>↵
    ...
</commands>↵
↵
```

More XML tokens and parameters may be added in later releases.

Controlling asynchronous notifications

The "notify" command may be used to enable or disable asynchronous notifications from the server. To enable or disable transport notifications:

```
notify: transport: {"true", "false"}↵
```

To enable or disable slot notifications:

```
notify: slot: {"true", "false"}↵
```

To enable or disable remote notifications:

```
notify: remote: {"true", "false"}↵
```

To enable or disable configuration notifications:

```
notify: configuration: {"true", "false"}↵
```

To enable or disable dropped frames notifications:

```
notify: dropped frames: {"true", "false"}↵
```

Multiple parameters may be specified. If no parameters are specified, the server returns the current state of all notifications:

```
209 notify:↵
transport: {"true", "false"}↵
slot: {"true", "false"}↵
remote: {"true", "false"}↵
configuration: {"true", "false"}↵
↵
```

Retrieving device information

The "device info" command returns information about the connected deck device:

```
device info↵
```

The server will respond with:

```
204 device info:↵
protocol version: {Version}↵
model: {Model Name}↵
unique id: {unique alphanumeric identifier}↵
↵
```

Example of response from server:

```
204 device info:↵
protocol version: 1.8↵
model: Blackmagic Duplicator 4K↵
unique id: 101112131415↵
↵
```

Retrieving slot information

The "slot info" command returns information about a slot.

The specified slot will be queried:

```
slot info: slot id: {Slot ID}↵
```

The server will respond with slot specific information:

```
202 slot info:↵
slot id: {Slot ID}↵
status: {"empty", "mounting", "error", "mounted"}↵
volume name: {Volume name}↵
recording time: {recording time available in seconds}↵
video format: {disk's default video format}↵
↵
```

Asynchronous slot information change notification is disabled by default and may be configured with the “notify” command. When enabled, changes in slot state will generate a “502 slot info:” asynchronous message with the same parameters as the “202 slot info:” message.

Retrieving transport information

The “transport info” command returns the state of the transport:

```
transport info ↵
```

The server responds with transport specific information:

```
208 transport info:↵  
status: {"stopped","record"}↵  
display timecode: {timecode}↵  
timecode: {timecode}↵
```

The “timecode” value is the timecode within the current timeline for playback or the clip for record. The “display timecode” is the timecode displayed on the front of the deck. The two timecodes will differ in some deck modes.

Asynchronous transport information change notification is disabled by default and may be configured with the “notify” command. When enabled, changes in transport state will generate a “508 transport info:” asynchronous message with the same parameters as the “208 transport info:” message.

Video Formats

The following video formats are currently supported on Blackmagic Duplicator 4K:

SD

525i59.94 NTSC

625i50 PAL

HD

720p50	1080p30
720p59.94	1080i50
720p60	1080p50
1080p23.98	1080i59.94
1080p24	1080p59.94
1080p25	1080i60
1080p29.97	1080p60

Ultra HD

2160p23.98	2160p30
2160p24	2160p50
2160p25	2160p59.94
2160p29.97	2160p60

Duplicator 4K supports progressive segmented frame modes, and automatically detects level A and level B 3G-SDI formats for 1080p50, 1080p59.94 and 1080p60.

File Formats

Duplicator 4K supports the following file formats:

- H.264Low
- H.264Medium
- H.264High
- H.265Low
- H.265Medium
- H.265High

Querying and updating configuration information

The "configuration" command may be used to query the current configuration of the deck:

```
configuration↵
```

The server returns the configuration of the deck:

```
211 configuration:↵  
video input: {"SDI", "optical"}↵  
↵
```

One or more configuration parameters may be specified to change the configuration of the deck.

To change the current video input:

```
configuration: video input: {"SDI", "optical"}↵
```

Configuring the watchdog

The "watchdog" command instructs the deck to monitor the connected client and terminate the connection if the client is inactive for at least a specified period of time.

To configure the watchdog:

```
watchdog: period: {period in seconds}↵
```

To avoid disconnection, the client must send a command to the server at least every [period] seconds. Note that if the period is set to 0 or less than 0, connection monitoring will be disabled.

Configuring the record mode

Use the 'record mode' command to select the deck recording mode:

```
configuration: record mode: {"Duplicate", "SingleDisk", "DiskOverwrite"}↵
```

Configuring the file format

The 'file format' command instructs the deck to switch to a specific file format for codec and bit rate:

```
configuration: file format: {"H.264High", "H.264Medium", "H.264Low",  
"H.265High", "H.265Medium", "H.265Low"}↵
```

Hilfe

Hilfestellung

Am schnellsten erhalten Sie Hilfe online über die Support-Seiten der Website von Blackmagic Design. Sehen Sie dort nach dem aktuellsten Support-Material für Ihren Blackmagic Duplicator 4K.

Blackmagic Design Online Support Seiten

Die aktuellsten Versionen der Bedienungsanleitung, Produktsoftware und der Support-Hinweise finden Sie im Blackmagic Support Center unter <https://www.blackmagicdesign.com/de/support>.

Blackmagic Design Forum

Das Blackmagic Design Forum auf unserer Website ist eine praktische Ressource, das Sie für mehr Information und kreative Ideen aufsuchen können. Manchmal finden Sie dort schnellere Lösungen, da möglicherweise bereits Antworten auf ähnliche Fragen von anderen erfahrenen Anwendern und Blackmagic Design Mitarbeitern vorliegen, die Ihnen weiterhelfen. Das Forum finden Sie unter <http://forum.blackmagicdesign.com>.

Kontaktaufnahme mit Blackmagic Design Support

Wenn unser Support-Material oder das Forum Ihnen nicht wie gewünscht hilft, gehen Sie bitte auf unsere Support-Seite und schicken Sie uns Ihre Anfrage über „Senden Sie uns eine E-Mail“. Oder klicken Sie auf „Finden Sie Ihr lokales Support-Team“ und rufen Sie Ihre nächstgelegene Blackmagic Design Support Stelle an.

Überprüfen der aktuell installierten Softwareversion

Um zu überprüfen, welche Version von Blackmagic Duplicator Utility auf Ihrem Computer installiert ist, öffnen Sie das Fenster „About Blackmagic Duplicator Utility“.

- Öffnen Sie Blackmagic Duplicator Utility auf macOS über den Ordner „Programme“. Um die Versionsnummer anzuzeigen, wählen Sie im Anwendungsmenü „About Blackmagic Duplicator Utility“ aus.
- Öffnen Sie Blackmagic Duplicator Utility auf Windows 8.1 von der Kachel „Blackmagic Duplicator Utility“ auf der Startseite. Um die Versionsnummer anzuzeigen, klicken Sie auf das Menü „Hilfe“ und wählen Sie „About Blackmagic Duplicator Utility“ aus.
- Öffnen Sie Blackmagic Duplicator Utility auf Windows 10 über das Startmenü. Um die Versionsnummer anzuzeigen, klicken Sie auf das Menü „Hilfe“ und wählen Sie „About Blackmagic Duplicator Utility“ aus.

So erhalten Sie die aktuellsten Software-Updates

Prüfen Sie zunächst die Versionsnummer der auf Ihrem Computer installierten Blackmagic Duplicator Utility Software. Sehen Sie dann im Blackmagic Design Support Center unter <https://www.blackmagicdesign.com/de/support> nach den neuesten Aktualisierungen. In der Regel empfiehlt es sich, die neuesten Updates zu laden. Vermeiden Sie jedoch Software-Updates mitten in einem wichtigen Projekt.

Gesetzliche Vorschriften und Sicherheitshinweise

Gesetzliche Vorschriften

Entsorgung von elektrischen und elektronischen Geräten innerhalb der Europäischen Union.



Das auf dem Produkt abgebildete Symbol weist darauf hin, dass dieses Gerät nicht zusammen mit anderen Abfallstoffen entsorgt werden darf. Altgeräte müssen daher zur Wiederverwertung an eine dafür vorgesehene Sammelstelle übergeben werden. Mülltrennung und Wiederverwertung von Altgeräten tragen zum nachhaltigen Umgang mit natürlichen Ressourcen bei. Gleichzeitig wird sichergestellt, dass die Wiederverwertung nicht zulasten der menschlichen Gesundheit und der Umwelt geht. Weitere Informationen zur Entsorgung von Altgeräten sowie zu den Standorten der zuständigen Sammelstellen erhalten Sie von Ihren örtlichen Müllentsorgungsbetrieben sowie vom Händler, bei dem Sie dieses Produkt erworben haben.



Dieses Gerät wurde geprüft und entspricht den Grenzwerten für Digitalgeräte der Klasse A gemäß Abschnitt 15 der FCC-Bestimmungen für Funkstörung. Diese Grenzwerte dienen dem angemessenen Schutz gegen schädliche Störungen bei Betrieb des Geräts in einem gewerblichen Umfeld. Geräte dieser Art erzeugen und verwenden Hochfrequenzen und können diese auch ausstrahlen. Bei Nichteinhaltung der Installations- und Gebrauchsvorschriften können sie zu Störungen beim Rundfunkempfang führen. Der Betrieb solcher Geräte im Wohnbereich führt mit großer Wahrscheinlichkeit zu Funkstörungen. In diesem Fall kann vom Betreiber verlangt werden, selbst für die Beseitigung solcher Störungen aufzukommen.

Der Betrieb unterliegt den folgenden zwei Bedingungen:

- 1 Dieses Gerät darf keine schädigenden Störungen hervorrufen.
- 2 Dieses Gerät muss allen Störungen standhalten, einschließlich Störungen, die einen unerwünschten Betrieb zur Folge haben.

ISED Canada Statement

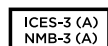

Dieses Gerät erfüllt die kanadischen Vorschriften für digitale Geräte der Klasse A. Jedwede an diesem Produkt vorgenommene unsachgemäße Änderung kann die Konformitätserklärung zum Erlöschen bringen.

Dieses Gerät wurde geprüft und erfüllt die Bestimmungen zum Einsatz in einem gewerblichen Umfeld. Bei Einsatz des Geräts in einer häuslichen Umgebung verursacht es möglicherweise Funkstörungen

Sicherheitshinweise

Zum Schutz vor Stromschlag muss das Gerät an ein vorschriftsmäßig geerdetes Stromnetz angeschlossen werden. Kontaktieren Sie im Zweifelsfall einen Elektrofachmann.

Um das Risiko eines Stromschlags zu verringern, setzen Sie das Gerät weder Tropfen noch Spritzern aus.

Das Produkt eignet sich für den Einsatz in tropischen Gebieten mit einer Umgebungstemperatur von bis zu 40 °C.

Achten Sie auf eine ausreichende Luftzufuhr um das Gerät herum, damit die Belüftung nicht eingeschränkt wird.

Achten Sie bei der Installation im Rack darauf, dass die Luftzufuhr nicht durch andere Geräte eingeschränkt wird.

Es befinden sich keine durch den Anwender zu wartenden Teile im Inneren des Produkts. Wenden Sie sich für die Wartung an ein Blackmagic Design Service-Center in Ihrer Nähe.

Einige Produkte verfügen über einen Steckplatz für einen kleinen SFP-Transceiver (Small Form Pluggable Sende-/Empfangsgerät) für ein Glasfasermodul. Es dürfen nur SFP-Glasfasermodule der Laserklasse 1 eingesetzt werden.

Blackmagic Design empfiehlt die nachstehenden SFP-Module:

- **3G-SDI:** PL-4F20-311C
- **6G-SDI:** PL-8F10-311C
- **12G-SDI:** PL-TG10-311C



Nur in Höhen bis 2000 m über dem Meeresspiegel einsetzen.

California Proposition 65

Es ist möglich, dass dieses Produkt Sie Chemikalien wie sechswertigem Chrom aussetzt. Im US-amerikanischen Bundesstaat Kalifornien wird es mit Krebs, Geburtsfehlern und anderen Schäden am Fortpflanzungssystem in Verbindung gebracht.

Weitere Informationen finden Sie unter www.P65Warnings.ca.gov.

Warnhinweise für autorisiertes Wartungspersonal

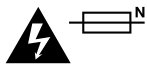

Vorsicht – Doppelpol/Neutrale Sicherung

Die in diesem Gerät enthaltenen Außen- und Neutralleiter sind beide durch eine Sicherung geschützt. Daher ist das Gerät für den Anschluss an das IT-Energieverteilungssystem in Norwegen geeignet.

Garantie

12 Monate eingeschränkte Garantie

Die Firma Blackmagic Design gewährt eine Garantie auf Material- und Verarbeitungsfehler des Blackmagic Duplicator 4K von 12 Monaten ab Kaufdatum. Sollte sich ein Produkt innerhalb dieser Garantiezeit als fehlerhaft erweisen, wird die Firma Blackmagic Design nach ihrem Ermessen das defekte Produkt entweder ohne Kostenerhebung für Teile und Arbeitszeit reparieren oder Ihnen das defekte Produkt ersetzen.

Zur Inanspruchnahme der Garantieleistungen müssen Sie als Kunde Blackmagic Design über den Defekt innerhalb der Garantiezeit in Kenntnis setzen und die entsprechenden Vorkehrungen für die Leistungserbringung treffen. Es obliegt dem Kunden, für die Verpackung und den bezahlten Versand des defekten Produkts an ein spezielles von Blackmagic Design benanntes Service Center zu sorgen und hierfür aufzukommen. Sämtliche Versandkosten, Versicherungen, Zölle, Steuern und sonstige Ausgaben im Zusammenhang mit der Rücksendung von Waren an uns, ungeachtet des Grundes, sind vom Kunden zu tragen.

Diese Garantie gilt nicht für Mängel, Fehler oder Schäden, die durch unsachgemäße Handhabung oder unsachgemäße oder unzureichende Wartung und Pflege verursacht wurden. Blackmagic Design ist im Rahmen dieser Garantie nicht verpflichtet, die folgenden Serviceleistungen zu erbringen: a) Behebung von Schäden infolge von Versuchen Dritter, die Installation, Reparatur oder Wartung des Produkts vorzunehmen, b) Behebung von Schäden aufgrund von unsachgemäßer Handhabung oder Anschluss an nicht kompatible Geräte, c) Behebung von Schäden oder Störungen, die durch die Verwendung von nicht Blackmagic-Design-Ersatzteilen oder -Verbrauchsmaterialien entstanden sind, d) Service für ein Produkt, das verändert oder in andere Produkte integriert wurde, sofern eine solche Änderung oder Integration zu einer Erhöhung des Zeitaufwands oder zu Schwierigkeiten bei der Wartung des Produkts führt. ÜBER DIE IN DIESER GARANTIEERKLÄRUNG AUSDRÜCKLICH AUFGEFÜHRTEN ANSPRÜCHE HINAUS ÜBERNIMMT BLACKMAGIC DESIGN KEINE WEITEREN GARANTIEEN, WEDER AUSDRÜCKLICH NOCH STILLSCHWEIGEND. DIE FIRMA BLACKMAGIC DESIGN UND IHRE HÄNDLER LEHNEN JEGLICHE STILLSCHWEIGENDEN GARANTIEEN IN BEZUG AUF AUSSAGEN ZUR MARKTGÄNGIGKEIT UND GEBRAUCHSTAUGLICHKEIT FÜR EINEN BESTIMMTEN ZWECK AB. DIE VERANTWORTUNG VON BLACKMAGIC DESIGN, FEHLERHAFTEN PRODUKTEN ZU REPARIEREN ODER ZU ERSETZEN, IST DIE EINZIGE UND AUSSCHLIESSLICHE ABHILFE, DIE GEGENÜBER DEM KUNDEN FÜR ALLE INDIREKTEN, SPEZIELLEN, NEBEN- ODER FOLGESCHÄDEN ZUR VERFÜGUNG GESTELLT WIRD, UNABHÄNGIG DAVON, OB BLACKMAGIC DESIGN ODER DER HÄNDLER VON DER MÖGLICHKEIT SOLCHER SCHÄDEN ZUVOR IN KENNTNIS GESETZT WURDE. BLACKMAGIC DESIGN IST NICHT HAFTBAR FÜR JEGLICHE WIDERRECHTLICHE VERWENDUNG DER GERÄTE DURCH DEN KUNDEN. BLACKMAGIC HAFTET NICHT FÜR SCHÄDEN, DIE SICH AUS DER VERWENDUNG DES PRODUKTS ERGEBEN. NUTZUNG DES PRODUKTS AUF EIGENE GEFAHR.

© Copyright 2019 Blackmagic Design. Alle Rechte vorbehalten. „Blackmagic Design“, „DeckLink“, „HDLink“, „Workgroup Videohub“, „Videohub“, „DeckLink“, „Intensity“ und „Leading the creative video revolution“ sind in den USA und in anderen Ländern eingetragene Warenzeichen. Alle anderen Unternehmens- und Produktnamen sind möglicherweise Warenzeichen der jeweiligen Firmen, mit denen sie verbunden sind. Thunderbolt und das Thunderbolt-Logo sind Warenzeichen der Firma Intel Corporation in den USA bzw. in anderen Ländern.



Manual de instalación y funcionamiento

Blackmagic Duplicator 4K

Febrero 2019

Español



Bienvenido

Gracias por haber adquirido este producto.

Estamos muy entusiasmados con el nuevo Blackmagic Duplicator 4K y creemos que es la solución ideal para distribuir contenidos de alta calidad en definición UHD. Este dispositivo facilita la copia de material audiovisual en 25 tarjetas SD simultáneamente y es compatible con distintas definiciones hasta una resolución máxima de 2160p60. El sistema de compresión H.265 brinda una nitidez excepcional con una mayor frecuencia de imagen y no requiere grandes velocidades de transferencia, de modo que es posible emplear unidades de almacenamiento económicas y prolongar la duración de la grabación.

Este equipo es muy fácil de usar. El panel frontal cuenta con una pantalla de cristal líquido que permite modificar diferentes ajustes. Asimismo, la unidad puede operarse mediante los botones integrados o de forma remota, a través de una red Ethernet o conectándola a un controlador RS-422. Incluso es posible crear soluciones personalizadas y controlar el dispositivo mediante el protocolo Blackmagic HyperDeck.

Por su parte, el codificador H.265 brinda la posibilidad de grabar imágenes extraordinarias en tarjetas SD de bajo precio, facilitando de este modo la copia de contenidos UHD sin necesidad de recurrir a equipos costosos. La versión 1.2 del software interno del dispositivo permite grabar archivos H.264, brindando así una mayor compatibilidad.

Este producto tiene una altura de una unidad de bastidor, lo que permite conectar varios dispositivos en serie al instalarlos en bastidores portátiles, a fin de ofrecer una solución para grabar en cientos de tarjetas al mismo tiempo.

Este manual de instrucciones contiene toda la información necesaria para comenzar a utilizar el dispositivo.

En la página de soporte técnico de nuestro sitio web encontrarás su versión más reciente, así como actualizaciones para el software interno de este producto. Al mantenerlo actualizado, siempre podrás contar con las prestaciones más recientes. Por último, no olvides registrarte al descargar las actualizaciones para que podamos mantenerte informado sobre nuevos lanzamientos. Trabajamos constantemente para desarrollar herramientas innovadoras y superarnos, de modo que nos encantaría conocer tu opinión.

Grant Petty

Director ejecutivo de Blackmagic Design

Índice

Blackmagic Duplicator 4K

Primeros pasos	153
Conexión del cable de alimentación	153
Conexión de fuentes	153
Conexión en serie	154
Uso de tarjetas de memoria	155
Grabación	156
Configuración del modo de grabación	156
Configuración del códec	158
Ajuste de la velocidad de transmisión	158
Grabación de contenidos	159
Indicadores de estado	159
Grabación en un mismo archivo	160
Bloqueo del dispositivo	161
Conexión de varias unidades en serie	162
Menú de ajustes	163
Grabación	163
Ajustes	168
Menú <i>About</i>	169
Blackmagic Duplicator Utility	169
Actualización del dispositivo	169
Prefijo del nombre de archivo	170
Instalación de un módulo SDI opcional para fibra óptica	170
Protocolo de control RS-422	171
¿Qué es el estándar RS-422?	171
Uso de un controlador RS-422 externo	172
RS-422 Developer Information	174
Control a distancia mediante redes Ethernet	174
Ejemplo de control mediante microprocesador Arduino	175
Protocolo de Ethernet para el modelo Blackmagic HyperDeck	177
Protocol Commands	177
Protocol Details	178
Configuring the watchdog	183
Configuring the record mode	183
Configuring the file format	183
Ayuda	184
Normativas	185
Seguridad	186
Garantía	187

Primeros pasos

Es muy fácil comenzar a utilizar el dispositivo.

Solo es necesario conectarlo a una red de suministro eléctrico, seleccionar la fuente SDI e insertar hasta 25 tarjetas de memoria. Asimismo, es posible emplear varias unidades para grabar contenidos en tarjetas adicionales. Basta con conectarlas en serie a fin de obtener una mayor cantidad de ranuras para soportes de almacenamiento. Esta sección del manual explica cómo configurar el dispositivo para poder empezar a copiar material audiovisual de inmediato.

Conexión del cable de alimentación

Para suministrarle energía eléctrica al dispositivo, simplemente conecte un cable de alimentación IEC convencional a la entrada para corriente alterna de 110-240 V situada en el panel trasero.

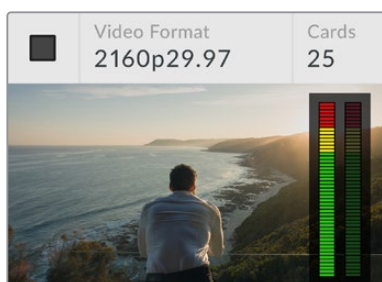

Al encender el equipo, se visualiza la fuente conectada en la pantalla LCD.

Pantalla de inicio

La pantalla de inicio permite ver la imagen correspondiente a la fuente conectada, la cantidad de tarjetas insertadas en el dispositivo y un indicador de grabación, además de un vúmetro digital que brinda información sobre la intensidad del volumen.

Conexión de fuentes

Conecte una fuente a la entrada SDI 12G situada en la parte posterior del dispositivo. El formato de la señal entrante se detecta automáticamente y se indica en la pantalla LCD.

Las distintas opciones de conectividad que ofrece el equipo permiten utilizar materiales audiovisuales en SD, HD y UHD con una resolución máxima de 2160p60 y transmitirlos a través de un solo cable BNC. De este modo, el formato de la señal que se emite mediante la salida derivada siempre coincide con el del contenido original, lo cual permite conectar otras unidades o equipos SDI. Asimismo, es compatible con modos de fotogramas segmentados progresivos (PsF) y detecta automáticamente señales SDI 3G nivel A y B a 1080p50, 1080p59.94 y 1080p60.

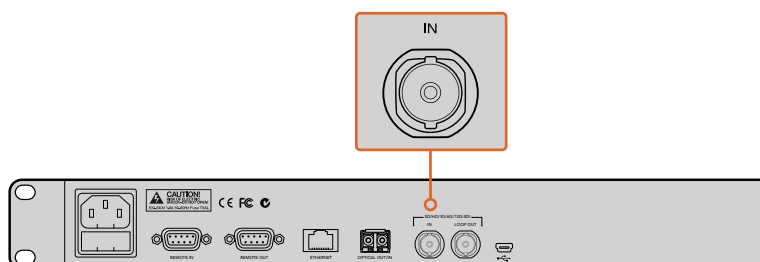

Conecte el equipo de origen a la entrada SDI. El audio está integrado en la señal.

El dispositivo es capaz de procesar dos canales de audio integrados en la señal SDI, de manera que no es necesario conectar fuentes adicionales.

SUGERENCIA: Es posible monitorizar la intensidad del volumen en la pantalla de inicio.

Conexión en serie

Es posible conectar varias unidades en serie a fin de obtener una mayor capacidad de grabación. Por ejemplo, si se necesita copiar 100 tarjetas, basta con emplear cuatro dispositivos simultáneamente.

- 1 Conecte la salida RS-422 de la primera unidad a la entrada correspondiente de la segunda unidad. Repita este mismo procedimiento para cada dispositivo que vaya a utilizar.
- 2 De manera similar, conecte la salida derivada SDI de la primera unidad a la entrada correspondiente de la segunda unidad. Repita este procedimiento para los dispositivos restantes.
- 3 En el panel de control de cada unidad hay un botón denominado **REM**. Es preciso activarlo para poder controlar las todas las unidades en forma remota. Presione este botón en todas las unidades conectadas, a excepción de la primera.

NOTA: Compruebe que el botón **REM** no se encuentre encendido en la unidad principal, ya que esta controla a todos los demás dispositivos conectados en serie. Cualquier modificación que se realice en dicha unidad afectará a todas aquellas en las que el botón **REM** esté encendido. Todo dispositivo compatible con el protocolo de control RS-422 puede actuar como unidad principal, dado que el formato utilizado es convencional.

Luego de realizar este procedimiento, todas las unidades conectadas podrán controlarse mediante la unidad principal.

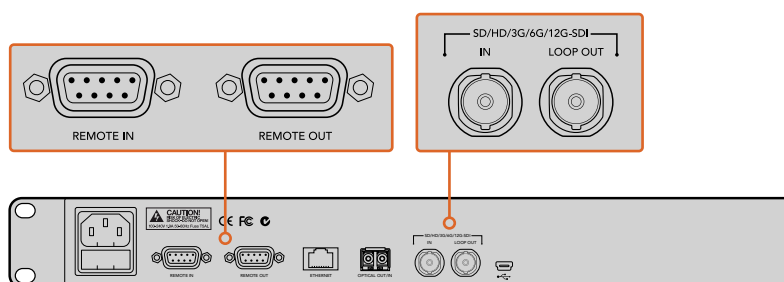

Las conexiones **REMOTE** y **LOOP** se emplean para conectar varias unidades en serie. La conexión derivada de la última unidad puede utilizarse para transmitir la señal a otros equipos SDI, tales como los monitores SmartView o el grabador digital HyperDeck de Blackmagic.

Para obtener más información al respecto, consulte el apartado *Conexión de varias unidades en serie*.

Uso de tarjetas de memoria

El equipo es compatible con tarjetas de memoria SD convencionales (clase 10). Estas pueden adquirirse en cualquier tienda que venda productos para cámaras e incluso en algunos supermercados.

SUGERENCIA: En la etiqueta de las tarjetas de memoria podrá notar un número del 1 al 10 dentro de un círculo pequeño que indica la velocidad de la unidad. Cualquier tarjeta clase 10 permite almacenar imágenes en UHD utilizando la mayor velocidad de transmisión posible.

Cómo insertar una tarjeta de memoria

- 1 Sostenga la unidad con los contactos dorados orientados hacia el panel de control, de forma que coincida con una de las ranuras correspondientes en el dispositivo.
- 2 Empuje la tarjeta con suavidad hasta que calce firmemente en su lugar. El dispositivo Blackmagic Duplicator 4K la verificará rápidamente y, cuando esté preparada para grabar el indicador encima de la ranura, se encenderá de color verde.

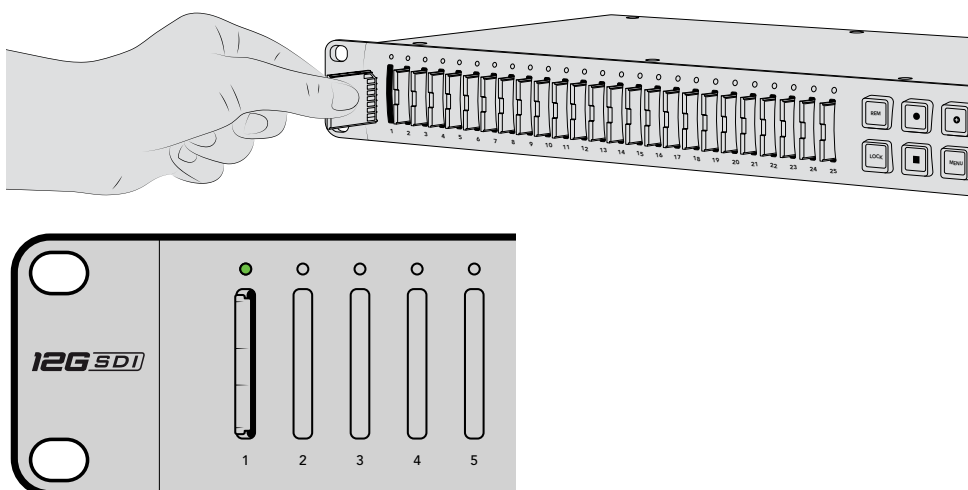

Coloque la tarjeta de memoria frente a una de las ranuras con los contactos dorados orientados hacia esta y empújela con suavidad hasta que calce en su lugar. El indicador correspondiente se encenderá de color verde para indicar que la tarjeta está preparada para la grabación.

Para quitar la tarjeta, tómelala del borde con cuidado y retírela de la ranura.

SUGERENCIA: Al insertar una tarjeta, compruebe que no se encuentre protegida. La protección contra la escritura de datos puede inhabilitarse moviendo el pequeño interruptor situado en el lado izquierdo de la unidad hacia la posición más cercana a los conectores. Luego de copiar contenidos, puede proteger la tarjeta nuevamente desplazando el interruptor hacia su posición original.

Preparación de las tarjetas

Antes de comenzar a grabar, es necesario dar formato a las tarjetas utilizando el sistema exFAT. Este último es compatible con sistemas operativos macOS y Windows. La función **Format** del dispositivo permite formatear hasta 25 unidades simultáneamente con rapidez y facilidad.

Para formatear tarjetas de memoria, siga los pasos descritos a continuación:

- 1 Presione el botón **MENU** en el panel de control.
- 2 Seleccione la opción **Record** oprimiendo el botón contextual situado junto a la misma.
- 3 Presione el botón correspondiente a la flecha izquierda para escoger la opción **Format Cards** y luego seleccione **Format**.
- 4 Aparecerá un aviso de advertencia para confirmar el formato. Presione el botón situado junto a la opción **Format** para confirmar o seleccione **Cancel** para cancelar.
- 5 Una barra indicará el avance del proceso. Al finalizar, presione el botón junto a la opción **OK**.
- 6 Presione el botón **MENU** en el panel de control para regresar a la pantalla de inicio.

Esto es todo lo que necesita saber para utilizar el dispositivo. Luego de conectar las fuentes y dar formato a las tarjetas de memoria, el equipo estará listo para comenzar la grabación.

SUGERENCIA: Nótese que la rapidez de este procedimiento puede variar en función del tipo de tarjeta empleada.

Grabación

Para comenzar a copiar contenidos inmediatamente, presione el botón de grabación en el panel de control. Sin embargo, recomendamos ajustar el modo de grabación, el códec y la velocidad de transmisión en primer lugar, ya que determina el tipo, la duración y la calidad del material grabado.

Configuración del modo de grabación

El dispositivo Blackmagic Duplicator 4K ofrece los siguientes modos de grabación:

- **Duplicado:** La opción **Duplicate** graba en todas las tarjetas SD simultáneamente.
- **Individual:** La opción **Single Disk** graba en una sola tarjeta SD a la vez y detiene el proceso cuando la última está llena.
- **Sobrescritura:** La opción **Disk Overwrite** graba en una sola tarjeta a la vez y continúa el proceso sobrescribiendo el material de manera continua.

Modo duplicado

Esta opción graba el mismo contenido en todas las tarjetas SD al mismo tiempo.

Modo individual

El modelo Blackmagic Duplicator 4K es una grabadora excepcional que ofrece una gran variedad de aplicaciones para transmisiones de televisión o incluso cámaras de seguridad. Esta opción comienza la grabación en una tarjeta y, cuando esta se llena, continúa en la siguiente. Así sucesivamente hasta que las unidades no tienen más espacio de almacenamiento. Sin embargo, como el equipo cuenta con 25 ranuras, es posible grabar durante períodos de tiempo prolongados. Para lograr una grabación continua e ininterrumpida, se pueden cambiar las tarjetas llenas por otras vacías en cualquier momento.

En caso de contar con múltiples unidades conectadas en serie, será posible grabar durante más tiempo, ya que, cuando todas las tarjetas del dispositivo maestro están llenas, el proceso continuará en los soportes de almacenamiento de la primera unidad esclava conectada. La grabación se detendrá cuando las tarjetas en la última unidad estén llenas.

Modo de sobrescritura

Esta opción permite a una sola unidad Blackmagic Duplicator 4K con dos o más tarjetas SD volver a grabar sobre la primera cuando la última está llena, de este modo no se interrumpe el proceso. La grabación se realiza en una tarjeta a la vez. Cuando a esta no le queda espacio, se formatea y continúa en la siguiente disponible.

Este modo es similar al de grabación individual, excepto porque cuando la última tarjeta está llena, se formatean y sobrescriben en vez de detener el proceso. Con esta opción seleccionada, la unidad continuará grabando indefinidamente hasta que se presione el botón para detenerla.

SUGERENCIA: Con el modo de grabación individual o de sobrescritura, es posible insertar tarjetas SD vacías en cualquier momento. El dispositivo continuará grabando siempre que haya unidades con espacio disponible en cualquiera de las 25 ranuras.

Para configurar un modo de grabación:

- 1 Encienda la unidad Blackmagic Duplicator 4K.
- 2 Presione el botón **MENU** en el panel de control para acceder a los ajustes. Los botones contextuales junto a la pantalla se iluminarán para indicar a qué opciones del menú corresponden. Presione el botón contextual **Record**.

El menú de grabación muestra una serie de puntos en la parte inferior que indican la cantidad de opciones disponibles. Para volver al menú anterior en cualquier momento, presione el botón contextual **Back**. Utilice los botones contextuales que corresponden a las flechas para desplazarse por las opciones.
- 3 Seleccione el menú **Mode** presionando el botón contextual **Change**.
- 4 Presione el botón contextual **Set** para seleccionar el modo que se muestra en la pantalla. La opción seleccionada se encenderá de color azul en la pantalla.
- 5 Presione el botón **MENU** para regresar a la pantalla de inicio y ver el modo de grabación seleccionado.

Consulte el apartado *Conexión de varias unidades en serie* para obtener más información al respecto.

SUGERENCIA: Si se está grabando un evento importante empleando el modo individual o de sobrescritura y desea extraer una tarjeta SD sin tener que esperar hasta que la actual se llene, basta con mantener presionado el botón de grabación durante tres segundos y la grabación continuará en la siguiente unidad. Al grabar en el modo de duplicado, presione el botón **+** en el panel de control. Consulte el apartado *Grabación en un mismo archivo* para obtener más información al respecto.

Configuración del códec

El dispositivo permite grabar archivos utilizando los sistemas de compresión H.264 o H.265. En forma predeterminada, el dispositivo graba en H.264.

Para cambiar el códec:

- 1 Presione el botón **MENU**.
- 2 Presione el botón contextual correspondiente a la opción **Record** para acceder a las opciones de grabación.
- 3 Utilice los botones situados junto a las flechas para acceder a la opción **Codec** y seleccione **Change**.
- 4 Seleccione el ajuste deseado y luego presione el botón correspondiente a la opción **Set** para confirmar, o el botón **MENU** en el panel de control para confirmar los cambios y volver a la pantalla de inicio.

NOTA: Deberá actualizar el software interno del dispositivo a la versión 1.1 o posterior para poder realizar cambios en el códec. Consulte el apartado correspondiente en este manual para obtener más información al respecto.

Cómo escoger el códec adecuado:

Para obtener una mayor compatibilidad, recomendamos seleccionar el sistema H.264. Este es el motivo por el cual hemos escogido esta opción para la configuración predeterminada del dispositivo.

El códec H.265 es ideal para grabar imágenes UHD en archivos de menor tamaño, pero al ser un sistema muy reciente, la compatibilidad con equipos informáticos o de reproducción podría ser menor.

Ambos códecs tienen ventajas. Al emplear el formato H.265, podrá almacenar el contenido en tarjetas SD más económicas, puesto que la velocidad de transmisión y el tamaño de los archivos para una determinada calidad de la imagen será menor. Por su parte, el sistema H.264 es la mejor opción si su proyecto requiere una mayor compatibilidad.

Ajuste de la velocidad de transmisión

El dispositivo ofrece tres ajustes diferentes para la velocidad de transmisión. Estos permiten establecer la cantidad de datos que el codificador H.265 procesa por segundo. La opción predeterminada es **Medium**, la cual brinda la posibilidad de obtener imágenes de alta calidad en archivos con un tamaño razonable. De todos modos, este parámetro se puede modificar fácilmente.

Para ajustar de la velocidad de transmisión:

- 1 Presione el botón **MENU**.
- 2 Presione el botón contextual correspondiente a la opción **Record** para acceder a las opciones de grabación.
- 3 Utilice los botones situados junto a las flechas para acceder a la opción **Bit Rate** y seleccione **Change**.
- 4 Seleccione el ajuste deseado y luego presione el botón correspondiente a la opción **Set** para confirmar, o el botón **MENU** en el panel de control para confirmar los cambios y retornar a la pantalla de inicio.

NOTA: Al emplear una mayor velocidad de transmisión se obtiene una mejor calidad. Sin embargo, esto disminuye la capacidad de almacenamiento y requiere el uso de tarjetas más costosas. Por el contrario, al utilizar una velocidad de transmisión menor es posible grabar una mayor cantidad de material audiovisual, pero la calidad de imagen puede resultar menor a la esperada.

Es aconsejable probar diferentes ajustes para lograr la calidad necesaria con el menor tamaño de archivo posible.

Grabación de contenidos

Para comenzar a copiar contenidos, simplemente presione el botón de grabación en el panel de control. Durante este proceso, la luz situada encima de cada ranura se enciende de color rojo. Una vez que el procedimiento haya finalizado exitosamente, volverá a encenderse de color verde, y el dispositivo está listo para grabar nuevamente. El material grabado puede verificarse con facilidad en cualquier equipo informático o en un televisor con tecnología HDMI que admita tarjetas de memoria en formato exFAT.

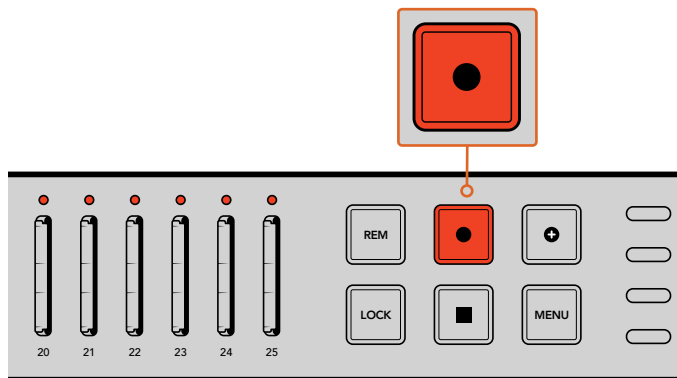



Presione el botón de grabación para comenzar a grabar. Las luces situadas encima de cada ranura se encienden de color rojo para indicar que la tarjeta insertada está en uso.

Indicadores de estado

Los indicadores situados encima de cada ranura se encienden de distintos colores para brindar información sobre su estado. Por ejemplo, al insertar una tarjeta de memoria, se prende una luz verde, lo cual significa que el dispositivo ha reconocido la unidad de almacenamiento y está listo para comenzar a grabar.

A continuación se proporciona una descripción de lo que representa cada color:

-  **Verde constante**
Lista para grabar. El indicador se enciende de color verde cuando la tarjeta está lista para la grabación.
-  **Rojo constante**
Grabando. El indicador se enciende de color rojo cuando se están grabando contenidos.
-  **Rojo intermitente**
El indicador parpadeará cuando quedan menos de 3 minutos de grabación disponibles en la tarjeta.



Rojo intermitente (rápido)

El indicador parpadeará rápidamente en color rojo cuando se estén omitiendo fotogramas. La velocidad de escritura de la tarjeta SD no es lo suficientemente rápida y no coincide con la de grabación.



Amarillo constante

Tarjeta llena, unidad protegida o error de grabación. Si durante el proceso de grabación el indicador permanece encendido en amarillo, puede ser por que la tarjeta esté en mal estado o protegida, que no haya sido formateada o que cuente con menos de 10 segundos de almacenamiento. Compruebe que el interruptor de bloqueo de la tarjeta se encuentre en la posición correcta, o intente modificar la velocidad de transmisión, formatear la unidad o cambiarla por una distinta.

Si bien el dispositivo tratará de mantener el sistema de archivos en cada tarjeta organizado y listo para su extracción, en caso de que esta se retire durante la grabación, procure evitar este procedimiento. Esto se debe a que algunos sistemas operativos empleados para visualizar el material almacenado son menos consistentes que otros y pueden considerar que el archivo se encuentra dañado. Por esta razón, siempre es recomendable detener la grabación antes de retirar la tarjeta. Si fuera necesario de todos modos traspasar el soporte de almacenamiento a otras personas antes de que finalice el espectáculo, es aconsejable utilizar varias unidades a fin de poder detener una de ellas y quitar las tarjetas mientras las demás continúan grabando.

SUGERENCIA: Aunque las tarjetas de memoria clase 10 permiten grabar datos en todas las velocidades de transmisión que ofrece el dispositivo, también es posible realizar la copia a una menor velocidad si se requiere utilizar unidades más económicas. Por ejemplo, al grabar imágenes tomadas por una cámara de seguridad, no es preciso obtener la mejor calidad. Recomendamos realizar una grabación de prueba previa para comprobar si la tarjeta utilizada es capaz de almacenar contenidos a la velocidad deseada. Para obtener más información al respecto, consulte el apartado *Uso de tarjetas de memoria* en este manual.

Grabación en un mismo archivo

Al emplear el modo de duplicado, en ocasiones, es necesario añadir un clip al material grabado con anterioridad a fin de obtener un solo archivo con todos los contenidos. Esto sucede, por ejemplo, durante la cobertura de espectáculos con distintos eventos independientes. La función **Append Record** facilita la incorporación de grabaciones posteriores al clip inicial en un mismo archivo.

- 1 Grabe el clip inicial como lo haría normalmente. Presione el botón de detención.
- 2 Cuando comience el siguiente evento, presione el botón + en el panel frontal. Este se encenderá junto con el botón de grabación para indicar que el material grabado se agregará al final del clip anterior.
- 3 Presione el botón de detención. El nuevo clip se añadirá al material grabado con anterioridad.

SUGERENCIA: Al utilizar esta función, es posible grabar tantos clips como sea necesario en un mismo archivo. Habrá que tener en cuenta el tamaño de la tarjeta y la duración del material.

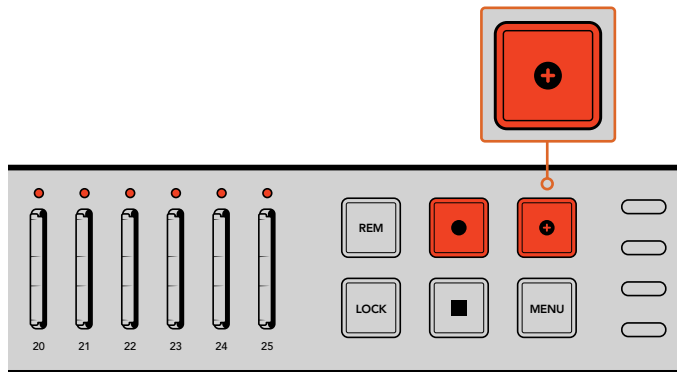

Presione el botón + en el panel frontal para añadir un nuevo clip al material grabado.

SUGERENCIA: Si se está empleando el modo de grabación individual o sobrescritura, es posible mantener presionado el botón de grabación durante tres segundos para que la grabación continúe en la siguiente unidad disponible. Esta opción es muy útil cuando no es posible detener la grabación y es necesario acceder a eventos importantes inmediatamente después de que hayan sucedido. Consulte el apartado *Configuración del modo de grabación* para obtener más información al respecto. Al grabar en el modo de duplicado, presione el botón + en el panel de control. Consulte el apartado *Grabación en un mismo archivo* para obtener más información al respecto.

Bloqueo del dispositivo

Durante eventos importantes, es recomendable bloquear el panel de control para impedir que la grabación se detenga accidentalmente. Asimismo, es útil repetir este procedimiento para cada unidad conectada en serie.

Esta función puede activarse o desactivarse mediante el botón **LOCK** en cada dispositivo. Es muy poco probable que una unidad se desbloquee fortuitamente, ya que para activar los controles es necesario presionar este botón durante dos segundos.

Para bloquear el dispositivo:

- 1 Presione el botón **LOCK** en panel de control del dispositivo.
- 2 Para desbloquear el dispositivo, mantenga presionado el botón **LOCK** durante dos segundos.

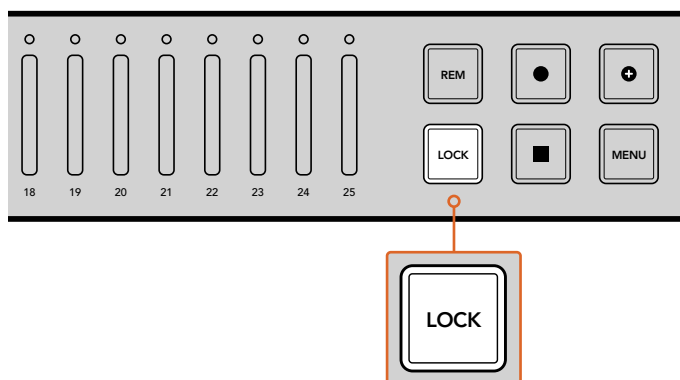

Bloquear los controles del dispositivo evita que se produzcan interrupciones en la grabación.

Conexión de varias unidades en serie

Es posible conectar varias unidades en serie a fin de obtener una mayor capacidad de grabación. En este caso, todos los dispositivos comparten la misma señal de video mediante las conexiones derivadas y pueden establecer una comunicación entre sí gracias al protocolo RS-422.

Para conectar varias unidades en serie:

- 1 Conecte la salida RS-422 de la primera unidad a la entrada correspondiente en la segunda mediante un cable serial con conectores DB-9. Este tipo de cables se consigue fácilmente en cualquier tienda de insumos informáticos o audiovisuales.
- 2 Conecte la salida SDI derivada de la primera unidad a la entrada SDI de la segunda.

Es así de sencillo. Para conectar unidades adicionales, basta con repetir este mismo procedimiento tantas veces como sea necesario.

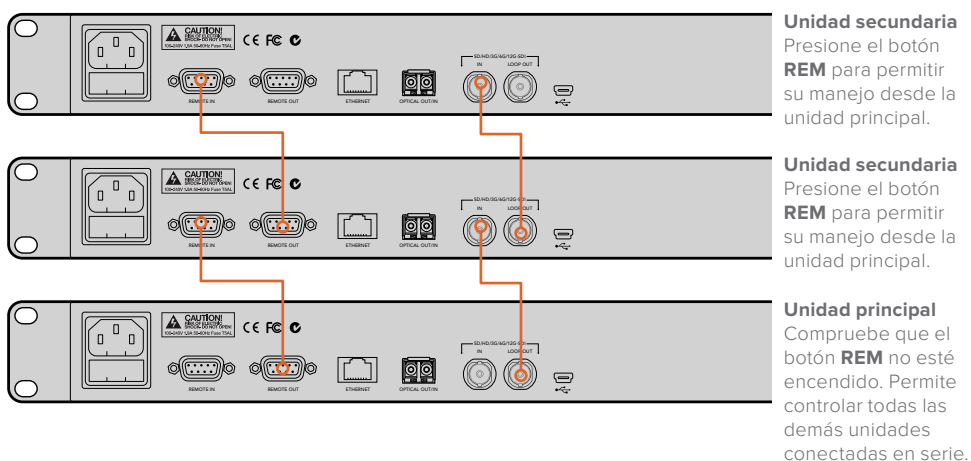

Para utilizar varias unidades simultáneamente, simplemente conecte la salida de una de ellas a la entrada SDI de otra. Repita este procedimiento para cada unidad.

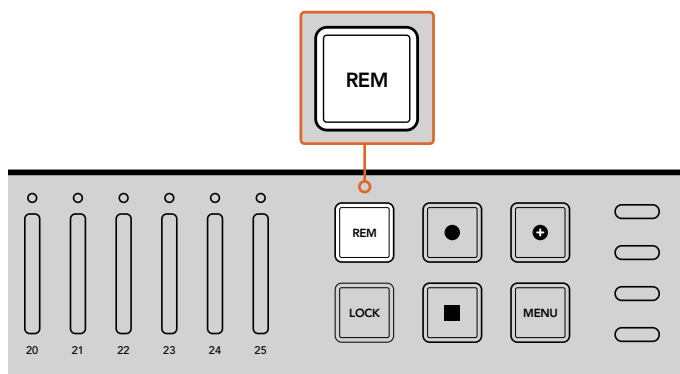

Presione el botón **REM** de cada unidad excepto la principal, de modo que todas puedan controlarse a través de esta.

NOTA: Asegúrese de presionar el botón **REM** en todas las unidades secundarias para permitir su manejo en forma remota. Compruebe que este se encuentre encendido. Oprímalo nuevamente para desactivar esta función.

Es recomendable realizar una grabación de prueba para comprobar que todos los dispositivos puedan controlarse mediante la unidad principal antes de proceder a la copia final. Si las unidades secundarias no responden, asegúrese de que el botón **REM** no esté presionado en la unidad principal y verifique que se encuentre encendido en todas las demás.

Menú de ajustes

Todos los ajustes del dispositivo pueden modificarse por medio de los menús visualizados en la pantalla frontal y los botones contextuales. Estos últimos se encuentran a ambos lados de la pantalla LCD y se encienden según las opciones que figuran en el menú correspondiente.

Para modificar ajustes:

- 1 Presione el botón **MENU** en el panel de control para acceder al menú de ajustes en la pantalla del dispositivo.
- 2 Utilice los botones contextuales para ver las distintas opciones.
- 3 Luego de seleccionar un ajuste, presione el botón correspondiente a la opción **Change**.
- 4 Realice las modificaciones pertinentes y seleccione **Set** para confirmar los cambios.

Para cancelar y regresar al menú anterior, presione el botón contextual correspondiente a la opción **Back**. De manera alternativa, oprima **MENU** en el panel de control para retornar a la pantalla de inicio.

Grabación

La opción **Record** permite seleccionar fuentes, determinar la velocidad de transmisión, activar y desactivar el modo de grabación automática o dar formato a las tarjetas de memoria.

Fuentes

La opción **Video Source** permite seleccionar señales SDI o por fibra óptica, en caso de haber instalado el módulo correspondiente.

Modo

Mediante el menú **Mode** se puede seleccionar el modo de grabación.

Duplicate

Esta opción graba el mismo contenido en todas las tarjetas SD simultáneamente.

Single Disk

Esta opción graba en una sola tarjeta SD a la vez y, cuando una se llena, continúa en la siguiente. Cuando a ninguna de las unidades le queda espacio, el dispositivo detendrá la grabación. En caso de contar con múltiples equipos Blackmagic Duplicator 4K conectados en serie, el proceso continuará en el siguiente hasta que se llenen todas las tarjetas SD.

Disk Overwrite

Esta opción brinda la posibilidad de grabar de manera continua, ya que comienza haciéndolo en una tarjeta y, cuando esta se llena, continúa en la siguiente. Cuando a ninguna de las tarjetas le queda espacio, vuelve a la primera unidad SD y continúa con el proceso.

Códec

Utilice esta opción para seleccionar el sistema de compresión deseado.

A continuación se describen ambos códecs:

H.264

Es el sistema de compresión más extendido y ofrece una buena relación entre la calidad de imagen y el tamaño del archivo generado. La mayoría de los sistemas de reproducción fabricados en los últimos diez años permiten reproducir archivos H.264 comprimidos en definición HD, como mínimo.

H.265

Este sistema tiene una capacidad de compresión mayor, por lo que puede reducir a la mitad el tamaño de archivo para una determinada definición. Es excelente para comprimir videos de alta calidad o en definición UHD. Sin embargo, para su reproducción se requerirán dispositivos con tecnología más avanzada.

NOTA: Consulte el apartado *Grabación* en este manual para obtener más información al respecto.

Velocidad de transmisión

La opción **Bit Rate** determina la cantidad de material audiovisual que puede grabarse en las tarjetas de memoria y su calidad. Existen tres opciones disponibles.

High

Seleccione esta opción para obtener la mejor calidad con una compresión mínima.

Medium

Seleccione esta opción para aumentar la capacidad de la tarjeta de memoria sin comprometer la calidad de las imágenes.

Low

Seleccione esta opción para aprovechar al máximo la capacidad de grabación de la tarjeta cuando no es necesario obtener la mejor calidad de imagen posible. Nótese que, en este caso, se emplea un alto grado de compresión, por lo cual podría haber artefactos visibles en el material grabado.

NOTA: El codificador H.265 integrado utiliza tecnología de vanguardia en materia de compresión, a fin de obtener la mejor calidad de imagen con la menor cantidad de datos posible. Aunque se seleccione la opción de menor calidad, la nitidez de la grabación será muy buena.

Velocidades de transmisión para distintos formatos

Ultra HD			
Formato	Opción	Velocidad de transmisión (Mb/s) H.264	Velocidad de transmisión (Mb/s) H.265
2160p60	Alta	75	50
	Media	66	38
	Baja	50	20
2160p59.94	Alta	75	50
	Media	66	38
	Baja	50	20
2160p50	Alta	72	48
	Media	61	32
	Baja	42	16
2160p30	Alta	50	30
	Media	37	20
	Baja	24	10
2160p29.97	Alta	50	30
	Media	37	20
	Baja	24	10
2160p25	Alta	40	25
	Media	32	18
	Baja	20	10
2160p24	Alta	40	25
	Media	32	18
	Baja	20	10
2160p23.98	Alta	40	25
	Media	32	18
	Baja	20	10

HD			
Formato	Opción	Velocidad de transmisión (Mb/s) H.264	Velocidad de transmisión (Mb/s) H.265
1080p60	Alta	40	20
	Media	32	15
	Baja	20	10
1080i60	Alta	40	20
	Media	32	15
	Baja	20	10
1080p59.94	Alta	40	20
	Media	32	15
	Baja	20	10
1080i59.94	Alta	40	20
	Media	32	15
	Baja	20	10
1080p50	Alta	36	20
	Media	28	15
	Baja	18	10
1080i50	Alta	36	20
	Media	28	15
	Baja	18	10
1080p30	Alta	28	15
	Media	20	11
	Baja	11	7
1080p29.97	Alta	28	15
	Media	20	11
	Baja	11	7
1080p25	Alta	24	15
	Media	16	10
	Baja	9	6
1080p24	Alta	24	15
	Media	15	10
	Baja	8	6
1080p23.98	Alta	24	15
	Media	15	10
	Baja	8	6

HD			
Formato	Opción	Velocidad de transmisión (Mb/s) H.264	Velocidad de transmisión (Mb/s) H.265
720p60	Alta	25	12
	Media	17	10
	Baja	9	8
720p59.94	Alta	25	12
	Media	17	10
	Baja	9	8
720p50	Alta	20	12
	Media	14	9
	Baja	7	6

SD			
Formato	Opción	Velocidad de transmisión (Mb/s) H.264	Velocidad de transmisión (Mb/s) H.265
625i50	Alta	18	11
	Media	12	8
	Baja	6	6
525i59.94	Alta	20	12
	Media	14	9
	Baja	7	6

Grabación automática

La opción **Trigger** permite iniciar la copia de contenidos en el dispositivo al presionar el botón de grabación en otros equipos con conexiones SDI.

None

Seleccione esta opción para desactivar esta función.

SDI Start/Stop

Esta opción brinda la posibilidad de comenzar a grabar contenidos en el dispositivo presionando el botón de grabación en otros equipos con conexiones SDI.

Por ejemplo, la cámara Blackmagic URSA Mini siempre transmite una señal de este tipo a través de las salidas SDI, de modo que al empezar el rodaje se dará inicio a la grabación en el dispositivo. En el modelo URSA Mini no es necesario habilitar esta función. Sin embargo, sí se deberá activar en otros equipos compatibles con este modo de grabación.

Timecode Run

Si su equipo no es compatible con la función de grabación automática, es posible configurar el dispositivo Blackmagic Duplicator 4K para que comience a grabar inmediatamente al detectar un código de tiempo activo. Por ejemplo, al habilitar la opción **Record Run** en una cámara y conectar la salida SDI al dispositivo Blackmagic Duplicator 4K, este dará inicio a la copia de contenidos cuando el código de tiempo comience a correr.

Al interrumpir la grabación en la cámara, el código de tiempo se detendrá y en consecuencia también lo hará el dispositivo.

Esta función resulta de suma utilidad. Sin embargo, es preciso comprobar que el equipo esté configurado correctamente antes de proceder con la grabación. Si la opción **time of day** se encuentra seleccionada, la cámara generará un código de tiempo constante que continuará activando el dispositivo, lo cual no es conveniente.

Cómo formatear tarjetas

El dispositivo permite dar formato a 25 tarjetas de memoria simultáneamente.

Para dar formato a las tarjetas de memoria:

- 1 Presione el botón **MENU** en el panel de control para acceder al menú de ajustes.
- 2 Presione el botón contextual correspondiente a la opción **Record** para ver las opciones de grabación.
- 3 Presione los botones junto a las flechas para acceder a la opción **Format Cards** y seleccione **Format**.
- 4 Aparecerá un aviso de advertencia para confirmar el formato. Asimismo, se abrirá otro cuadro de advertencia para informar que este procedimiento no puede revertirse. Antes de continuar, realice un copia de respaldo con toda la información que desea conservar.
- 5 Presione el botón correspondiente a la opción **Format** para confirmar. Presione **Cancel** para regresar a los ajustes de grabación.
- 6 Durante este proceso, las luces situadas encima de cada ranura se encienden de color amarillo. Asimismo, es posible ver una barra de progreso en la pantalla. Al finalizar, los indicadores permanecerán encendidos de color verde y se mostrará un mensaje indicando que las tarjetas están listas para la grabación.
- 7 Presione **OK**. A continuación, presione el botón **MENU** en el panel de control para regresar a la pantalla de inicio.

Ajustes

El menú **Settings** incluye ajustes de red correspondientes a la dirección IP del dispositivo, la máscara de subred, la puerta de enlace y el protocolo DHCP. Al conectar la unidad a una red, es posible controlarla en forma remota mediante software de otras empresas como Telnet.

DHCP ON

Esta opción permite que el dispositivo seleccione automáticamente los ajustes más adecuados. De este modo, el equipo verifica todas las unidades conectadas a la red y establece su dirección IP y otros parámetros a fin de evitar posibles conflictos de configuración. Esta es una manera confiable y sencilla de configurar los ajustes de red con rapidez.

DHCP OFF

Para modificar estos ajustes en forma manual, desactive la opción DHCP y determine la dirección IP, la máscara de subred y la puerta de enlace ingresando los respectivos valores en el menú correspondiente.

Dirección IP, máscara de subred y puerta de enlace

Es posible cambiar estos parámetros en forma manual cuando la opción DHCP no se encuentra activada.

Para editar los campos numéricos:

- 1 Seleccione el campo que desea modificar utilizando los botones correspondientes a las flechas en la pantalla y presione **Change**.
- 2 Utilice los mismos botones para aumentar o disminuir los valores. Manténgalos presionados para cambiar los números con mayor rapidez.
- 3 Seleccione **Set** para confirmar los cambios.

Utilice los botones contextuales para acceder al resto de las opciones y realizar las modificaciones necesarias.

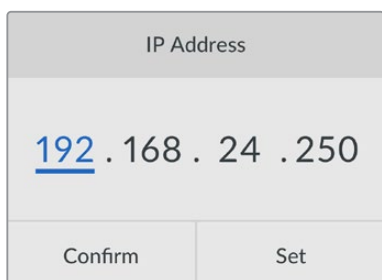

El menú **Settings** permite modificar los ajustes de red a fin de controlar el dispositivo mediante software de otras empresas como Telnet.

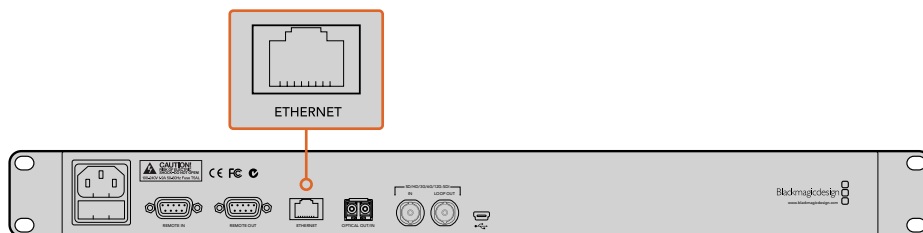

Para conectar la unidad a una red, utilice el puerto Ethernet situado en el panel trasero.

Menú *About*

Este menú proporciona información relativa a la velocidad de transmisión de datos, el nombre del último archivo grabado, el estado de la red y la versión del software interno.

Blackmagic Duplicator Utility

Actualización del dispositivo

El programa Blackmagic Duplicator Utility brinda la posibilidad de actualizar el software interno del dispositivo y modificar el prefijo correspondiente al nombre del archivo para identificar las distintas grabaciones. Se recomienda descargarlo para sacar mayor provecho de las nuevas funciones y mejoras disponibles.

La versión más reciente se encuentra disponible en la página de soporte técnico de Blackmagic Design: www.blackmagicdesign.com/es/support.

Procedimiento de actualización en macOS:

- 1 Descargue y descomprima el archivo **Blackmagic Duplicator Utility**.
- 2 Abra la imagen de disco y ejecute el instalador. Siga las instrucciones que aparecen en pantalla.
- 3 Una vez finalizada la instalación, conecte el dispositivo a su equipo informático mediante un cable USB.
- 4 Ejecute el programa utilitario y haga clic sobre el ícono redondo para acceder a las opciones de configuración. Si se detecta una versión anterior instalada, aparecerá un ícono con el mensaje **Update Now**. Haga clic sobre el mismo para dar inicio a la actualización. Si no es necesario realizar este procedimiento, aparecerá un mensaje indicando que el dispositivo ya cuenta con la versión más reciente del software interno.

Actualización en Windows:

- 1 Descargue y descomprima el archivo **Blackmagic Duplicator Utility**.
- 2 Verá una carpeta denominada **Blackmagic Duplicator Utility** que contiene este manual y el programa de instalación. Haga doble clic en el archivo correspondiente a este programa y siga las instrucciones en pantalla para completar la instalación.
- 3 Una vez finalizada la instalación, conecte el dispositivo a su equipo informático mediante un cable USB.
- 4 Ejecute el programa utilitario y haga clic sobre el ícono redondo para acceder a las opciones de configuración. Si se detecta una versión anterior instalada, aparecerá un ícono con el mensaje **Update Now**. Haga clic sobre el mismo para dar inicio a la actualización. Si no es necesario realizar este procedimiento, aparecerá un mensaje indicando que el dispositivo ya cuenta con la versión más reciente del software interno.

Prefijo del nombre de archivo

El prefijo correspondiente al nombre del archivo puede modificarse para identificar las grabaciones con mayor facilidad. Basta con hacer clic en el campo **File Name Prefix** e ingresar un nombre. El siguiente archivo grabado por el dispositivo tendrá un nombre personalizado seguido de cuatro dígitos que corresponden al número de clip. La numeración incrementa automáticamente al grabar nuevas secuencias.

Para emplear el mismo nombre de archivo en todas las unidades conectadas en serie, presione el botón **REM** en cada una de ellas y luego modifique el prefijo correspondiente en el dispositivo principal. Esto permite utilizar un único nombre para los contenidos grabados en todas las tarjetas.

Instalación de un módulo SDI opcional para fibra óptica

Para transmitir señales SDI mediante una conexión por fibra óptica, es preciso instalar un módulo adicional. El dispositivo es compatible con cualquier módulo SMPTE. Este puede adquirirse en cualquier distribuidor autorizado de productos Blackmagic y se instala en el compartimiento correspondiente situado en el panel trasero de la unidad. El módulo SDI permite utilizar cables de mayor longitud e integrar canales de audio en la señal. Asimismo, esta conexión funciona como una salida derivada adicional.

También es posible instalar módulos de menor velocidad si solo es necesario procesar señales SDI 3G o 6G a fin de reducir costos.

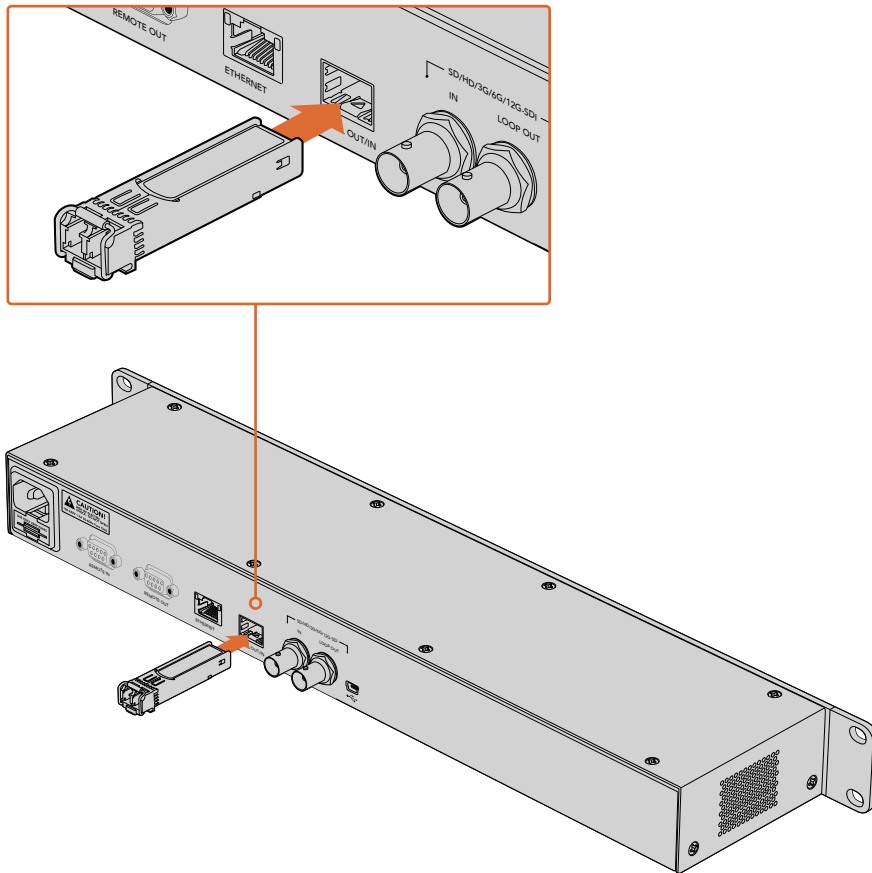

El módulo SDI permite procesar señales por fibra óptica.

En caso de utilizar tanto fuentes SDI como por fibra óptica simultáneamente, el dispositivo procesará aquella que se haya conectado en primer lugar. Sin embargo, es posible alternar entre ambas mediante la opción **Video Source** en el menú que aparece en la pantalla frontal. Consulte el apartado *Ajustes* en este manual para obtener más información al respecto.

Protocolo de control RS-422

¿Qué es el estándar RS-422?

El estándar RS-422 es un protocolo para el control de grabadores profesionales mediante un puerto serial. Ha sido utilizado por una gran cantidad de teledifusoras desde principios de los años 80 y se emplea en varios productos que permiten automatizar la difusión de contenidos. El modelo Blackmagic Duplicator 4K es compatible con dicho protocolo y, por esta razón, puede integrarse a cualquier sistema de automatización y grabación, así como a plataformas de control remoto u otras soluciones diseñadas por el usuario.

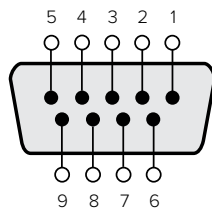

Transmisión (-)	Transmisión (+)	Recepción	Recepción (+)	Descarga a tierra
2	7	8	3	1, 4, 6, 9

Diagrama de pines para el puerto RS-422.

Uso de un controlador RS-422 externo

Este dispositivo incluye un puerto RS-422 compatible con dispositivos Sony® que permite conectar directamente cualquier controlador remoto compatible con dicho estándar.

Es posible utilizar cables de 9 pines prefabricados, siempre que cada una de las conexiones coincida exactamente con la configuración numerada del puerto. Si la configuración de su equipo es distinta y desea armar sus propios cables, consulte el diagrama de la salida remota, a modo de asegurarse de que los pines correspondientes a la transmisión (Tx) estén conectados a los de recepción (Rx).

Al conectar el controlador externo RS-422 al dispositivo, es posible operar la unidad en forma remota.

- 5 Conecte un cable RS-422 del controlador externo a la entrada correspondiente del dispositivo.
- 6 Para habilitar la función de control remoto, presione el botón **REM** situado en el panel de control.

Ahora podrá iniciar o detener la grabación, o anexar clips de manera remota. En el apartado *Comandos compatibles con el estándar RS-422* se proporciona una lista completa de comandos.

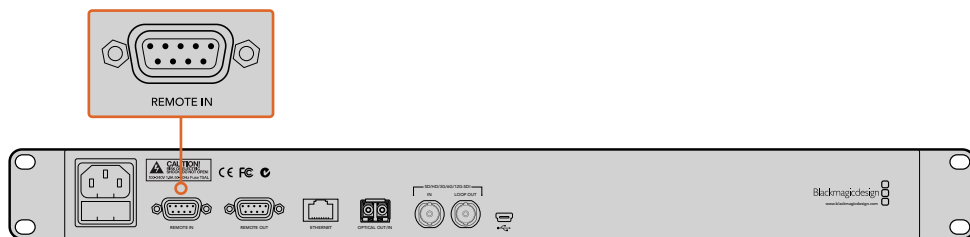

Para controlar la unidad en forma remota, conecte un controlador externo RS-422 a la entrada correspondiente del dispositivo.

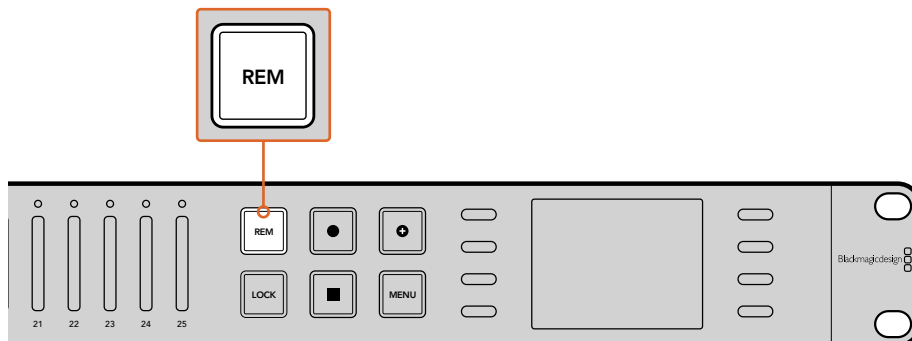

Para habilitar la función de control remoto, presione el botón **REM** situado en el panel de control.

Supported RS-422 Commands

		Command	Reply	No Remote	Notes
0 - System Control					
0x00	0x11	DeviceTypeRequest	NTSC: 0xF0E0 PAL: 0xF1E0 24P: 0xF2E0	Enabled	–

1 - Slave Response					
0x20	0x00	Stop	Acknowledge	Disabled	–
0x20	0x02	Record	Acknowledge	Disabled	–
0x21	0x02	Append	Acknowledge	Disabled	Non-standard command - an extra payload of 0x00 indicates append

4 - Preset/Select Control					
0x40	0x40	AutoMode Off	Acknowledge	Disabled	ignored, Status bit remembered
0x40	0x41	AutoMode On	Acknowledge	Disabled	ignored, Status bit remembered
0x61	0x20	StatusSense	StatusData	Enabled	–

7 - Sense Reply					
0x70	0x20	StatusData	–	–	Please see “Status Bits” sheet: Limited to 9 bytes of status, silently truncated

RS-422 Developer Information

	Bit 7	Bit 6	Bit 5	Bit 4	Bit 3	Bit 2	Bit 1	Bit 0
Byte 0	0	0	Cassette out	0	0	0	0	Local
Byte 1	Standby	0	Stop	0	0	0	Record	0
Byte 2	0	0	0	0	0	0	0	0
Byte 3	Auto Mode	0	0	0	0	0	0	0
Byte 4	Select EE	Full EE	0	0	0	0	0	0
Byte 5	0	0	0	0	0	0	0	0
Byte 6	0	0	0	0	0	0	0	0
Byte 7	0	0	0	0	0	0	0	0
Byte 8	0	0	0	0	0	0	0	0
Byte 9	0	0	0	0	0	0	0	0

Variables	
Cassette Out	Set if no cards are ready to record
Local	Set if in local mode (no remote control)
Standby	Set if one or more cards are ready to record
Auto Mode	For compatibility only
Full EE	For compatibility only - always on
Select EE	For compatibility only - always on

Blackmagic Duplicator 4K RS-422 Settings	
Protocol	Based on Sony 9-pin protocol
Baud Rate	38.4 K
Start Bits	1
Data Bits	8
Stop Bits	1
Parity Bits	1
Parity Type	Odd

Control a distancia mediante redes Ethernet

Es posible controlar el dispositivo externamente a través de una conexión a una red Ethernet, utilizando los comandos de texto del protocolo de Ethernet para el equipo Blackmagic HyperDeck. Esto brinda la capacidad de operar el modelo Duplicator 4K a distancia desde un equipo informático o mediante un programa de control como Telnet, o bien de diseñar un panel de control personalizado y programarlo empleando dicho protocolo.

Asimismo, ofrece al usuario la posibilidad de crear sus propias soluciones para manejar la unidad desde equipos informáticos, dispositivos de control especiales o sistemas profesionales complejos utilizados en estudio o exteriores. Por ejemplo, los microcontroladores Arduino son pequeñas placas de circuitos que pueden personalizarse añadiendo tarjetas de expansión, denominadas *shields*. Existen diversos tipos de tarjetas de expansión con distintos conectores. Para controlar el dispositivo se requiere una tarjeta de expansión de red Ethernet. También pueden adquirirse tarjetas adicionales con botones programables. Los microcontroladores Arduino son accesibles, fáciles de configurar, y su código es abierto. Una vez que se haya programado el software interno de dicho microcontrolador, es posible conectarlo al puerto de Ethernet del dispositivo para controlarlo.

Ejemplo de control mediante microprocesador Arduino

Estos microcontroladores pueden programarse a través de lenguaje de programación C. De este modo, puede utilizarse el protocolo de Ethernet desarrollado para el producto HyperDeck a fin de enviar comandos a la unidad de duplicación. En la sección *Protocolo de Ethernet para el modelo Blackmagic HyperDeck* se incluyen todos los comandos compatibles.

Asimismo, el microprocesador puede combinarse con tarjetas de expansión, con el objetivo de incorporar diversas funciones de grabación. Por ejemplo, si se agrega un reloj interno, es posible programar el controlador para que indique al duplicador que grabe en determinados horarios. Esto puede resultar útil cuando se trabaja con cámaras de seguridad.

Esta tecnología innovadora permite al usuario crear sus propios controladores externos. No dude en compartir sus experiencias con nosotros.



```
BlackmagicDuplicatorControl | Arduino 1.8.5
BlackmagicDuplicatorControl
/*
 * Telnet client Blackmagic Duplicator 4K Control
 *
 * Circuit:
 * Ethernet shield attached to pins 10, 11, 12, 13
 */
#include <SPI.h>
#include <Ethernet.h>

// Enter a MAC address and IP address for your controller below.
// The IP address will be dependent on your local network:
byte mac[] = {0x30, 0xA2, 0x0A, 0x0F, 0x17, 0xEF};
byte ip[] = {192, 168, 28, 204}; //IP address of Ethernet Shield
byte server[] = {192, 168, 28, 85}; //IP address of Duplicator

EthernetClient client; //Give the ethernet client a name

void setup()
{
  Ethernet.begin(mac, ip); //Start the Ethernet connection:
  client.connect(server, 9993); //Connect to Duplicator on port 9993
}

void loop()
{
  while (client.available()) //Read the Duplicator Preamble
  {
    char c = client.read();
  }

  client.print("record: name: CAMEIA1\x0a"); //Start Duplicator recording a clip named Camera 1
  delay(60000); //Wait a minute
  client.print("stop\x0a"); //Stop recoding
  while (1); //Do nothing until program starts again
}

Done Saving
Sketch uses 9,710 bytes (30%) of program storage space. Maximum is 32,756 bytes.
Global variables use 236 bytes (11%) of dynamic memory, leaving 1,812 bytes for local variables. Maximum is 2,048 bytes.
36 Arduino/Genuino Uno on /dev/cu.usbmodem1421
```

Para programar un controlador externo mediante una red Ethernet, al igual que en el ejemplo de la tarjeta de expansión Arduino, basta con utilizar el protocolo de Ethernet que se incluye a continuación, a fin de seleccionar los comandos necesarios para los controles que se requieran.

El código que figura en la imagen anterior también se incluye en la próxima página, por lo que es posible copiarlo y pegarlo en el ambiente de desarrollo integrado (IDE) de la unidad Arduino. En este caso, se programa para instruirle al equipo Blackmagic Duplicator 4K que grabe durante un minuto, luego detenga la grabación y espere hasta que se vuelva a activar una señal.

```

/*
   Telnet client Blackmagic Duplicator 4K Control Circuit: *
Ethernet shield attached to pins 10, 11, 12, 13
*/
#include <SPI.h>
#include <Ethernet.h>

// Enter a MAC address and IP address for your controller below.
// The IP address will be dependent on your local network:
byte mac[] = {0x90, 0xA2, 0xDA, 0x0F, 0x17, 0xEF};
byte ip[] = {192, 168, 28, 204};           // IP address of
Ethernet Shield
byte server[] = {192, 168, 28, 141};      // IP address of Duplicator
EthernetClient client;                   // Give the ethernet
client a name

void setup()
{
  Ethernet.begin(mac, ip);    //Start the Ethernet connection:

  client.connect(server, 9993); //Connect to Duplicator on port 9993
}
void loop()
{
  while (client.available()) //Read the Duplicator Preamble
  {
    char c = client.read();
  }
  client.print("record: name: Camera1\x0a");
  //Start Duplicator recording a clip named Camera 1
  delay(60000); //Wait a minute
  client.print("stop\x0a"); //Stop recoding
  while (1); //Do nothing until program
starts again
}

```

Protocolo de Ethernet para el modelo Blackmagic HyperDeck

Este protocolo de texto fue originalmente diseñado para controlar grabadores HyperDeck mediante un puerto de red Ethernet, aunque también puede utilizarse para controlar el modelo Blackmagic Duplicator 4K.

Debido a que este dispositivo solamente ofrece funciones de grabación, no dispone de todos los comandos que ofrece el protocolo HyperDeck. Esta sección brinda información sobre los comandos relevantes para el duplicador.

Protocol Commands

Command	Command Description
help or ?	Provides help text with all commands and parameters.
remote	Queries the state of HyperDeck's remote control mode.
remote: enable: true	Enables remote control.
remote: enable: false	Disables remote control.
remote: override: true	Turns remote override on.
remote: override: false	Turns remote override off.
quit	Disconnects HyperDeck server.
ping	Determines HyperDeck server is responding.
record	Starts recording.
record: append: true	Starts appended recording.
stop	Stops playback or recording.
commands	Lists all supported commands in an XML format.
notify	Queries the current state of all notifications.
notify: transport: true	Enables transport notifications.
notify: transport: false	Disables transport notifications.
notify: slot: true	Enables slot notifications.
notify: slot: false	Disables slot notifications.
notify: remote: true	Enables remote notifications.
notify: remote: false	Disables remote notifications.
notify: configuration: true	Enables configuration notifications.
notify: configuration: false	Disables configuration notifications.
notify: dropped frames: true	Enables dropped frames notifications.
notify: dropped frames: false	Disables dropped frames notifications.
device info	Provides device information.
slot info: slot id: {slot ID}	Provides information about a specified slot.
transport info	Provides information for the state of the transport.
configuration	Queries the current configuration.
configuration: record mode: Duplicate	Configures the record mode to duplicate.

Command	Command Description
configuration: record mode: SingleDisk	Configures the record mode to single disk.
configuration: record mode: DiskOverwrite	Configures the record mode to disk overwrite.
configuration: video input: {"SDI", "optical"}	Configures video input.
configuration: file format: {format}	Configures the record codec and bit rate.
format: prepare: {format}	prepare a disk formatting operation to filesystem {format}
format: confirm: {token}	perform a pre-prepared formatting operation using token
watchdog: period: {seconds}	Configures the watchdog.

Lenguaje XMLL

Si bien es posible utilizar el terminal para comunicarse con otras unidades HyperDeck, al escribir un programa, puede recurrirse al lenguaje XML para confirmar la existencia de un comando específico, sobre la base del software interno del grabador HyperDeck con el cual se establece una comunicación. Esto ayuda a que la interfaz de usuario se adecue a las capacidades del modelo HyperDeck y la versión del programa que utiliza.

Protocol Details

Connection

The HyperDeck Ethernet server listens on TCP port 9993.

Basic syntax

The HyperDeck protocol is a line oriented text protocol. Lines from the server will be separated by an ASCII CR LF sequence. Messages from the client may be separated by LF or CR LF.

New lines are represented in this document as a "↵" symbol.

Command syntax

Command parameters are usually optional. A command with no parameters is terminated with a new line:

```
{Command name}↵
```

If parameters are specified, the command name is followed by a colon, then pairs of parameter names and values. Each parameter name is terminated with a colon character:

```
{Command name}: {Parameter}: {Value} {Parameter}: {Value} ...↵
```

Response syntax

Simple responses from the server consist of a three digit response code and descriptive text terminated by a new line:

```
{Response code} {Response text}↵
```

If a response carries parameters, the response text is terminated with a colon, and parameter name and value pairs follow on subsequent lines until a blank line is returned:

```
{Response code} {Response text}:↵
{Parameter}: {Value}↵
{Parameter}: {Value}↵
...
↵
```

Successful response codes

A simple acknowledgement of a command is indicated with a response code of 200:

```
200 ok↵
```

Other successful responses carry parameters and are indicated with response codes in the range of 201 to 299.

Failure response codes

Failure responses to commands are indicated with response codes in the range of 100 to 199:

```
100 syntax error
101 unsupported parameter
102 invalid value
103 unsupported
104 disk full
105 no disk
106 disk error
109 out of range
110 no input
111 remote control disabled
120 connection rejected
150 invalid state
```

Asynchronous response codes

The server may return asynchronous messages at any time. These responses are indicated with response codes in the range of 500 to 599:

```
5xx {Response Text}:↵
{Parameter}: {Value}↵
{Parameter}: {Value}↵
↵
```

Connection response

On connection, an asynchronous message will be delivered:

```
500 connection info:↵
protocol version: {Version}↵
model: {Model Name}↵
↵
```

Connection rejection

Only one client may connect to the server at a time. If other clients attempt to connect concurrently, they will receive an error and be disconnected:

```
120 connection rejected↵
```

Timecode syntax

Timecodes are expressed as non-drop-frame timecode in the format:

```
HH:MM:SS:FF
```

Handling of deck "remote" state

The "remote" command may be used to enable or disable the remote control of the deck. Any attempt to change the deck state over ethernet while remote access is disabled will generate an error:

```
111 remote control disabled↵
```

To enable or disable remote control:

```
remote: enable: {"true", "false"} ↵
```

The current remote control state may be overridden allowing remote access over ethernet irrespective of the current remote control state:

```
remote: override: {"true", "false"} ↵
```

The override state is only valid for the currently connected ethernet client and only while the connection remains open.

The "remote" command may be used to query the remote control state of the deck by specifying no parameters:

```
remote↵
```

The deck will return the current remote control state:

```
210 remote info:↵
enabled: {"true", "false"}↵
override: {"true", "false"}↵
↵
```

Asynchronous remote control information change notification is disabled by default and may be configured with the "notify" command. When enabled, changes in remote state will generate a "510 remote info:" asynchronous message with the same parameters as the "210 remote info:" message.

Closing connection

The "quit" command instructs the server to cleanly shut down the connection:

```
quit↵
```

Checking connection status

The "ping" command has no function other than to determine if the server is responding:

```
ping↵
```

Getting help

The "help" or "?" commands return human readable help text describing all available commands and parameters:

```
help↵
```

or:

```
?↵
```

The server will respond with a list of all supported commands:

```
201 help:↵
{Help Text}↵
{Help Text}↵
↵
```

Stopping deck operation

The "stop" command instructs the deck to stop the current capture:

```
stop↵
```

Enumerating supported commands and parameters

The "commands" command returns the supported commands:

```
commands↵
```

The command list is returned in a computer readable XML format:

```
212 commands:
<commands>↵
    <command name="..."><parameter name="...">...</command>↵
    <command name="..."><parameter name="...">...</command>↵
    ...
</commands>↵
↵
```

More XML tokens and parameters may be added in later releases.

Controlling asynchronous notifications

The "notify" command may be used to enable or disable asynchronous notifications from the server. To enable or disable transport notifications:

```
notify: transport: {"true", "false"}↵
```

To enable or disable slot notifications:

```
notify: slot: {"true", "false"}↵
```

To enable or disable remote notifications:

```
notify: remote: {"true", "false"}↵
```

To enable or disable configuration notifications:

```
notify: configuration: {"true", "false"}↵
```

To enable or disable dropped frames notifications:

```
notify: dropped frames: {"true", "false"}↵
```

Multiple parameters may be specified. If no parameters are specified, the server returns the current state of all notifications:

```
209 notify:↵
transport: {"true", "false"}↵
slot: {"true", "false"}↵
remote: {"true", "false"}↵
configuration: {"true", "false"}↵
↵
```

Retrieving device information

The "device info" command returns information about the connected deck device:

```
device info↵
```

The server will respond with:

```
204 device info:↵
protocol version: {Version}↵
model: {Model Name}↵
unique id: {unique alphanumeric identifier}↵
↵
```

Example of response from server:

```
204 device info:↵
protocol version: 1.8↵
model: Blackmagic Duplicator 4K↵
unique id: 101112131415↵
↵
```

Retrieving slot information

The "slot info" command returns information about a slot.

The specified slot will be queried:

```
slot info: slot id: {Slot ID}↵
```

The server will respond with slot specific information:

```
202 slot info:↵
slot id: {Slot ID}↵
status: {"empty", "mounting", "error", "mounted"}↵
volume name: {Volume name}↵
recording time: {recording time available in seconds}↵
video format: {disk's default video format}↵
↵
```

Asynchronous slot information change notification is disabled by default and may be configured with the “notify” command. When enabled, changes in slot state will generate a “502 slot info:” asynchronous message with the same parameters as the “202 slot info:” message.

Retrieving transport information

The “transport info” command returns the state of the transport:

```
transport info ↵
```

The server responds with transport specific information:

```
208 transport info:↵  
status: {"stopped","record"}↵  
display timecode: {timecode}↵  
timecode: {timecode}↵
```

The “timecode” value is the timecode within the current timeline for playback or the clip for record. The “display timecode” is the timecode displayed on the front of the deck. The two timecodes will differ in some deck modes.

Asynchronous transport information change notification is disabled by default and may be configured with the “notify” command. When enabled, changes in transport state will generate a “508 transport info:” asynchronous message with the same parameters as the “208 transport info:” message.

Video Formats

The following video formats are currently supported on Blackmagic Duplicator 4K:

SD

525i59.94 NTSC
625i50 PAL

HD

720p50	1080p30
720p59.94	1080i50
720p60	1080p50
1080p23.98	1080i59.94
1080p24	1080p59.94
1080p25	1080i60
1080p29.97	1080p60

Ultra HD

2160p23.98	2160p30
2160p24	2160p50
2160p25	2160p59.94
2160p29.97	2160p60

Duplicator 4K supports progressive segmented frame modes, and automatically detects level A and level B 3G-SDI formats for 1080p50, 1080p59.94 and 1080p60.

File Formats

Duplicator 4K supports the following file formats:

- H.264Low
- H.264Medium
- H.264High
- H.265Low
- H.265Medium
- H.265High

Querying and updating configuration information

The "configuration" command may be used to query the current configuration of the deck:

```
configuration↵
```

The server returns the configuration of the deck:

```
211 configuration:↵  
video input: {"SDI", "optical"}↵  
↵
```

One or more configuration parameters may be specified to change the configuration of the deck.

To change the current video input:

```
configuration: video input: {"SDI", "optical"}↵
```

Configuring the watchdog

The "watchdog" command instructs the deck to monitor the connected client and terminate the connection if the client is inactive for at least a specified period of time.

To configure the watchdog:

```
watchdog: period: {period in seconds}↵
```

To avoid disconnection, the client must send a command to the server at least every {period} seconds. Note that if the period is set to 0 or less than 0, connection monitoring will be disabled.

Configuring the record mode

Use the 'record mode' command to select the deck recording mode:

```
configuration: record mode: {"Duplicate", "SingleDisk", "DiskOverwrite"}↵
```

Configuring the file format

The 'file format' command instructs the deck to switch to a specific file format for codec and bit rate:

```
configuration: file format: {"H.264High", "H.264Medium", "H.264Low",  
"H.265High", "H.265Medium", "H.265Low"}↵
```

Ayuda

Cómo obtener ayuda

La forma más rápida de obtener ayuda es visitando la página de soporte técnico en nuestro sitio web, donde es posible acceder al material de apoyo más reciente.

Página de soporte técnico de Blackmagic Design

Las versiones más recientes del manual, el software del equipo y el material de apoyo se encuentran disponibles en el centro de soporte técnico de Blackmagic Design: www.blackmagicdesign.com/es/support.

Foro de Blackmagic Design

Este foro permite compartir ideas creativas y constituye un recurso útil para obtener más información sobre nuestros productos. Allí también es posible encontrar rápidamente respuestas de usuarios experimentados o suministradas por el personal de Blackmagic Design. Para acceder al foro, visite la página <http://forum.blackmagicdesign.com>.

Cómo ponerse en contacto con nuestro equipo de soporte técnico

Si no encuentra la ayuda que necesita, solicite asistencia técnica mediante el botón

Enviar correo electrónico situado en la parte inferior de la página de soporte en nuestro sitio web (www.blackmagicdesign.com/es/support). De forma alternativa, haga clic en el botón

Soporte técnico local para acceder al número telefónico del centro de atención más cercano.

Cómo comprobar la versión del software instalada

Para comprobar la versión del programa utilitario instalada en su equipo, seleccione la opción

About Blackmagic Duplicator Utility.

- En macOS, ejecute el programa desde la carpeta de aplicaciones. Seleccione **About Blackmagic Duplicator Utility** en el menú de la aplicación para ver el número de la versión.
- En Windows 8.1, abra el programa mediante el ícono correspondiente en la página de inicio. Haga clic sobre el menú **Help** y seleccione **About Blackmagic Duplicator Utility** para ver el número de versión.
- En Windows 10, abra el programa mediante el ícono correspondiente en el menú **Inicio**. Haga clic sobre el menú **Help** y seleccione **About Blackmagic Duplicator Utility** para ver el número de versión.

Cómo obtener las actualizaciones más recientes

Luego de verificar la versión del programa instalada en el equipo, visite nuestro centro de soporte técnico en www.blackmagicdesign.com/es/support para comprobar si hay actualizaciones disponibles. Aunque generalmente es recomendable ejecutar las últimas actualizaciones, evite realizar modificaciones al sistema operativo interno si se encuentra en medio de un proyecto importante.

Normativas

Tratamiento de residuos de equipos eléctricos y electrónicos en la Unión Europea:



Este símbolo indica que el dispositivo no debe desecharse junto con otros residuos domésticos. A tales efectos, es preciso llevarlo a un centro de recolección para su posterior reciclaje. Esto ayuda a preservar los recursos naturales y garantiza que dicho procedimiento se realice protegiendo la salud y el medioambiente. Para obtener más información al respecto, comuníquese con el distribuidor o el centro de reciclaje más cercano.



Según las pruebas realizadas, este equipo cumple con los límites indicados para dispositivos digitales Clase A, en conformidad con la sección 15 de las normas establecidas por la Comisión Federal de Comunicaciones. Esto permite proporcionar una protección razonable contra interferencias nocivas al operar el dispositivo en un entorno comercial. Este equipo usa, genera y puede irradiar energía de radiofrecuencia, y si no se instala o utiliza de acuerdo con el manual de instrucciones, podría ocasionar interferencias nocivas para las comunicaciones radiales. El funcionamiento de este equipo en una zona residencial podría ocasionar interferencias nocivas, en cuyo caso el usuario deberá solucionar dicho inconveniente por cuenta propia.

El funcionamiento está sujeto a las siguientes dos condiciones:

- 1 Este dispositivo no puede causar interferencias nocivas.
- 2 Este dispositivo debe aceptar cualquier interferencia recibida, incluidas las interferencias que pueden provocar un funcionamiento no deseado.

Declaración ISED (Canadá)

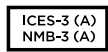

Este dispositivo cumple con las normas del gobierno de Canadá relativas a equipos digitales clase A.

Cualquier modificación o uso indebido del mismo podría acarrear un incumplimiento de dichas normas.

Este equipo cumple con las normas descritas anteriormente al emplearse en entornos comerciales. Nótese que podría ocasionar interferencia radial al utilizarlo en ambientes domésticos.

Seguridad

Para evitar el riesgo de descarga eléctrica, este equipo debe enchufarse a una toma de corriente que disponga de un cable a tierra. Ante cualquier duda, póngase en contacto con un electricista capacitado.

A fin de reducir el riesgo de descarga eléctrica, evite exponer el equipo a goteras o salpicaduras.

Este equipo puede utilizarse en climas tropicales, a una temperatura ambiente máxima de 40 °C.

Compruebe que haya suficiente ventilación en torno a la unidad.

Al instalar el equipo en un bastidor, verifique que el dispositivo contiguo no impida la ventilación.

La reparación de los componentes internos del equipo no debe ser llevada a cabo por el usuario. Comuníquese con nuestro centro de atención más cercano para obtener información al respecto.

Algunos productos pueden conectarse fácilmente a un transceptor óptico SFP. A tales efectos, utilice solamente módulos láser clase 1.

Blackmagic Design recomienda los siguientes modelos:

- **SDI 3G:** PL-4F20-311C
- **SDI 6G:** PL-8F10-311C
- **SDI 12G:** PL-TG10-311C



Evite utilizar el equipo a una altura mayor de 2000 metros.

Declaración del Estado de California

Este producto puede exponer al usuario a compuestos químicos como el cromo hexavalente, que el Estado de California reconoce como posible riesgo de producir cáncer, anomalías congénitas o daños reproductivos.

Consulte el sitio web www.P65Warnings.ca.gov para obtener más información al respecto.

Advertencias para el personal técnico



Precaución: fusible doble (polo activo/neutro)

La fuente de alimentación en este equipo incluye fusibles, tanto en el conductor de línea como en el neutro, y permite su conexión al sistema de distribución eléctrico noruego.

Garantía

12 meses de garantía limitada

Blackmagic Design garantiza que el producto adquirido no presentará defectos en los materiales o en su fabricación por un período de 12 meses a partir de su fecha de compra. Si un producto resulta defectuoso durante el período de validez de la garantía, Blackmagic Design podrá optar por reemplazarlo o repararlo sin cargo alguno por concepto de piezas y/o mano de obra.

Para acceder al servicio proporcionado bajo los términos de esta garantía, el Cliente deberá dar aviso del defecto a Blackmagic Design antes del vencimiento del período de garantía y encargarse de los arreglos necesarios para la prestación del mismo. El Cliente será responsable por el empaque y el envío del producto defectuoso al centro de servicio técnico designado por Blackmagic Design y deberá abonar las tarifas postales por adelantado. El Cliente será responsable de todos los gastos de envío, seguros, aranceles, impuestos y cualquier otro importe que surja con relación a la devolución de productos por cualquier motivo.

Esta garantía carecerá de validez ante defectos o daños causados por un uso indebido o por falta de cuidado y mantenimiento. Blackmagic Design no tendrá obligación de prestar el servicio estipulado en esta garantía para (a) reparar daños provocados por intentos de personal ajeno a Blackmagic Design de instalar, reparar o realizar un mantenimiento del producto; (b) reparar daños resultantes del uso de equipos incompatibles o conexiones a los mismos; (c) reparar cualquier daño o mal funcionamiento provocado por el uso de piezas o repuestos no suministrados por Blackmagic Design; o (d) brindar servicio técnico a un producto que haya sido modificado o integrado con otros productos, cuando dicha modificación o integración tenga como resultado un aumento de la dificultad o el tiempo necesario para reparar el producto. ESTA GARANTÍA OFRECIDA POR BLACKMAGIC DESIGN REEMPLAZA CUALQUIER OTRA GARANTÍA, EXPRESA O IMPLÍCITA. POR MEDIO DE LA PRESENTE, BLACKMAGIC DESIGN Y SUS DISTRIBUIDORES RECHAZAN CUALQUIER GARANTÍA IMPLÍCITA DE COMERCIALIZACIÓN O IDONEIDAD PARA UN PROPÓSITO PARTICULAR. LA RESPONSABILIDAD DE BLACKMAGIC DESIGN EN CUANTO A LA REPARACIÓN O SUSTITUCIÓN DE PRODUCTOS DEFECTUOSOS CONSTITUYE UNA COMPENSACIÓN COMPLETA Y EXCLUSIVA PROPORCIONADA AL CLIENTE POR CUALQUIER DAÑO INDIRECTO, ESPECIAL, FORTUITO O EMERGENTE, AL MARGEN DE QUE BLACKMAGIC DESIGN O SUS DISTRIBUIDORES HAYAN SIDO ADVERTIDOS CON ANTERIORIDAD SOBRE LA POSIBILIDAD DE TALES DAÑOS. BLACKMAGIC DESIGN NO SE HACE RESPONSABLE POR EL USO ILEGAL DE EQUIPOS POR PARTE DEL CLIENTE. BLACKMAGIC DESIGN NO SE HACE RESPONSABLE POR DAÑOS CAUSADOS POR EL USO DE ESTE PRODUCTO. EL USUARIO UTILIZA EL PRODUCTO BAJO SU PROPIA RESPONSABILIDAD.

© Copyright 2019 Blackmagic Design. Todos los derechos reservados. *Blackmagic Design, DeckLink, HDLink, Videohub Workgroup, Videohub, DeckLink, Intensity* y *Leading the creative video revolution* son marcas registradas en Estados Unidos y otros países. Todos los demás nombres de compañías y productos pueden ser marcas comerciales de las respectivas empresas a las que estén asociadas. El nombre Thunderbolt y el logotipo respectivo son marcas comerciales de Intel Corporation en Estados Unidos y otros países.

Blackmagicdesign



安装操作手册

Blackmagic Duplicator 4K

2019年2月

中文



欢迎辞

感谢您购买Blackmagic Duplicator 4K!

Blackmagic Duplicator 4K是一款让人无比激动的产品。有了它，您就能向客户直接交付高品质Ultra HD内容，无愧为一套完美的解决方案。由于这款复制机可以凭借其广泛使用的H.264或最新的H.265压缩处理技术，在多达25张SD卡上记录包括SD、HD和Ultra HD在内最高可达2160p60的所有视频格式，为您提供绝佳品质高帧率影像记录的同时还能保证低数据速率，从而在低成本存储卡上进行长时间记录。

Blackmagic Duplicator 4K安装快捷且使用简单。它的前面板内置LCD屏幕和控制面板，可用来更改各项设置并使用按钮控制设备。此外，您也能通过以太网或连接RS-422控制器实现复制机的远程控制。您还可以使用Blackmagic HyperDeck Ethernet Protocol以太网协议来定制属于自己的控制器来控制设备。

这款复制机搭载实时H.265视频编码器，能在低成本SD卡上记录高品质影像，并且视频格式最高可达Ultra HD 2160p60，因此无需使用高速存储卡也能记录精彩绝伦的Ultra HD影像。在最新的Blackmagic Duplicator 4K 1.2版软件中，我们添加了H.264压缩，因此还可录制H.264文件，从而实现更高的兼容性!

Blackmagic Duplicator 4K机身高度仅占一个机架单位，因此您可以将多台复制机以菊链式连接到一起，安装在移动式机架系统中作为便携式现场设备使用，实现同时在数百张SD卡上进行记录。

本操作手册包含使用Blackmagic Duplicator 4K所需之全部信息。

请登陆公司网站www.blackmagicdesign.com/cn并进入支持页面获得Blackmagic Duplicator 4K的最新版操作手册及其软件更新。请注意定期更新您的软件以便获得最新功能! 下载软件时，请注册您的相关信息，以便我们发布新软件时能及时通知您。我们将不断致力于产品的功能开发和改进，并热忱期待您的意见和建议!

A stylized, handwritten signature in black ink that reads "Grant Petty".

Grant Petty

Blackmagic Design首席执行官

目录

Blackmagic Duplicator 4K

入门	191
连接电源	191
连接视频和音频	191
菊链式连接	192
插入及格式化SD卡	193
记录	194
设置记录模式	194
设置编解码器	195
设置比特率	196
记录片段	197
LED状态提示灯	197
合并记录	198
锁定Blackmagic Duplicator 4K	199
菊链式连接多台复制机	199
LCD菜单设置	201
记录	201
设置	206
关于	207
Blackmagic Duplicator Utility	207
更新Blackmagic Duplicator 4K	207
文件名前缀	207
安装选购的Optical Fiber SDI Module	208
RS-422控制	209
什么是RS-422控制?	209
使用外部RS-422控制器	209
RS-422 Developer Information	211
通过以太网远程控制	211
Arduino控制示例	212
Blackmagic HyperDeck以太网协议	214
Protocol Commands	214
Protocol Details	215
Configuring the watchdog	220
Configuring the record mode	220
Configuring the file format	220
帮助	221
监管告知	222
安全信息	223
保修	224

入门

Blackmagic Duplicator 4K使用前的准备工作非常简单!

只需通过简单步骤连接电源和SDI视频源, 并插入25张SD卡便可开始工作。如果您想要在更多张SD卡上进行记录, 还可以将多台Blackmagic Duplicator 4K以菊链式连接在一起。连接方法非常简单, 因为设备自带用于连接到下游设备的视频和控制接口。本操作手册将在这一章节为您详细介绍如何准备和调试您的Blackmagic Duplicator 4K, 以便您立即开始在多张SD卡上同时进行记录。

连接电源

为Blackmagic Duplicator 4K连接电源时, 只需将标准IEC电源线插入设备后面板的110–240V AC电源输入接口即可。

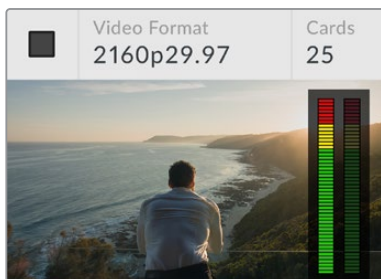

完成电源连接后, Blackmagic Duplicator 4K的内置LCD屏幕将显示主页面。

主页面

主页面可显示源视频画面和源视频格式及插入SD卡数量等相关信息; 并设有状态提示灯, 可在您记录和停止记录时予以提示; 此外, 设备还提供音频表, 便于监看源视频的音频电平指标。

连接视频和音频

将源视频连接到设备后面板的12G-SDI输入接口。Blackmagic Duplicator 4K将自动检测输入格式, 并将其显示在LCD主页面上。

设备的SDI输入和输出BNC接口支持高达12G-SDI的视频信号, 因此您可通过单根BNC线缆连接SD、HD或Ultra HD最高可达2160p60的视频。这样一来, 设备的环通输出接口将始终匹配您的源视频格式, 以便您将同样的信号输出到其他SDI视频设备上, 也可将它用于菊链式连接多台Blackmagic Duplicator 4K。它还支持逐行分段传输模式, 自动检测A级和B级1080p50、1080p59.94和1080p60的3G-SDI格式。

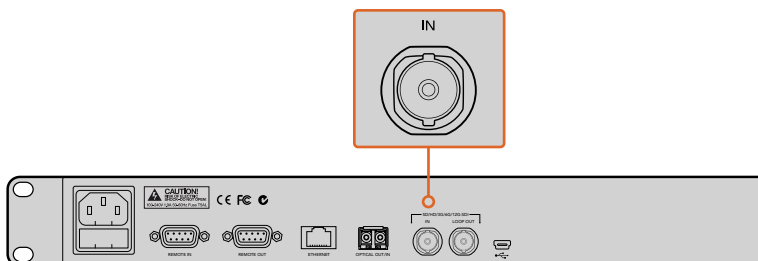

将源视频连接到SDI IN输入接口。音频可嵌入到SDI视频信号上。

Blackmagic Duplicator 4K支持2通道嵌入SDI音频, 因此您无需连接音频, 因为它已经通过SDI视频输入接口完成连接。

提示 您可以在LCD主页面上监测视频源的音频电平。

菊链式连接

您可以将多台Blackmagic Duplicator 4K以菊链式连接到一起, 从而实现在更多张SD卡上进行记录。举例说明, 如果您想要将内容复制到100张卡上, 只需以菊链式连接4台设备即可。

- 1 将第一台Blackmagic Duplicator 4K的RS-422远程输出接口连接至第二台Blackmagic Duplicator 4K的远程输入接口上。重复上述操作, 依次完成其余设备连接。
- 2 同样的, 将第一台设备的SDI环通输出接口连接到第二台设备的SDI输入接口上, 并重复上述操作来依次连接每台下游设备。
- 3 每台设备的控制面板上都有一个标有“REM”的按钮, 即遥控按钮, 请开启该按钮来启用设备之间的远程控制。从菊链中的第二台Blackmagic Duplicator 4K开始, 依次按下每台Blackmagic Duplicator 4K上的遥控按钮。

备注 请确保首台设备的远程按钮设为关闭, 因为这台Blackmagic Duplicator 4K将控制菊链中所有其他设备。远程功能关闭的这部首台设备是主设备, 在该设备前面板上按下的任何按钮将从远程输出上输出, 从而控制那些打开了远程按钮的下游设备。任何具有RS-422录机控制的电视产品都可作为主设备, 因为该远程协议就是工业标准的录机控制格式。

完成连接后, 菊链中的所有Blackmagic Duplicator 4K应都可服从第一台设备发出的命令了。

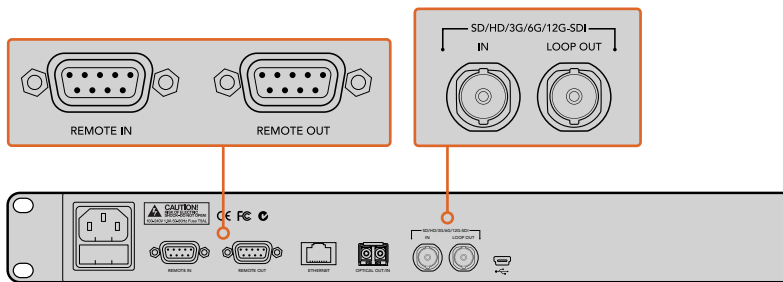

“REMOTE”和“LOOP”接口可被用于以菊花链式连接多台Blackmagic Duplicator 4K。菊花链中最后一台设备上的LOOP接口还能用于将源视频环通输出到Blackmagic SmartView监视器或HyperDeck硬盘录机等其他SDI设备上。

有关菊花链式连接多台设备的详细信息, 请参考名为“菊花链式连接多台复制机”的章节。

插入及格式化SD卡

Blackmagic Duplicator 4K使用常见的10级SD卡, 因此您并不一定要购买市面上读取速度最快的存储卡。您可到任何出售摄影机设备的器材店购买SD卡, 甚至有些超市也销售10级SD卡。

提示 所有SD卡标签上都标有一个印有1到10的数字的小圆圈。这个数字代表了卡的速度等级, 10是最快的等级。任何圆圈内印有数字10的存储卡就是10级SD卡, 这类存储卡可以在最高的比特率设置下记录高达Ultra HD视频。

插入SD卡步骤如下:

- 1 手持存储卡, 将卡的金色接触点面向控制面板的LCD屏幕, 并对准Blackmagic Duplicator 4K的SD卡槽。
- 2 将存储卡轻轻推入卡槽, 直至固定到位。Blackmagic Duplicator 4K验证存储卡时处理速度快, 存储卡就绪后卡槽上方相应的LED状态灯会变成绿色。

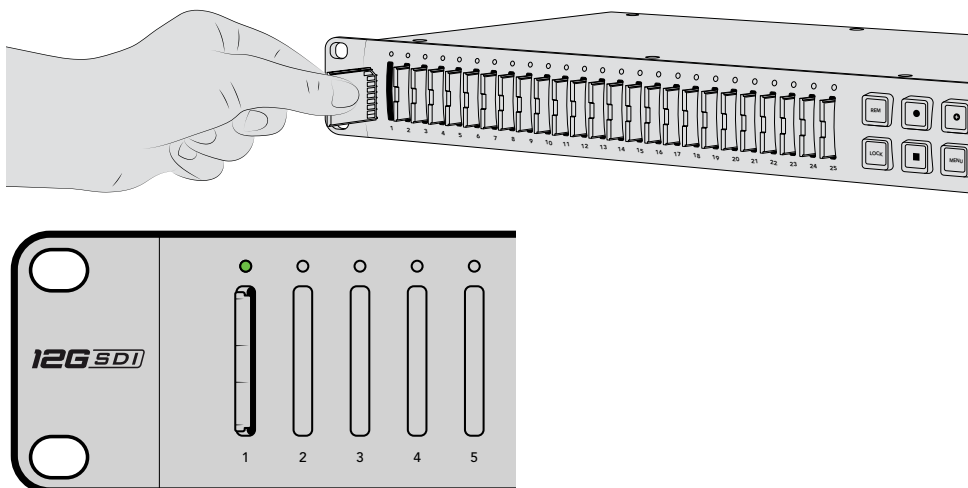

将SD卡的金色接触点朝向LCD屏幕, 轻轻将其推入卡槽, 直至其固定到位。存储卡准备就绪可记录时, LED状态灯会变成绿色。

要移除存储卡, 只需握住其边缘并将其从卡槽中取出即可。

提示 插入存储卡之前, 请先确保该卡没有设写保护。找到位于SD卡左侧的塑料开关, 将该塑料开关移动到最靠近接触点的位置即可禁用写保护功能。记录完毕后, 您可以将此开关移动回底部位置, 从而开启SD卡的写保护功能。

格式化SD卡

开始记录前, 请先将您的SD卡格式化为exFAT格式。该格式可同时兼容macOS和Windows计算机。使用Blackmagic Duplicator 4K的“Format” (格式化) 功能就能快速格式化存储卡, 并且一台设备上可以同时多达25张SD卡进行格式化。

在Blackmagic Duplicator 4K上格式化SD卡步骤如下:

- 1 按控制面板上的“MENU” (菜单) 按钮。
- 2 使用位于LCD屏幕一侧亮起的菜单软按钮, 并按下“Record” (记录)。
- 3 按下向左箭头软按钮来选择“Format Cards” (格式化存储卡) 设置, 然后按下LCD菜单右下角的“Format” (格式化)。
- 4 屏幕会弹出提示信息要求您确认格式化。按“Format” (格式化) 软按钮确认, 或按“Cancel”停止操作。
- 5 进度栏将显示格式化的进程。格式化完成后, 按“OK”。
- 6 按控制面板上的“MENU” (菜单) 按钮可返回主页面。

按控制面板上的“MENU” (菜单) 按钮可返回主页面。

一切准备就绪。只要连接了视频和音频, 并格式化SD卡后, 您就可以开始记录了!

提示 不同类型和大小的SD卡可能会以不同的速度格式化, 因此有些卡会比其他卡更快完成格式化。

记录

按控制面板上的记录按钮可立即开始记录。但我们建议先设置记录模式、编解码和比特率, 因为它们决定了所使用的记录类型, 以及记录的长度和品质。

设置记录模式

Blackmagic Duplicator 4K设有以下几种记录模式:

- **Duplicate (复制)**: 同时写入所有SD卡。
- **Single Disk (单卡)**: 按顺序一次写入一张SD卡, 当最后一张卡存满后停止记录。
- **Single Disk Overwrite (单卡覆盖)**: 按顺序一次写入一张SD卡, 当最后一张卡存满后回到第一张卡上开始覆盖内容循环记录。

Duplicate (复制模式)

在复制模式下, Blackmagic Duplicator 4K会同时将相同的视频记录到所有的SD卡上。

Single Disk (单卡模式)

Blackmagic Duplicator 4K是适用于电视广播机构到监控摄像头等大多数场合的理想录机。它可以一次记录到一张SD卡中, 当SD卡存满后, 还可以继续记录到下一个可用的SD卡中。当Blackmagic Duplicator 4K位于单卡模式时, 所有SD卡都存满后将停止记录。录机设有25个可记录卡槽, 记录时间长达一周。您可以在任何时候将存满的卡更换成空卡继续不间断记录。

如果您采用多台录机菊链式连接, 甚至可实现更长时间记录。一旦主设备的所有卡存满后, 菊链中的第一台从属设备会开始继续记录, 以此类推。当最后一台设备的最后一张卡存满后则停止记录。

Single Disk Overwrite (单卡覆盖模式)

当Blackmagic Duplicator 4K装有两张或更多SD卡并且在单卡覆盖模式下时, 最后一张卡存满后, 设备会回到第一张卡上继续循环记录, 周而复始。一次可写入一张SD卡。当一张SD卡存满后, 设备会格式化下一张可用的卡并开始写入。

这一模式和单卡模式类似, 只是在单卡覆盖模式下时, 设备格式化和写入下一张卡是循环进行的, 而不是像单卡模式那样在最后一张卡存满后就停止记录。在单卡覆盖模式下, Blackmagic Duplicator 4K将周而复始继续记录下去, 直到您按下停止按钮。

提示 如果以单卡模式或单卡覆盖模式记录, 任意时候都可以插入一张具有存储空间的新SD卡。只要25个卡槽中任何一个卡槽有空间, Duplicator 4K就会继续记录。

要设置记录模式步骤如下:

- 1 启动Blackmagic Duplicator 4K。
- 2 按下前控制面板上的“MENU” (菜单) 按钮, 打开LCD菜单。屏幕旁边亮起的多功能按钮显示了菜单上的选项。按下RECORD (记录) 多功能按钮。
记录菜单在屏幕下方设有小点, 提示了可用的选项。如果您想要任何时候移动到上一级菜单, 可按下BACK (后退) 按钮。使用“<”和“>”按钮可在选项间循环。
- 3 导航至“MODE” (模式) 选项, 点击“CHANGE” (更改)。
- 4 按“SELECT”按钮可使用当前显示的模式。LCD菜单提示了您所选中的选项。
- 5 按“BACK” (后退) 按钮可回到记录菜单。设备会显示您所选中的选项。

更多关于菊链式连接多台录机的详细信息, 请查阅“菊链式连接”和“菊链式连接多台复制机”部分的介绍。

提示 如果以单卡或单卡覆盖模式记录重要事件, 不想等待当前存储卡存满就移除SD卡时, 只要长按“RECORD”按钮三秒即可切换到下一张SD卡进行记录。当以复制模式记录时, 只要按下标有加号的合并记录按钮即可。更多相关信息, 请查阅“合并记录”部分的介绍。

设置编解码器

Blackmagic Duplicator 4K可以使用H.264或H.265压缩编解码器记录文件。默认情况下, Duplicator 4K使用H.264压缩。

更改比特率设置步骤如下:

- 1 按“MENU” (菜单) 按钮。
- 2 按下“Record” (记录) 多功能按钮来打开记录设置。
- 3 使用箭头多功能按钮进行导航并找到“Codec” (编解码器) 设置, 然后按“Change” (更改)。
- 4 使用箭头多功能按钮来选择相应的编解码器, 然后按“Set” (设置) 确认更改, 或按控制面板上的“MENU” (菜单) 按钮确认更改并回到LCD主页面。

备注 您的Blackmagic Duplicator 4K软件必须更新至1.1或更高版本才能更改编解码器。有关软件更新的更多信息, 请参阅本手册中“Blackmagic Duplicator Utility”部分的内容。

选择正确的编解码器

为了达到最佳的兼容性, 建议使用H.264编解码器。这正是我们把H.264设置成Blackmagic Duplicator 4K默认的编解码器的原因。

H.265是一款极佳的编解码器, 特别适用于小容量文件的高质量Ultra HD视频, 但它仍然还很新, 因此与计算以及播放设备的兼容性稍微逊色了点。

两种编解码器各具优点。使用H.265可以节省SD卡的存储空间, 因为比特率和文件大小都低于给定的画质。如果兼容性对于您的项目至关重要, 那么H.264是一个很好的选择。

设置比特率

Blackmagic Duplicator 4K共有三种比特率设置, 分别为“Low” (低)、“Medium” (中) 和“High” (高)。您可以通过这三个选项来选择设备内置的H.265编码器每秒为视频写入多少数据。默认的比特率设置为“Medium” (中), 以便获得高品质记录和便于管理的文件大小。但您也可以通过LCD屏幕菜单来快速更改这一设置。

更改比特率设置步骤如下:

- 1 按“MENU” (菜单) 按钮。
- 2 按下“Record” (记录) 软按钮来打开记录设置。
- 3 使用箭头软按钮进行导航并找到“Bit Rate” (比特率) 设置, 然后按“Change” (更改)。
- 4 使用箭头软按钮来选择相应的比特率, 然后按“Set” (设置) 确认更改, 或按控制面板上的“MENU” (菜单) 按钮确认更改并回到LCD主页面。

备注 高比特率将以更高的品质来记录, 但会更早录满存储卡或者需要更大且更贵的存储卡。虽然降低码流可增加您在存储卡上的记录时间, 但记录获得的图像品质就会低于您的预期。

建议您最好使用不同的比特率设置记录进行不同的尝试, 以便以最小的文件尺寸获得您所要求的画质。

记录片段

按控制面板上的记录按钮即可开始记录。记录时，每个卡槽对应的LED状态提示灯将亮起红色。停止记录时，LED提示灯将亮起绿色，表示已记录成功，并且SD卡已准备好记录下一个片段。您可以通过计算机的SD卡槽或读卡器来快速检查记录情况，或者也可使用支持SD卡和exFAT文件系统的HDMI电视机进行查看。

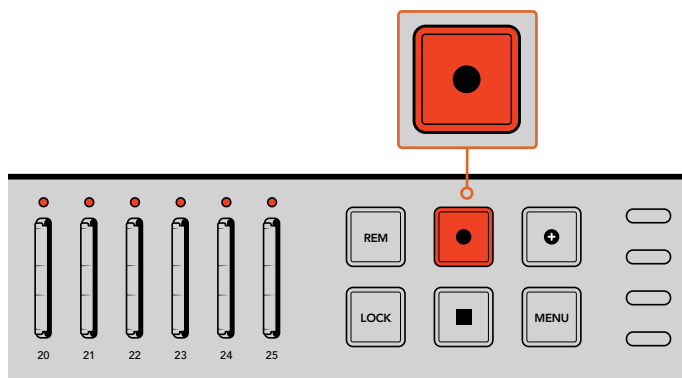





按记录按钮即可开始影像记录。每个SD卡槽上方相对应的LED状态灯会亮起红色来表示该SD卡槽正处于记录状态。

LED状态提示灯

每个SD卡槽上方相对应的LED状态灯能亮起不同的颜色来表示该卡槽的状态。例如，插入SD卡时，如果设备成功将其识别并准备就绪可以开始记录时，卡槽上方对应的LED将亮起绿色。

一下内容为您详细介绍了每种LED色彩、LED闪烁方式及其相应代表的状态：

-  **持续亮起绿色**
准备记录。SD卡就绪时LED将亮起绿色。
-  **持续亮起红色**
正在记录。记录片段时LED将持续显示红色。
-  **闪烁红色**
正在记录，且存储卡几乎存满。提示灯闪烁则代表存储卡上的剩余记录时间不足3分钟。
-  **快速闪烁红色**
丢帧。SD卡写入速度跟不上存储速度。
-  **持续亮起黄色**
存储卡已满、写保护或写入失败。如果记录期间LED持续亮起黄色，则表示您的SD卡可能出现问题、启用写保护、尚未格式化，或者存储空间不足十秒。尝试将Lock按键切换至非锁定状态、降低数据速率、使用更快的SD卡、将其格式化或更换一张存储卡等。

虽然设备会为每张卡上的文件系统保持有序管理,并随时准备应对记录时存储卡被移除的情况,但还是请您务必不要在Blackmagic Duplicator 4K记录时移除SD卡。这是因为有些可以用来查看存储卡的操作系统并没有其他操作系统稳定,因此上述行为可能会被这些操作系统认定为记录损坏。因此,请务必先停止记录,再移除存储卡。如果您想要在表演结束前就将存储卡拿给他人查阅,建议您使用多台复制机,因为这样一来您就可以提早停止其中一台的记录工作,将该设备中的存储卡发放给大家,而此时另一台设备可仍然处于继续记录状态。

提示 10级速度等级的SD卡可记录Blackmagic Duplicator 4K所支持的所有码流,如果需要的话您也可以使用较低等级的存储卡记录较低的码流。例如,您可能想要记录时长较长的安全版本,但不需要最高的视频质量。我们建议您进行测试记录从而确保您的SD卡可以您选定的比特率来记录视频。关于SD卡速度等级的更多信息,请参阅入门章节的“插入及格式化SD卡”部分。

合并记录

在复制模式记录时,您可能想要将新片段继续连着记录到之前记录的片段上,使两个片段成为一个片段。例如,您可能需要记录一场含有多个活动的演出活动。如果您想要把每个活动内容单独记录下来,然后把它们合成一个完整片段,就可以使用设备的“合并记录”功能。

- 1 首先,请使用记录按钮,按照正常操作方式记录第一个片段。然后按停止按钮。
- 2 当下一个活动时,按标有加号的合并记录按钮。该按钮将与记录按钮一同亮起,提示您此时正在记录的片段将会被拼接到之前记录的片段后。
- 3 然后按停止按钮。新片段就会被合并到之前记录的第一个片段后面,并且作为单个片段保存。

提示 使用“Append Record”合并记录功能并不限制您想要合并到第一个片段后的片段数量。唯一的考量就是存储卡的容量和记录的时长。

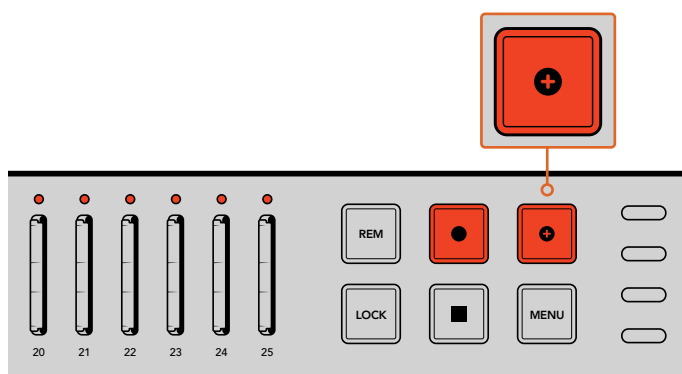

按合并记录按钮可将新片段拼接到之前记录的片段后。

提示 当以单卡或单卡覆盖模式记录时，您可以长按“RECORD”三秒移至下一张存储卡，为当前存储卡节省空间。如果您在重要事件后立即想要查看却不想停止记录时，这个方法非常实用。更多关于单卡或单卡覆盖模式记录的内容，请查阅“设置记录模式”部分的介绍。当以复制模式记录时，只要按下标有加号的合并记录按钮即可。更多相关信息，请查阅“合并记录”部分的介绍。

锁定Blackmagic Duplicator 4K

记录重要活动时，您需要锁定控制面板，防止记录意外终止。此外，对菊链中的从属设备进行锁定也能有效防止任何设备意外干扰记录工作。

使用“LOCK”按钮可单独启用或禁用每台设备的锁定功能。意外解锁设备的情况非常少见，因为您需要按住每台设备上的“LOCK”按钮两秒以上方可执行解锁控制。

锁定Blackmagic Duplicator 4K步骤如下：

- 1 按下Blackmagic Duplicator 4K前面板上的“LOCK”按钮。
- 2 要解锁该设备，请长按“LOCK”按钮。2秒过后，设备将被解锁。

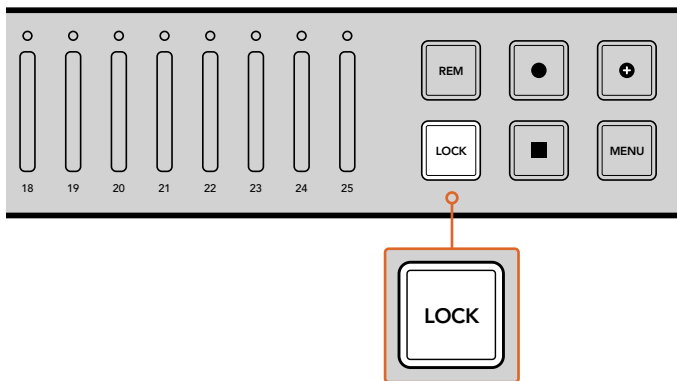

锁定Blackmagic Duplicator 4K的控制面板可有效防止意外终止记录的现象发生。

菊链式连接多台复制机

如果您需要在多于25张SD卡上进行记录，可将多台Blackmagic Duplicator 4K以菊链式连接到一起。完成菊链式连接后，设备将通过每台设备上的“LOOP”环通SDI接口共享同一个视频信号，并且可通过它们的“REMOTE”接口使用RS-422协议实现相互通信。

菊链式连接多台Blackmagic Duplicator 4K步骤如下:

- 1 使用常见的带有DB-9接口的串行电缆将第一台设备的RS-422“REMOTE OUT”端口和第二台设备的“REMOTE IN”端口相连接。您可从当地计算机或影像器材店购买带有DB-9接口的串行电缆。
- 2 将第一台设备的“LOOP”SDI输出连接第二台设备的SDI输入。

就是这么简单! 要对更多台Blackmagic Duplicator 4K进行菊链式连接, 只需继续将每台设备的“REMOTE”和“LOOP”输出接口和下一台设备的远程和SDI输入接口依次连接完毕即可。

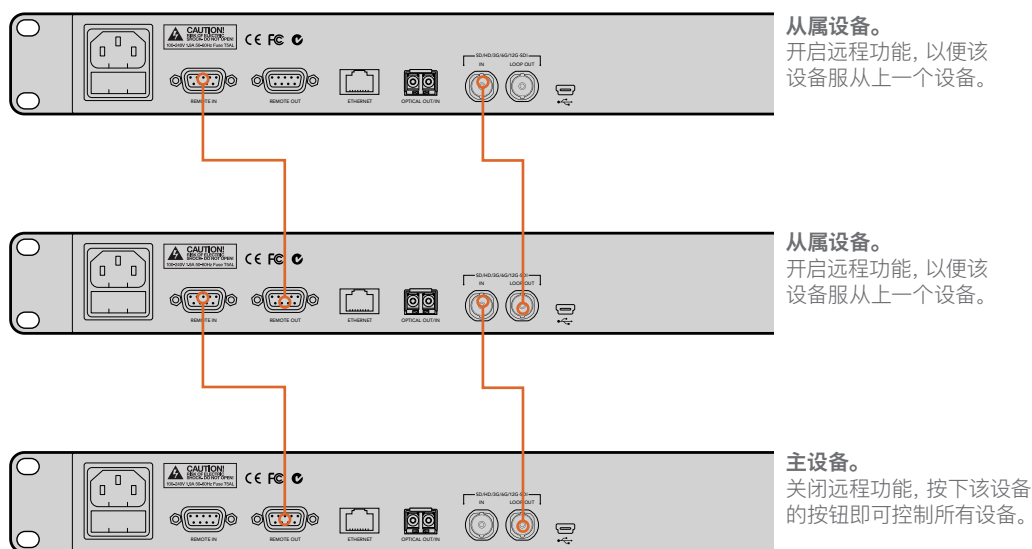

要将多台Blackmagic Duplicator 4K以菊链式连接到一起, 只需将一台设备的环通输出接口连接下一台设备的SDI输入接口即可。以此类推, 将一台设备的远程输出接口连接下一台设备的远程输入接口。

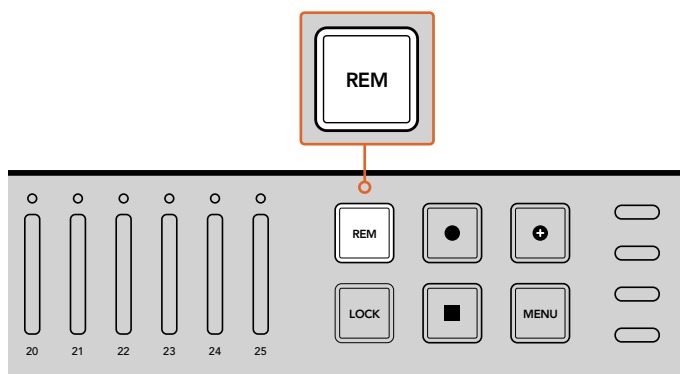

按下菊链中每台从属设备上的“REM”远程按钮, 以便主设备通过远程控制的方式对它们进行控制。

备注 请确保您按下每台从属设备控制面板上的“REM”（远程）按钮以启用远程控制。启用后，“REM”按钮将亮起。再次按下该按钮可禁用该功能。

开始最后记录前, 请先进行一次测试记录, 以确保所有设备均受主设备控制。如果从属设备不服从主设备控制, 请检查主设备的远程按钮是否关闭, 并且检查从属设备的远程按钮是否开启。

LCD菜单设置

Blackmagic Duplicator 4K所有设置都可以通过控制面板上的LCD菜单和软按钮进行更改。软按钮位于LCD屏幕的两侧，并将对应于LCD菜单上的设置显示而亮起。

更改设置步骤如下：

- 1 按下控制面板上的“MENU”（菜单）按钮，打开LCD菜单设置。
- 2 使用菜单软按钮进行菜单导航。
- 3 一旦选定了设置，请按“Change”（更改）菜单软按钮。
- 4 调整设置，然后按“Set”（设置）以确认更改。

如果要取消更改，只需按下“Back”（退回）菜单软按钮就可以逐层返回上一级菜单；或者只需按下控制面板上的“MENU”（菜单）按钮，使LCD屏幕退回到主页面。

记录

“Record”（记录）设置可以让您更改视频源，设置比特率、启用或禁用触发记录功能，以及格式化您的SD卡。

视频源

如果您安装有光纤SDI模块，此设置可用来在SDI输入和光纤输入间进行选择。

模式

使用这一设置可选择一个记录模式：

Duplicate (复制)

同时将同个视频记录到所有SD卡上。

Single Disk (单卡)

一次记录到一张SD卡中，当SD卡存满后，将继续记录到下一个可用的SD卡中。当所有卡存满后，Duplicator 4K停止记录。如果您将多台设备菊链式连接在一起，那么设备会在下一台Duplicator 4K上继续记录，直到所有SD卡存满为止。

Single Disk Overwrite (单卡覆盖)

循环继续记录。一次记录到一张SD卡中，当SD卡存满后，将继续记录到下一个可用的SD卡中。当所有卡存满后，Duplicator 4K将回到第一张SD卡继续记录。

编解码

使用这一设置，将Blackmagic Duplicator 4K设置成使用H.264和H.265压缩编解码器进行录制。

下面是这两种不同的编解码器的详细说明。

H.264

十分常用的压缩格式，较好地平衡了画质和文件大小。过去十年生产的大部分播放设备都能播放采用这类编解码器压缩的文件，最高至少可达HD分辨率。

H.265

非常高效的压缩格式，与H.264相比，该格式能获得画质相同但大小减半的视频文件。此编解码器非常适用于高质量或Ultra HD视频的封装，但是可能需要更新版本的回放软件和硬件才能观看。

备注 有关H.264和H.265区别的详细信息，请参阅本手册的“记录”部分。

比特率

比特率设置决定了可以在您SD卡上记录的视频大小以及视频录制的质量。此处有三个选项供您选择。

High (高)

当您想要最低压缩的最高质量视频时，请选择“High”（高）。

Medium (中)

如果您想要在SD卡上记录更多视频但又想要相对较好的画质时，请选择“Medium”（中）。

Low (低)

如果您想要在SD卡上记录最多的视频，且不需要最高的视频质量时，请选择“Low”（低）。此设置将使用最大压缩，因此您可能会看到记录中明显的压缩失真现象。

备注 内置H.265编码器使用的是最新压缩技术，您可以使用最少的数据获得高质量视频记录。即使是设置为最低质量，使用了最大的视频压缩，您的记录质量仍将很好。

视频格式的比特率

Ultra HD			
视频格式	比特率设置	比特率 (Mb/s) H.264	比特率 (Mb/s)H.265
2160p60	高	75	50
	中	66	38
	低	50	20
2160p59.94	高	75	50
	中	66	38
	低	50	20

Ultra HD			
视频格式	比特率设置	比特率 (Mb/s) H.264	比特率 (Mb/s)H.265
2160p50	高	72	48
	中	61	32
	低	42	16
2160p30	高	50	30
	中	37	20
	低	24	10
2160p29.97	高	50	30
	中	37	20
	低	24	10
2160p25	高	40	25
	中	32	18
	低	20	10
2160p24	高	40	25
	中	32	18
	低	20	10
2160p23.98	高	40	25
	中	32	18
	低	20	10

HD			
视频格式	比特率设置	比特率 (Mb/s) H.264	比特率 (Mb/s)H.265
1080p60	高	40	20
	中	32	15
	低	20	10
1080i60	高	40	20
	中	32	15
	低	20	10
1080p59.94	高	40	20
	中	32	15
	低	20	10
1080i59.94	高	40	20
	中	32	15
	低	20	10
1080p50	高	36	20
	中	28	15
	低	18	10

HD			
视频格式	比特率设置	比特率 (Mb/s) H.264	比特率 (Mb/s)H.265
1080i50	高	36	20
	中	28	15
	低	18	10
1080p30	高	28	15
	中	20	11
	低	11	7
1080p29.97	高	28	15
	中	20	11
	低	11	7
1080p25	高	24	15
	中	16	10
	低	9	6
1080p24	高	24	15
	中	15	10
	低	8	6
1080p23.98	高	24	15
	中	15	10
	低	8	6
720p60	高	25	12
	中	17	10
	低	9	8
720p59.94	高	25	12
	中	17	10
	低	9	8
720p50	高	20	12
	中	14	9
	低	7	6

SD			
视频格式	比特率设置	比特率 (Mb/s) H.264	比特率 (Mb/s)H.265
625i50	高	18	11
	中	12	8
	低	6	6
525i59.94	高	20	12
	中	14	9
	低	7	6

触发

触发设置可启用触发记录功能, 让您可通过Blackmagic URSA Mini等其它SDI设备上的记录按钮来触发Blackmagic Duplicator 4K开始记录。

None (无)

选择“None”可禁用触发记录功能。

SDI Start/Stop (SDI开始/停止)

选择了SDI Start/Stop后, 一旦您按下其它SDI设备上的记录按钮, Blackmagic Duplicator 4K就会开始记录。

例如, Blackmagic URSA Mini总是通过SDI输出发送一个记录触发信号, 因此当您在摄影机上按下记录时, Blackmagic Duplicator 4K将开始记录, 并且可当您再次按下记录按钮时停止记录。您无需在URSA Mini上调整任何设置来启用触发记录功能。但是, 如果您使用的是其它支持触发记录功能的SDI设备, 并想要使用该设备来触发记录, 那么您需要通过该设备的设备菜单来启用SDI开始和停止记录功能。

Timecode Run (时间码运行)

如果您的SDI设备不支持SDI开始/停止触发记录, 那么可对Blackmagic Duplicator 4K进行设置, 让它一检测到时间码开始运行就立即开始记录。例如, 如果您将一台SDI摄影机连接到Blackmagic Duplicator 4K, 且摄影机设为“Record Run” (记录运行) 时间码, 那么它也将触发Blackmagic Duplicator 4K开始记录。当您在摄影机上停止记录, 时间码将停止运行, 此时Blackmagic Duplicator 4K上的记录也将停止。

这是一个非常棒的功能, 但您需要确保您设备的时间码设置已设为“Record Run” (记录运行)。如果时间码设为“Time of Day” (当天时间), 那么它将一直输出运行时间码, 从而一直触发Blackmagic Duplicator 4K上的记录功能, 而这并不是您所想要的情况。

格式化存储卡

通过Blackmagic Duplicator 4K上的格式化功能, 您可以同时格式化多达25张存储卡。

格式化存储卡的步骤如下:

- 1 按下控制面板上的“MENU” (菜单) 按钮, 打开LCD菜单。
- 2 按下“Record” (记录) 菜单软按钮, 打开记录设置。
- 3 按左右箭头软按钮导航到“Format Cards” (格式化存储卡) 设置, 然后按下“Format” (格式化)。
- 4 屏幕会弹出一条信息, 提示您确认格式化操作。您还将看到一条警告信息, 提醒您此操作无法撤销。如果您的SD卡上有任何您想要保存的数据, 请务必在执行此操作前进行备份。
- 5 按“Format” (格式化) 以确认此操作。您还可以按“Cancel” (取消) 回到“Record” (记录) 设置。
- 6 当您的存储卡进行格式化时, LED状态提示灯将闪烁黄色, LCD屏上将出现进度条。当存储卡格式化完毕后, 状态提示灯将保持绿色, 且LCD菜单将提示您格式化进程已完毕, 目前存储卡已就绪并可进行记录。
- 7 按下OK。然后在控制面板上按下“MENU” (菜单) 按钮, 退回到主页面。

设置

“Setting” (设置) 菜单可用于更改您Blackmagic Duplicator 4K的网络设置, 如DHCP开启或关闭、IP地址、子网掩码以及网关设置等。将Blackmagic Duplicator 4K连接到网络可让您通过Telnet等第三方管理软件远程控制设备。

开启DHCP

如果想要让Blackmagic Duplicator 4K连接到网络时自动配置最佳设置, 请选择“On” (开启)。这意味着您的Blackmagic Duplicator 4K将检查所有连接到网络中设备, 并设置其IP地址和其它网络设置, 从而避免潜在的设置冲突。这是一种值得信赖且简单快速的网络设置方法。

关闭DHCP

如果您想要全面手动控制您的网络设置, 可以将DHCP设为“Off” (关闭), 从而可以手动输入设置, 然后再通过导航更改IP地址、子网掩码以及网关等设置。

IP地址、子网掩码及网关

当DHCP设置“Off” (关闭) 时, 您可以手动更改这些设置。

编辑字段的步骤如下:

- 1 通过向左或向右菜单软按钮来选择想要更改的字段并按下“Change” (更改)。
- 2 按左右菜单软按钮来增加或降低数字的值。一直按住软按钮可快速移动数值。
- 3 按下“Set” (设置) 以确认更改。

如今您可以使用菜单软按钮在剩余的数字间移动, 并根据需要进行更改。



“Setting” (设置) LCD菜单用来更改网络设置, 以便您通过Telnet等第三方管理软件来控制Blackmagic Duplicator 4K。

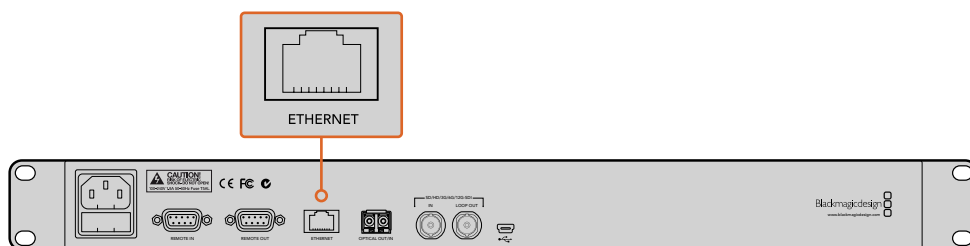

通过后面板上的以太网端口将Blackmagic Duplicator 4K连接到您的网络。

关于

此菜单设置提供了一个快速概要, 可向您显示当前的比特率设置、最近记录的文件名、网络状态以及Blackmagic Duplicator 4K的内部软件版本。

Blackmagic Duplicator Utility

更新Blackmagic Duplicator 4K

Blackmagic Duplicator Utility软件可用于Blackmagic Duplicator 4K的内部软件升级, 并且还能更改“文件名前缀”设置, 便于您为记录下来的文件添加标签。我们建议您下载并更新Blackmagic Duplicator 4K的软件, 以便获得最新功能和功能改进。

请到Blackmagic Design支持中心下载最新版本, 网址: www.blackmagicdesign.com/cn/support。

在macOS系统上更新内部软件步骤如下:

- 1 下载并解压缩Blackmagic Duplicator Utility实用程序。
- 2 打开生成的硬盘图标并运行Blackmagic Duplicator Utility Installer 安装程序。根据屏幕提示完成安装。
- 3 安装完最新Blackmagic Duplicator Utility软件后, 通过USB线缆将Blackmagic Duplicator 4K连接至您的计算机上。
- 4 运行Duplicator Utility实用程序, 点击圆形的设置图标并打开设项。如果该软件检测到Blackmagic Duplicator 4K上安装的是早前版本, 将会显示“Update Now” (立即更新) 的图标。只要点击该图标便可更新内部软件。如果您的Blackmagic Duplicator 4K已安装有最新内部软件, 那么您不必进行任何操作。

在Windows系统上更新内部软件步骤如下:

- 1 下载并解压缩Blackmagic Duplicator Utility实用程序。
- 2 您应该可以看到一个名为Blackmagic Duplicator Utility的文件夹, 该文件夹中含有本操作手册以及Blackmagic Duplicator Utility Installer安装程序。双击该安装程序, 并根据屏幕提示完成安装。
- 3 安装完最新Blackmagic Duplicator Utility软件后, 通过USB线缆将Blackmagic Duplicator 4K连接至您的计算机上。
- 4 运行Duplicator Utility实用程序, 点击圆形的设置图标并打开设项。如果该软件检测到Blackmagic Duplicator 4K上安装的是早前版本, 将会显示“Update Now” (立即更新) 的图标。只要点击该图标便可更新内部软件。如果您的Blackmagic Duplicator 4K已安装有最新内部软件, 那么您不必进行任何操作。

文件名前缀

您可以对文件名前缀进行更改, 以便为记录下来的文件添加标签加以识别。只需点击“File Name Prefix” (文件名前缀) 编辑框并键入新名称即可。完成该操作后, 当您的Blackmagic Duplicator 4K记录新的片段时, 其文件名就会以一个自定义名称加四位数字的形式来作为片段编号。这些数字将在每次记录片段时以升序编排。

如此一来, 您只要通过开启从属设备的远程按钮, 并更改主设备上的文件名前缀设置, 就能确保所有采用菊链式连接的设备上所记录的文件都使用相同的文件名。这样能有助于您在记录片段的同时确保所有设备上的所有存储卡都共享相同的文件名。

安装选购的Optical Fiber SDI Module

如果您想要通过光纤插入SDI视频, 那么您需要安装选购的Optical Fiber SDI Module光纤模块。任何SMPTE兼容SFP光纤模块都可从任意Blackmagic Design经销商处单独购买并安装。只要将该模块插入Blackmagic Duplicator 4K后面板上内置的光纤口即可使用。安装Optical Fiber SDI Module后, 您能以超长线缆距离连接内嵌音频的SDI视频。您还可以把光纤输出作为一个额外的环通视频接口所用。

如果您运行的是3G-SDI或6G-SDI光纤等较低速度的光纤系统并且不需要高速度的话, 您可在此光纤口安装较低速度的模块从而节省成本。

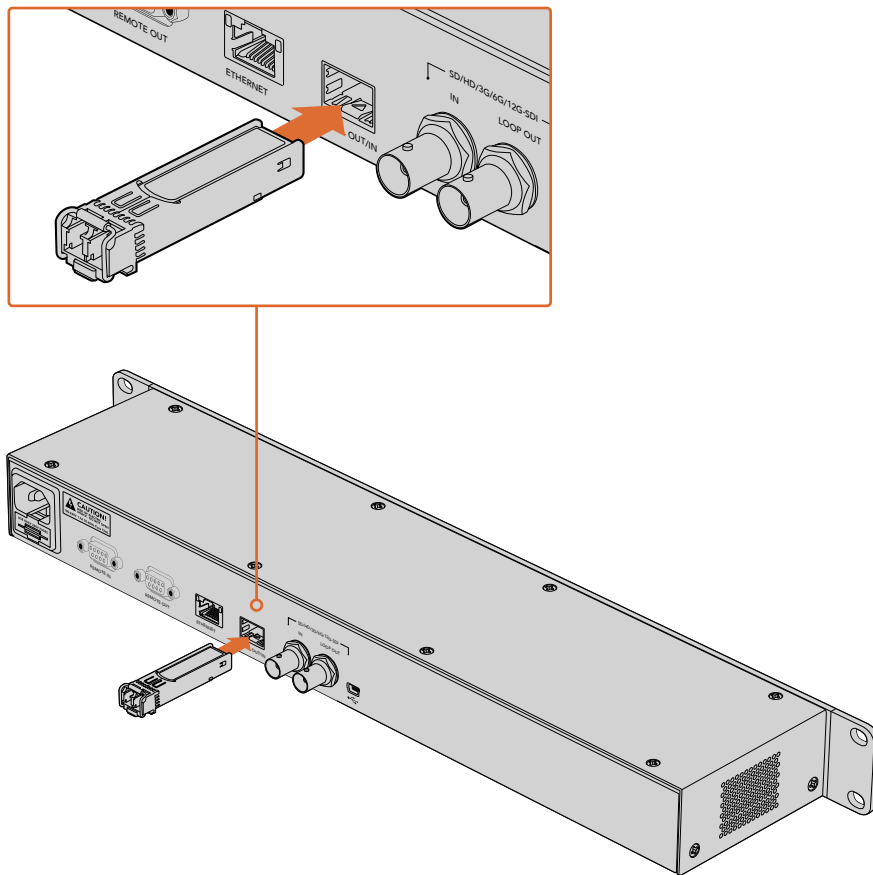

安装选购的Optical Fiber SDI Module后, 您可以通过光纤来连接SDI视频。

Blackmagic Duplicator 4K将使用首先插入的那个视频连接, 但如果同时连接有SDI和光纤, 那么您可在LCD菜单中通过“Video Source” (视频源) 设置来选择其一。详情请参阅“设置”部分的内容。

RS-422控制

什么是RS-422控制？

RS-422标准是串行录机控制广播级标准，自20世纪80年代早期开始便为众多播出机构用于各类录机、线性编辑工具、非编工具以及播出自动化产品。Blackmagic Duplicator 4K支持这一标准，因此可集成到播出自动化、远程控制系统、预定记录系统以及任何自行设计的定制控制方案当中。

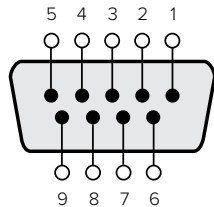

发射 (-)	发射 (+)	接收 (-)	接收 (+)	接地引脚
2	7	8	3	1, 4, 6, 9

用于远程输出接口的RS-422远程引脚连接。

使用外部RS-422控制器

Blackmagic Duplicator 4K配备工业标准的索尼 (tm) 兼容“REMOTE”RS-422录机控制端口，该端口配有正确的引脚连接，可直接连接到任何RS-422远程控制器。

您可以使用预加工的9针线缆，只要确保线缆两端均采用“引脚到引脚”的连线，且两端相同号码的引脚连接在一起即可。如果您的设备接线有所不同且想要自定义线缆，请参考附带的远程输出接线图，从而确保发射（即Tx）引脚连接到接收（即Rx）引脚上。

为您的Blackmagic Duplicator 4K连接外部RS-422控制器后，可通过远程控制来替代设备自身的按键操作。

- 1 用RS-422线缆将外部控制与Blackmagic Duplicator 4K的远程输入口相连。
- 2 在Blackmagic Duplicator 4K的控制面板上按下标有“REM”的远程按钮可启用远程录机控制。

现在您就可以远程控制Blackmagic Duplicator 4K进行开始和停止记录，或开始和停止合并记录。本章节后续名为“支持的RS-422命令”的表格列出了所有支持的RS-422命令。

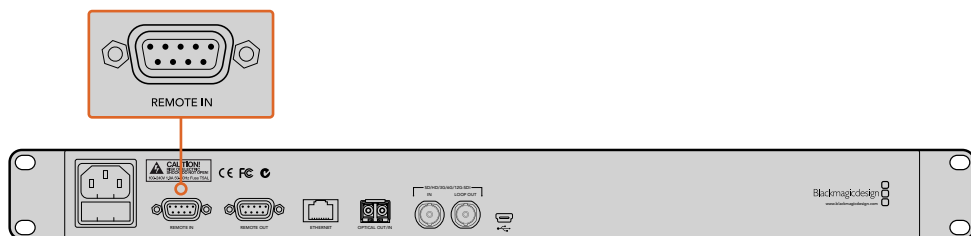

将外部RS-422控制器连接到Blackmagic Duplicator 4K的远程输入接口即可远程控制设备。

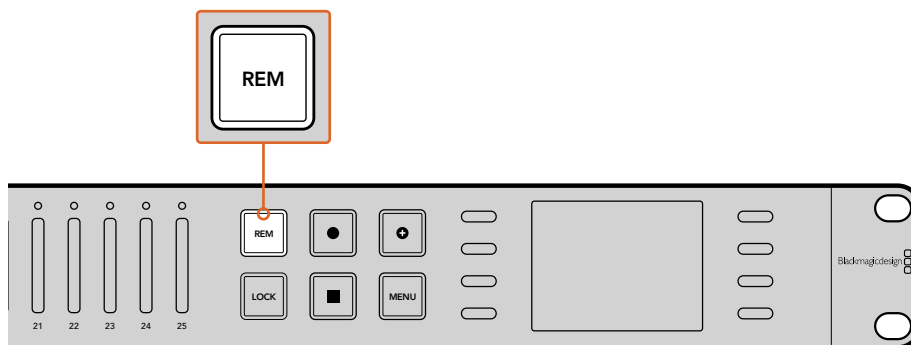

在Blackmagic Duplicator 4K的控制面板上按下远程按钮可启用RS-422录机控制。

Supported RS-422 Commands

Command			Reply	No Remote	Notes
0 - System Control					
0x00	0x11	DeviceTypeRequest	NTSC: 0xF0E0 PAL: 0xF1E0 24P: 0xF2E0	Enabled	
1 - Slave Response					
0x20	0x00	Stop	Acknowledge	Disabled	
0x20	0x02	Record	Acknowledge	Disabled	
0x21	0x02	Append	Acknowledge	Disabled	Non-standard command – an extra payload of 0x00 indicates append
4 - Preset/Select Control					
0x40	0x40	AutoMode Off	Acknowledge	Disabled	ignored, Status bit remembered
0x40	0x41	AutoMode On	Acknowledge	Disabled	ignored, Status bit remembered
0x61	0x20	StatusSense	StatusData	Enabled	
7 - Sense Reply					
0x70	0x20	StatusData	–	–	Please see “Status Bits” sheet: Limited to 9 bytes of status, silently truncated

RS-422 Developer Information

	Bit 7	Bit 6	Bit 5	Bit 4	Bit 3	Bit 2	Bit 1	Bit 0
Byte 0	0	0	Cassette out	0	0	0	0	Local
Byte 1	Standby	0	Stop	0	0	0	Record	0
Byte 2	0	0	0	0	0	0	0	0
Byte 3	Auto Mode	0	0	0	0	0	0	0
Byte 4	Select EE	Full EE	0	0	0	0	0	0
Byte 5	0	0	0	0	0	0	0	0
Byte 6	0	0	0	0	0	0	0	0
Byte 7	0	0	0	0	0	0	0	0
Byte 8	0	0	0	0	0	0	0	0
Byte 9	0	0	0	0	0	0	0	0

Variables	
Cassette Out	Set if no cards are ready to record
Local	Set if in local mode (no remote control)
Standby	Set if one or more cards are ready to record
Auto Mode	For compatibility only
Full EE	For compatibility only – always on
Select EE	For compatibility only – always on

Blackmagic Duplicator 4K RS-422 Settings	
Protocol	Based on Sony 9-pin protocol
Baud Rate	38.4 K
Start Bits	1
Data Bits	8
Stop Bits	1
Parity Bits	1
Parity Type	Odd

通过以太网远程控制

您可以通过以太网使用Blackmagic HyperDeck以太网协议中基于文本的命令从外部控制Blackmagic Duplicator 4K。此功能让您可以从计算机上通过Telnet等管理软件来远程控制您的Blackmagic Duplicator 4K，或者也可以自定义构建属于您自己的硬件控制面板，并通过HyperDeck以太网协议编程，将其与Blackmagic Duplicator 4K整合在一起。

您可以开发自己的自定义方案，从计算机或专门的硬件控制设备，以及从演播厅或转播车上内置的大型系统上控制复制机。例如，Arduino微控制器是一种小型电路板，可通过名为“Shield”（盾）的扩充板实现自定义功能。盾的种类繁多，而且还可以连接各种接口。控制Blackmagic Duplicator 4K需要以太网盾方可实现。您甚至还可以购买其他带有编程按钮功能的盾！Arduino微控制器设置简单、价格经济，而且还是完全的开源平台。当您编写完Arduino软件后，只要将Arduino连接到Blackmagic Duplicator 4K的以太网端口就可以立即开始控制您的复制机了。

Arduino控制示例

Arduino微控制器可通过常用的C语言编程。只要通过HyperDeck以太网协议对您的控制器进行编程，即可让它对Blackmagic Duplicator 4K触发各项命令。所有支持的命令都在名为“Blackmagic HyperDeck以太网协议”的后续部分列出。

您可以为Arduino添加其他的扩展盾，从而执行各种记录功能。例如，如果您添加一个内部计时器，就可以为控制器编程，让它在某个特定时间点命令Blackmagic Duplicator 4K进行记录，这一功能对于计划安保记录工作可能会很有帮助。

我们对这一技术感到非常激动，并希望能收到您关于构建各种外部以太网控制器的反馈！

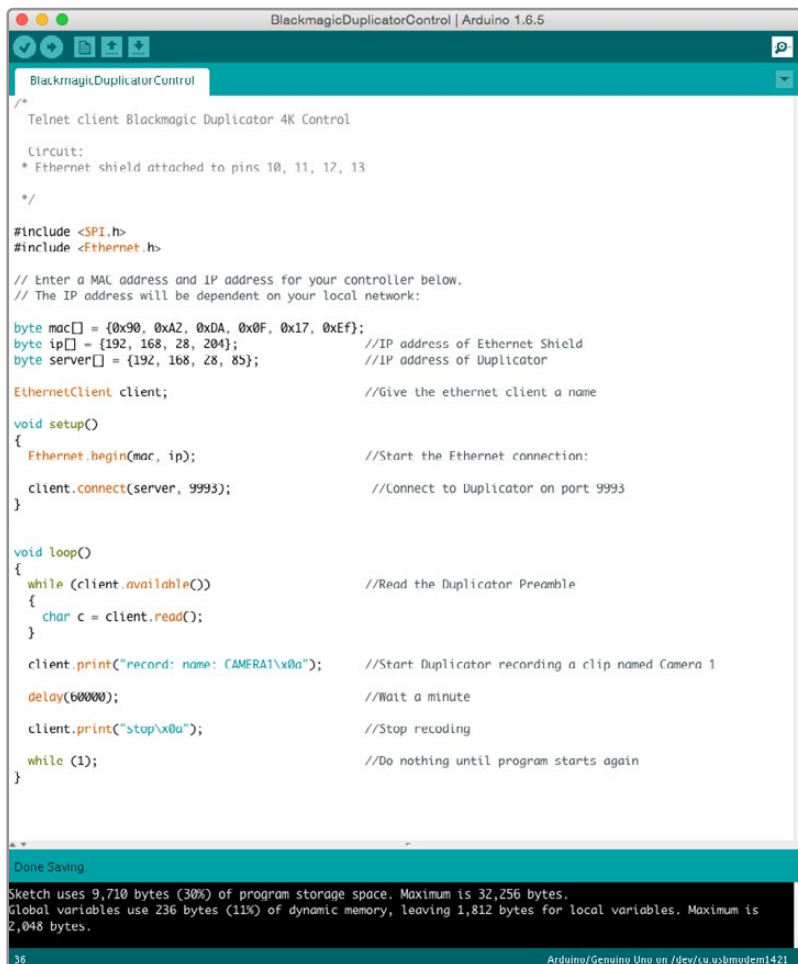

```
BlackmagicDuplicatorControl | Arduino 1.6.5

BlackmagicDuplicatorControl

/*
 * Telnet client Blackmagic Duplicator 4K Control
 */

Circuit:
 * Ethernet shield attached to pins 10, 11, 12, 13

*/

#include <SPI.h>
#include <Ethernet.h>

// Enter a MAC address and IP address for your controller below.
// The IP address will be dependent on your local network:

byte mac[] = {0x90, 0xA2, 0xDA, 0x0F, 0x17, 0xEF};
byte ip[] = {192, 168, 28, 204}; //IP address of Ethernet Shield
byte server[] = {192, 168, 28, 85}; //IP address of Duplicator

EthernetClient client; //Give the ethernet client a name

void setup()
{
  Ethernet.begin(mac, ip); //Start the Ethernet connection:
  client.connect(server, 9993); //Connect to Duplicator on port 9993
}

void loop()
{
  while (client.available()) //Read the Duplicator Preamble
  {
    char c = client.read();
  }

  client.print("record: name: CAMFRA1\x0a"); //Start Duplicator recording a clip named Camera 1
  delay(60000); //Wait a minute
  client.print("stop\x0a"); //Stop recoding
  while (1); //Do nothing until program starts again
}

Done Saving
Sketch uses 9,710 bytes (30%) of program storage space. Maximum is 32,256 bytes.
Global variables use 236 bytes (11%) of dynamic memory, leaving 1,812 bytes for local variables. Maximum is 2,048 bytes.
36 Arduino/Genuino Uno on /dev/tty.usbmodem1421
```

当为外部以太网控制器编程时，例如本例使用的是带有以太网盾的Arduino，您只要参考这里的以太网协议来选择需要哪个命令就可以实现您想要的控制。

上面窗口内显示的代码还出现在下一页中, 便于您将其复制粘贴到您的Arduino IDE中。为Arduino编写的这段代码可命令Blackmagic Duplicator 4K记录一分钟, 然后停止记录并等待, 直到程序再次运行。

```
/*
   Telnet client Blackmagic Duplicator 4K Control Circuit: *
Ethernet shield attached to pins 10, 11, 12, 13
*/
#include <SPI.h>
#include <Ethernet.h>

// Enter a MAC address and IP address for your controller below.
// The IP address will be dependent on your local network:
byte mac[] = {0x90, 0xA2, 0xDA, 0x0F, 0x17, 0xEF};
byte ip[] = {192, 168, 28, 204};           // IP address of
Ethernet Shield
byte server[] = {192, 168, 28, 141};      // IP address of Duplicator
EthernetClient client;                   // Give the ethernet
client a name

void setup()
{
  Ethernet.begin(mac, ip);               //Start the Ethernet connection:

  client.connect(server, 9993);          //Connect to Duplicator on port 9993
}

void loop()
{
  while (client.available()) //Read the Duplicator Preamble
  {
    char c = client.read();
  }
  client.print("record: name: Cameral\x0a");
  //Start Duplicator recording a clip named Camera 1
  delay(60000);                          //Wait a minute
  client.print("stop\x0a");               //Stop recoding
  while (1);                              //Do nothing until program
starts again
}
```

Blackmagic HyperDeck以太网协议

Blackmagic HyperDeck以太网协议是基于文本的协议，最初编写是为了通过以太网端口控制Blackmagic HyperDeck硬盘录机的，但您还可以将相同的协议用于控制您的Blackmagic Duplicator 4K。

由于复制机只进行记录，不需要用到Hyperdeck协议的所有命令，因此这部分显示了与复制机相关的HyperDeck以太网协议中可用的命令。

Protocol Commands

Command	Command Description
help or ?	Provides help text with all commands and parameters.
remote	Queries the state of HyperDeck's remote control mode.
remote: enable: true	Enables remote control.
remote: enable: false	Disables remote control.
remote: override: true	Turns remote override on.
remote: override: false	Turns remote override off.
quit	Disconnects HyperDeck server.
ping	Determines HyperDeck server is responding.
record	Starts recording.
record: append: true	Starts appended recording.
stop	Stops playback or recording.
commands	Lists all supported commands in an XML format.
notify	Queries the current state of all notifications.
notify: transport: true	Enables transport notifications.
notify: transport: false	Disables transport notifications.
notify: slot: true	Enables slot notifications.
notify: slot: false	Disables slot notifications.
notify: remote: true	Enables remote notifications.
notify: remote: false	Disables remote notifications.
notify: configuration: true	Enables configuration notifications.
notify: configuration: false	Disables configuration notifications.
notify: dropped frames: true	Enables dropped frames notifications.
notify: dropped frames: false	Disables dropped frames notifications.
device info	Provides device information.
slot info: slot id: {slot ID}	Provides information about a specified slot.
transport info	Provides information for the state of the transport.
configuration	Queries the current configuration.
configuration: record mode: Duplicate	Configures the record mode to duplicate.

Command	Command Description
configuration: record mode: SingleDisk	Configures the record mode to single disk.
configuration: record mode: DiskOverwrite	Configures the record mode to disk overwrite.
configuration: video input: {"SDI", "optical"}	Configures video input.
configuration: file format: {format}	Configures the record codec and bit rate.
format: prepare: {format}	prepare a disk formatting operation to filesystem {format}
format: confirm: {token}	perform a pre-prepared formatting operation using token
watchdog: period: {seconds}	Configures the watchdog.

Using XML

While you can use the Terminal to talk to HyperDeck, if you are writing software you can use XML to confirm the existence of a specific command based on the firmware of the HyperDeck you are communicating with. This helps your software user interface adjust to the capabilities of the specific HyperDeck model and software version.

Protocol Details

Connection

The HyperDeck Ethernet server listens on TCP port 9993.

Basic syntax

The HyperDeck protocol is a line oriented text protocol. Lines from the server will be separated by an ASCII CR LF sequence. Messages from the client may be separated by LF or CR LF.

New lines are represented in this document as a "↵" symbol.

Command syntax

Command parameters are usually optional. A command with no parameters is terminated with a new line:

```
{Command name}↵
```

If parameters are specified, the command name is followed by a colon, then pairs of parameter names and values. Each parameter name is terminated with a colon character:

```
{Command name}: {Parameter}: {Value} {Parameter}: {Value} ...↵
```

Response syntax

Simple responses from the server consist of a three digit response code and descriptive text terminated by a new line:

```
{Response code} {Response text}↵
```

If a response carries parameters, the response text is terminated with a colon, and parameter name and value pairs follow on subsequent lines until a blank line is returned:

```
{Response code} {Response text}:↵
{Parameter}: {Value}↵
{Parameter}: {Value}↵
...
↵
```

Successful response codes

A simple acknowledgement of a command is indicated with a response code of 200:

```
200 ok↵
```

Other successful responses carry parameters and are indicated with response codes in the range of 201 to 299.

Failure response codes

Failure responses to commands are indicated with response codes in the range of 100 to 199:

```
100 syntax error
101 unsupported parameter
102 invalid value
103 unsupported
104 disk full
105 no disk
106 disk error
109 out of range
110 no input
111 remote control disabled
120 connection rejected
150 invalid state
```

Asynchronous response codes

The server may return asynchronous messages at any time. These responses are indicated with response codes in the range of 500 to 599:

```
5xx {Response Text}:↵
{Parameter}: {Value}↵
{Parameter}: {Value}↵
↵
```

Connection response

On connection, an asynchronous message will be delivered:

```
500 connection info:↵
protocol version: {Version}↵
model: {Model Name}↵
↵
```

Connection rejection

Only one client may connect to the server at a time. If other clients attempt to connect concurrently, they will receive an error and be disconnected:

```
120 connection rejected↵
```

Timecode syntax

Timecodes are expressed as non-drop-frame timecode in the format:

```
HH:MM:SS:FF
```

Handling of deck "remote" state

The "remote" command may be used to enable or disable the remote control of the deck. Any attempt to change the deck state over ethernet while remote access is disabled will generate an error:

```
111 remote control disabled↵
```

To enable or disable remote control:

```
remote: enable: {"true", "false"} ↵
```

The current remote control state may be overridden allowing remote access over ethernet irrespective of the current remote control state:

```
remote: override: {"true", "false"} ↵
```

The override state is only valid for the currently connected ethernet client and only while the connection remains open.

The "remote" command may be used to query the remote control state of the deck by specifying no parameters:

```
remote↵
```

The deck will return the current remote control state:

```
210 remote info:↵
enabled: {"true", "false"}↵
override: {"true", "false"}↵
↵
```

Asynchronous remote control information change notification is disabled by default and may be configured with the "notify" command. When enabled, changes in remote state will generate a "510 remote info:" asynchronous message with the same parameters as the "210 remote info:" message.

Closing connection

The "quit" command instructs the server to cleanly shut down the connection:

```
quit↵
```

Checking connection status

The "ping" command has no function other than to determine if the server is responding:

```
ping↵
```

Getting help

The "help" or "?" commands return human readable help text describing all available commands and parameters:

```
help↵
```

or:

```
?↵
```

The server will respond with a list of all supported commands:

```
201 help:↵
{Help Text}↵
{Help Text}↵
↵
```

Stopping deck operation

The "stop" command instructs the deck to stop the current capture:

```
stop↵
```

Enumerating supported commands and parameters

The "commands" command returns the supported commands:

```
commands↵
```

The command list is returned in a computer readable XML format:

```
212 commands:
<commands>↵
    <command name="..."><parameter name="...">...</command>↵
    <command name="..."><parameter name="...">...</command>↵
    ...
</commands>↵
↵
```

More XML tokens and parameters may be added in later releases.

Controlling asynchronous notifications

The "notify" command may be used to enable or disable asynchronous notifications from the server. To enable or disable transport notifications:

```
notify: transport: {"true", "false"}↵
```

To enable or disable slot notifications:

```
notify: slot: {"true", "false"}↵
```

To enable or disable remote notifications:

```
notify: remote: {"true", "false"}↵
```

To enable or disable configuration notifications:

```
notify: configuration: {"true", "false"}↵
```

To enable or disable dropped frames notifications:

```
notify: dropped frames: {"true", "false"}↵
```

Multiple parameters may be specified. If no parameters are specified, the server returns the current state of all notifications:

```
209 notify:↵
transport: {"true", "false"}↵
slot: {"true", "false"}↵
remote: {"true", "false"}↵
configuration: {"true", "false"}↵
↵
```

Retrieving device information

The "device info" command returns information about the connected deck device:

```
device info↵
```

The server will respond with:

```
204 device info:↵
protocol version: {Version}↵
model: {Model Name}↵
unique id: {unique alphanumeric identifier}↵
↵
```

Example of response from server:

```
204 device info:↵
protocol version: 1.8↵
model: Blackmagic Duplicator 4K↵
unique id: 101112131415↵
↵
```

Retrieving slot information

The "slot info" command returns information about a slot.

The specified slot will be queried:

```
slot info: slot id: {Slot ID}↵
```

The server will respond with slot specific information:

```
202 slot info:↵
slot id: {Slot ID}↵
status: {"empty", "mounting", "error", "mounted"}↵
volume name: {Volume name}↵
recording time: {recording time available in seconds}↵
video format: {disk's default video format}↵
↵
```

Asynchronous slot information change notification is disabled by default and may be configured with the “notify” command. When enabled, changes in slot state will generate a “502 slot info:” asynchronous message with the same parameters as the “202 slot info:” message.

Retrieving transport information

The “transport info” command returns the state of the transport:

```
transport info ↵
```

The server responds with transport specific information:

```
208 transport info:↵  
status: {"stopped","record"}↵  
display timecode: {timecode}↵  
timecode: {timecode}↵
```

The “timecode” value is the timecode within the current timeline for playback or the clip for record. The “display timecode” is the timecode displayed on the front of the deck. The two timecodes will differ in some deck modes.

Asynchronous transport information change notification is disabled by default and may be configured with the “notify” command. When enabled, changes in transport state will generate a “508 transport info:” asynchronous message with the same parameters as the “208 transport info:” message.

Video Formats

The following video formats are currently supported on Blackmagic Duplicator 4K:

SD

525i59.94 NTSC
625i50 PAL

HD

720p50	1080p30
720p59.94	1080i50
720p60	1080p50
1080p23.98	1080i59.94
1080p24	1080p59.94
1080p25	1080i60
1080p29.97	1080p60

Ultra HD

2160p23.98	2160p30
2160p24	2160p50
2160p25	2160p59.94
2160p29.97	2160p60

Duplicator 4K supports progressive segmented frame modes, and automatically detects level A and level B 3G-SDI formats for 1080p50, 1080p59.94 and 1080p60.

File Formats

Duplicator 4K supports the following file formats:

- H.264Low
- H.264Medium
- H.264High
- H.265Low
- H.265Medium
- H.265High

Querying and updating configuration information

The "configuration" command may be used to query the current configuration of the deck:

```
configuration↵
```

The server returns the configuration of the deck:

```
211 configuration:↵  
video input: {"SDI", "optical"}↵  
↵
```

One or more configuration parameters may be specified to change the configuration of the deck.

To change the current video input:

```
configuration: video input: {"SDI", "optical"}↵
```

Configuring the watchdog

The "watchdog" command instructs the deck to monitor the connected client and terminate the connection if the client is inactive for at least a specified period of time.

To configure the watchdog:

```
watchdog: period: {period in seconds}↵
```

To avoid disconnection, the client must send a command to the server at least every {period} seconds. Note that if the period is set to 0 or less than 0, connection monitoring will be disabled.

Configuring the record mode

Use the 'record mode' command to select the deck recording mode:

```
configuration: record mode: {"Duplicate", "SingleDisk", "DiskOverwrite"}↵
```

Configuring the file format

The 'file format' command instructs the deck to switch to a specific file format for codec and bit rate:

```
configuration: file format: {"H.264High", "H.264Medium", "H.264Low",  
"H.265High", "H.265Medium", "H.265Low"}↵
```

帮助

获得帮助

获得帮助最快捷的方法是登陆Blackmagic Design在线支持页面, 浏览Blackmagic Duplicator 4K的相关最新支持材料。

Blackmagic Design在线支持页面

请登陆Blackmagic Design支持中心www.blackmagicdesign.com/cn/support获得最新版操作手册、软件以及技术答疑文章。

Blackmagic Design论坛

您可以登陆我们的网站访问Blackmagic Design论坛, 获得更多信息和有用的创意资源。访问论坛也是获取帮助的一个捷径, 因为论坛中不乏经验丰富的用户和Blackmagic Design的员工, 他们都能为您解答疑惑。请登陆网址<http://forum.blackmagicdesign.com>进入论坛。

联系Blackmagic Design支持中心

如果我们提供的支持信息和论坛均无法解答您的疑问, 请到支持页面下点击“给我们发送电子邮件”按钮即可发送技术支持请求。或者, 您也可以点击支持页面下的“查找您所在地区的支持团队”按钮, 致电您所在地区的Blackmagic Design支持中心获得帮助。

查看当前安装的软件版本

要检查您的电脑当前安装的Blackmagic Duplicator Utility软件版本, 请打开About Blackmagic Duplicator Utility窗口查看。

- 在macOS系统下, 请到“应用程序”文件夹下打开Blackmagic Duplicator Utility。点击文件夹中的Blackmagic Duplicator Utility后即可查看版本号。
- 在Windows 8.1系统下, 请到开始页面从Blackmagic Duplicator Utility选项卡打开Blackmagic Duplicator Utility。点击Help (帮助) 菜单并选择About Blackmagic Duplicator Utility即可查看版本号。
- 在Windows 10系统下, 请到开始菜单打开Blackmagic Duplicator Utility。点击Help (帮助) 菜单并选择About Blackmagic Duplicator Utility即可查看版本号。

如何获得软件更新

检查完您电脑上安装的Blackmagic Duplicator Utility软件版本号之后, 请登录网址www.blackmagicdesign.com/cn/support访问Blackmagic Design支持中心查看最新版本。请及时将软件升级到最新版本, 但切勿在重要项目制作过程中升级软件。

监管告知

在欧盟范围内处置电子垃圾和电子设备的注意事项。



根据产品所附的提示标志，本设备不得与其它废弃材料共同处置。处置废弃设备时，必须交给指定收集点进行回收。对废弃设备进行单独收集并回收能够节省自然资源，且回收方式不会损害环境和人体健康。获取更多关于废弃设备回收点的信息，请联系您所在城市的回收站，或当时购买设备的经销商。



本设备经过测试，符合FCC规则的第15部分对A类数字设备的限制。这些限制旨在为运行于商业环境中的设备提供合理保护，使其免受有害干扰的影响。本设备可生成、使用且辐射射频能量，如果未按照安装手册来安装和使用本设备，则可能导致对无线电通信的有害干扰。在住宅区运行本产品可能会产生有害干扰，在这种情况下将由用户自行承担消除干扰的费用。

必须满足以下条件后方可操作：

- 1 设备不会造成有害干扰。
- 2 设备必须接受任何受到的干扰，包括可能导致意外操作的干扰。

加拿大ISED认证声明

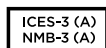

本设备符合加拿大A类数码产品的相关标准。

任何对本产品的改装或预期用途之外的使用均可能导致相关标准认证无效。

本设备经检测符合商业环境使用要求。在家用环境中，本设备可能会造成无线电干扰。

安全信息

为避免触电，设备必须连接在配有保护地线的电源插座。如有疑问，请与具有相关资质的电工进行确认。

为了降低触电风险，请勿将设备放在会滴水或溅水的地方。

本产品适合在环境温度低于40°C的热带地区使用。

确保设备四周留有足够的空间，不受阻碍。

安装在机架上时，确保相邻设备不会阻碍通风。

设备内部没有操作人员可维护的零件。维修服务请联系当地Blackmagic Design服务中心。

一些产品具有连接小型收发器 (SFP) 光纤模块的功能。仅使用Laser Class 1光纤SFP模块。

建议使用的Blackmagic Design SFP模块：

- 3G-SDI: PL-4F20-311C
- 6G-SDI: PL-8F10-311C
- 12G-SDI: PL-TG10-311C



请在海平面高度为2000米以下的地区使用。

加利福尼亚安全声明

该产品含有六价铬在内的化学物质，被加州政府认定为可能导致癌症、先天畸形或其他遗传危害的物质。

详情请访问网址www.P65Warnings.ca.gov。

授权维修人员警告

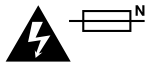

注意 — 双极/中线熔断

设备电源配有火线和中性线，适合连接挪威的IT配电系统。

保修

12个月有限保修

Blackmagic Design保证Blackmagic Duplicator 4K产品自购买之日起12个月内不会有材料和工艺上的缺陷。若本产品在保修期内出现质量问题, Blackmagic Design可选择为产品提供免费修理或更换零部件, 或者更换缺陷产品。

为确保消费者有权享受本保修条款中的服务, 如遇产品质量问题请务必在保修期内联系Blackmagic Design并妥善安排保修事宜。消费者应将缺陷产品包装并运送到Blackmagic Design的指定服务中心进行维修, 运费由消费者承担并预先支付。若消费者因任何原因退货, 所有运费、保险费、关税等各项税务以及其他费用均由消费者承担。

本保修条款不适用于任何因使用、维护不当或保养不周造成的缺陷、故障或损坏。根据本保修服务, Blackmagic Design的保修服务范围不包括以下内容: 1. 对由非Blackmagic Design专门人员进行的安装、维修或保养所造成的损坏进行维修, 2. 对因使用不当或连接到不兼容设备所造成的损坏进行维修, 3. 对因使用了非Blackmagic Design生产的零部件所导致的损坏或故障进行维修, 及 4. 对经过改装或和其他产品进行组装的产品进行保养维修(因为产品经改装或组装后会增加保养维修所需时间或保养难度)。本保修条款由BLACKMAGIC DESIGN提供, 它可取代所有其他明示或隐含的保修。BLACKMAGIC DESIGN及其供应商对任何有关适销性及就特定用途的适用性等隐含保证不作任何担保。BLACKMAGIC DESIGN负责为消费者提供缺陷产品的维修或更换服务是完整和排他性补救措施, 不论BLACKMAGIC DESIGN或其供应商是否事先获悉发生间接、特殊、偶然或必然损坏等损坏的可能性。若消费者对本设备进行非法使用, BLACKMAGIC DESIGN概不负责。对因使用本产品造成的损失, BLACKMAGIC DESIGN概不负责。本产品的操作风险由用户自行承担。

© Copyright 2019 Blackmagic Design 版权所有。“Blackmagic Design”、“DeckLink”、“HDLINK”、“Workgroup Videohub”、“Multibridge Pro”、“Multibridge Extreme”、“Intensity”以及“Leading the creative video revolution”在美国及其他国家均为注册商标。所有其他公司名称及产品名称可能是其他所有者的注册商标。Thunderbolt及其商标为英特尔公司在美国和/或其他国家的商标。

Blackmagicdesign



설치 및 사용 설명서

Blackmagic Duplicator 4K

2019년2월

한국어



환영합니다.

Blackmagic Duplicator 4K를 구매해 주셔서 감사합니다.

저희는 Blackmagic Duplicator 4K가 고화질의 Ultra HD 콘텐츠를 고객들에게 직접 분배할 수 있는 완벽한 솔루션이라 생각하며 이번 제품에 대한 기대가 상당히 높습니다. Blackmagic Duplicator는 널리 사용되는 H.264 또는 최신 H.265 압축 방식을 사용해 25개의 SD 카드에 최대 2160p60의 모든 SD 및 HD, Ultra HD 포맷으로 녹화할 수 있으며, 놀라운 화질과 높은 프레임 레이트를 낮은 데이터 전송률로 얻을 수 있어 저렴하고 장시간 녹화가 가능한 카드를 사용할 수 있습니다.

Blackmagic Duplicator 4K는 설치 및 사용이 간편합니다. 전면 패널에는 내장 LCD와 제어 패널이 탑재되어 있어 버튼을 사용해 설정을 변경하고 기기를 제어할 수 있을 뿐만 아니라, 이더넷 및 RS-422 컨트롤러를 통해 듀플리케이터를 원격으로도 제어할 수 있습니다. 원하는 컨트롤러를 만들어 Blackmagic HyperDeck 이더넷 프로토콜을 통해 기기를 제어할 수도 있습니다.

내장된 실시간 H.265 비디오 인코더를 통해 고화질 비디오를 저렴한 가격의 SD 카드에 최대 2160p60의 UHD로 녹화할 수 있어, 초고속 카드를 사용하지 않고도 놀라운 UHD 비디오를 녹화할 수 있습니다. 최신 Blackmagic Duplicator 4K 버전 1.2 소프트웨어를 통해 H.264 압축 기능을 추가할 수 있어 더욱 높은 호환성을 제공하는 H.264 파일로 녹화할 수 있습니다.

Blackmagic Duplicator 4K는 1RU 사이즈로 여러 대의 기기를 데이지 체인으로 연결해 휴대용 장비랙 시스템에 설치하면 촬영 현장에서도 사용할 수 있어, 동시에 수백 개의 SD 카드에 녹화할 수 있습니다.

본 사용 설명서에는 Blackmagic Duplicator 4K 사용에 필요한 모든 정보가 담겨있습니다.

자사의 웹사이트 www.blackmagicdesign.com/kr 고객지원 페이지에서 Blackmagic Duplicator 4K의 최신 버전 설명서와 소프트웨어 업데이트를 확인하실 수 있습니다. 소프트웨어 업데이트를 통해 모든 새로운 기능을 이용하실 수 있습니다. 소프트웨어를 다운로드할 때 사용자 정보를 등록하시면, 새로운 소프트웨어가 출시될 때마다 업데이트 소식을 받아보실 수 있습니다. 저희는 새로운 기능과 제품 향상을 위해서 끊임없이 노력하고 있으며, 항상 고객 여러분의 의견을 기다립니다!

Blackmagic Design의 CEO 그랜트 패티

목차

Blackmagic Duplicator 4K

시작하기	228
전원 연결하기	228
비디오 및 오디오 연결하기	228
데이터 체이닝	229
SD 카드 삽입 및 포맷하기	230
녹화	231
녹화 모드 설정하기	231
코덱 설정하기	232
비트 전송률 설정하기	233
클립 녹화하기	234
LED 상태 표시등	234
합치기 녹화	235
Blackmagic Duplicator 4K 잠금 기능	236
여러 대의 Duplicators 데이터 체이닝으로 연결하기	236
LCD 메뉴 설정	238
녹화(Record)	238
설정(Settings)	243
정보>About)	244
Blackmagic Duplicator Utility	244
Blackmagic Duplicator 4K 업데이트하기	244
파일명 접두사	244
Optical Fiber SDI Module 옵션 설치하기	245
RS-422 컨트롤	246
RS-422 컨트롤이란?	246
외부 RS-422 컨트롤러 사용하기	246
RS-422 Developer Information	248
이더넷을 통한 원격 제어	248
아두이노를 통한 제어 예시	249
Blackmagic HyperDeck 이더넷 프로토콜	251
Protocol Details	252
Configuring the watchdog	257
Configuring the record mode	257
Configuring the file format	257
지원	258
규제 사항	259
안전 정보	260
보증	261

시작하기

Blackmagic Duplicator 4K의 사용 준비는 간단합니다!

전원을 연결하고 SDI 비디오 소스를 연결한 뒤, 최대 25개의 SD 카드만 삽입하면 됩니다. 여러 대의 Blackmagic Duplicator 4K를 데이지 체이닝으로 연결하여 사용하면 더 많은 SD 카드에 녹화할 수 있으며, 다른 유닛에 연결할 수 있는 비디오 및 컨트롤 연결이 내장되어 있어 쉽게 연결할 수 있습니다. 이 부분에서는 Blackmagic Duplicator 4K 설정 방법이 정확하게 소개되어 있어 바로 여러 개의 SD 카드에 동시 녹화를 시작할 수 있습니다.

전원 연결하기

Blackmagic Duplicator 4K 뒷면 패널에 있는 110-240V AC 전원 입력에 표준 IEC 전원 코드를 연결해 전원을 공급합니다.

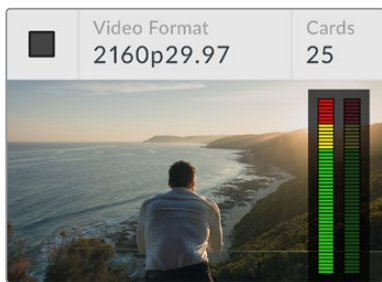

Blackmagic Duplicator 4K에 전원이 공급되면 내장 LCD에 시작 화면이 나타납니다.

시작 화면

시작 화면에는 소스 비디오 포맷이나 삽입된 SD 카드 개수, 녹화 중 및 녹화 종료를 알리는 상태 표시기, 오디오 미터 등의 소스 비디오 영상과 이에 대한 정보 뿐만 아니라 오디오 미터가 나타나므로 소스 비디오의 오디오 레벨을 모니터링할 수 있습니다.

비디오 및 오디오 연결하기

소스 비디오를 뒷면 패널의 12G-SDI에 연결하세요. Blackmagic Duplicator 4K는 입력 포맷을 자동으로 감지해 LCD 시작 화면에 표시합니다.

SDI 입/출력 BNC 커넥터는 최대 12G-SDI의 비디오 신호를 지원하므로 싱글 BNC 케이블 연결로 최대 2160p60의 SD/HD/UHD 비디오를 연결할 수 있습니다. 다시 말해, 해당 루프 출력이 소스 비디오 포맷과 항상 일치해 다른 SDI 비디오 장비 또는 데이지 체이닝으로 연결된 여러 대의 Blackmagic Duplicator 4K 사용 시 동일한 신호를 한 번에 출력해 낼 수 있습니다. PsF(Progressive Segmented Frames) 모드 또한 지원하므로 1080p50/1080p59.94/1080p60을 위한 레벨 A 및 레벨 B의 3G-SDI 포맷을 자동으로 감지합니다.

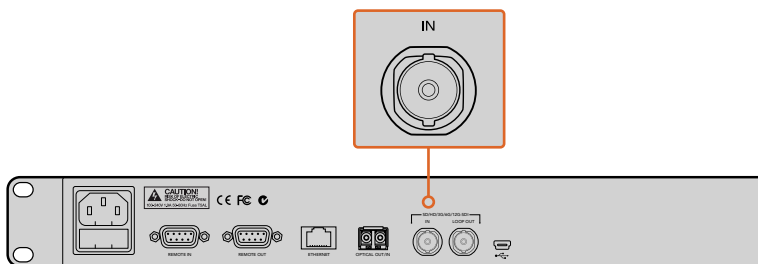

소스 비디오를 SDI 입력 커넥터에 연결하세요. 오디오는 SDI 비디오 신호에 임베디드됩니다.

Blackmagic Duplicator 4K는 2채널의 임베디드 SDI 오디오를 지원하므로 SDI 비디오 입력을 통해 이미 연결된 경우에는 오디오를 따로 입력할 필요가 없습니다.

정보 LCD 시작 화면에서 소스 비디오의 오디오 레벨을 모니터링할 수 있습니다.

데이터 체이닝

여러 대의 Blackmagic Duplicator 4K를 데이터 체이닝으로 연결할 수 있어 더 많은 SD 카드에 녹화할 수 있습니다. 예를 들면, 4대의 기기를 데이터 체이닝으로 연결하면 100개의 카드를 복사할 수 있습니다.

- 1 첫 번째 Blackmagic Duplicator 4K의 RS-422 REMOTE 출력을 두 번째 유닛의 REMOTE 입력에 연결하세요. 동일한 방법을 적용해 나머지 유닛도 연결합니다.
- 2 마찬가지로, 첫 번째 유닛의 루프 SDI 출력을 두 번째 유닛의 SDI 입력에 연결한 뒤, 나머지 유닛도 같은 방법으로 연결합니다.
- 3 각 제품의 제어 패널에는 REM이라고 표시된 버튼이 있습니다. 이는 Remote 버튼으로 유닛 간의 원격 제어 기능을 사용하려면 반드시 켜져 있어야 합니다. 두 번째 Blackmagic Duplicator 4K부터 마지막 기기까지 해당 리모트 버튼을 모두 차례대로 누르세요.

참고 데이터 체이닝으로 연결된 모든 기기의 제어는 Blackmagic Duplicator 4K에서 이루어지므로 첫 번째 기기의 Remote 버튼이 꺼져있는지 반드시 확인하세요. Remote 버튼이 꺼져 있는 첫 번째 기기는 마스터 기기로, 전면 패널의 버튼을 누르면 REMOTE OUT을 통해 해당 버튼의 신호가 출력되며, 이를 통해 Remote 버튼이 켜져 있는 두 번째 기기를 제어할 수 있습니다. RS-422 데크 컨트롤을 지원하는 모든 TV 제품의 원격 프로토콜은 산업 표준 데크 컨트롤 포맷이므로 마스터 기기로 사용할 수 있습니다.

이제 데이터 체이닝으로 연결된 모든 Blackmagic Duplicator 4K는 첫 번째 기기의 명령을 따를 준비가 완료되었습니다.

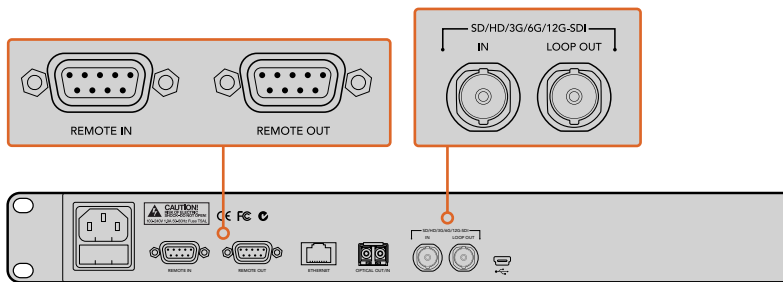

리모트 커넥터와 루프 커넥터를 사용해 여러 대의 Blackmagic Duplicator 4K를 데이터 체이닝으로 연결할 수 있습니다. 데이터 체이닝으로 연결된 마지막 기기의 루프 커넥터를 통해 Blackmagic SmartView 모니터나 HyperDeck 디스크 리코더 등의 다른 SDI 장비에 소스 비디오를 루프할 수 있습니다.

여러 대의 기기를 데이터 체이닝으로 연결하는 방법과 관련한 더 자세한 정보는 [여러 대의 Duplicators 데이터 체이닝으로 연결하기] 부분을 참고하세요.

SD 카드 삽입 및 포맷하기

Blackmagic Duplicator 4K는 일반적인 클래스 10 SD 카드를 사용하므로 반드시 초고속 카드를 사용할 필요가 없습니다. SD 카드는 카메라 장비를 판매하는 모든 상점에서 구입할 수 있으며, 일부 슈퍼마켓에서 클래스 10 SD 카드를 판매하기도 합니다.

정보 모든 SD 카드의 라벨 부분에는 작은 동그라미 안에 1부터 10사이의 숫자를 확인할 수 있습니다. 이 숫자는 카드의 속도율을 나타내며 10이 가장 빠른 속도율입니다. 동그라미 안 숫자가 10인 모든 카드는 클래스 10 SD 카드로 가장 빠른 비트 전송률로 설정된 최대 Ultra HD 비디오를 녹화하기 위해 필요한 카드 종류입니다.

SD 카드 삽입 방법

- 1 SD 카드의 금속 커넥터 부분이 컨트롤 패널의 LCD 화면 쪽을 향하도록 잡고, Blackmagic Duplicator 4K의 SD 카드 슬롯 중 한 곳에 잘 맞춥니다.
- 2 카드가 완전히 장착될 때까지 부드럽게 밀어 넣습니다. Blackmagic Duplicator 4K에서 카드 확인 과정이 빠르게 이루어지며 카드 사용 준비가 완료되면 카드 슬롯 위에 나타나는 상태 표시 LED에 초록불이 들어옵니다.

SD 카드의 금속 커넥터 부분이 LCD 화면 쪽을 향하도록 잘 맞추고, 카드가 완전히 장착될 때까지 부드럽게 밀어 넣습니다. 카드의 녹화 준비가 완료되면 LED 상태 표시장치에 초록불이 들어옵니다.

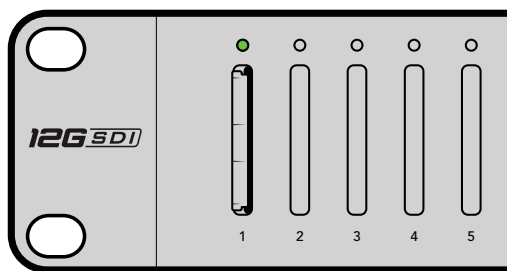
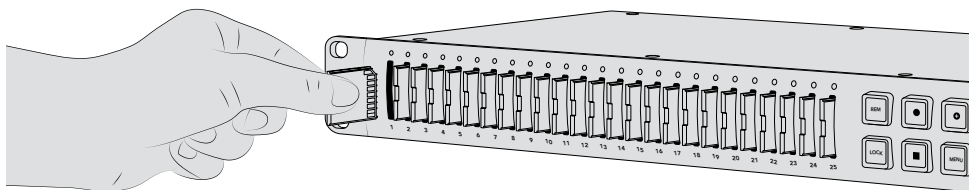

SD 카드의 금속 커넥터 부분이 LCD 화면 쪽을 향하도록 잘 맞추고, 카드가 완전히 장착될 때까지 부드럽게 밀어 넣습니다. Blackmagic Duplicator 4K에서 카드를 확인하는 동안 LED 상태 표시등이 녹색으로 깜빡이며, 카드에 녹화 준비가 완료되면 깜빡임이 멈춥니다.

카드의 가장자리 부분을 잡아당기면 슬롯에서 카드를 쉽게 제거할 수 있습니다.

정보 카드를 삽입할 시, 쓰기 방지가 해제되어 있는지 반드시 확인하세요. 쓰기 방지 기능은 카드 왼쪽 측면에 있는 작은 플라스틱 스위치를 커넥터와 가장 가까운 쪽으로 옮겨 해제할 수 있습니다. 녹화가 끝나면 스위치를 다시 아래쪽으로 옮겨 쓰기 방지 기능을 사용할 수 있습니다.

SD 카드 포맷하기

녹화를 시작하기 전에 SD 카드를 exFAT로 포맷해야 합니다. exFAT 포맷은 macOS와 Windows 컴퓨터에서 호환됩니다. Blackmagic Duplicator 4K의 Format 기능을 사용해 미디어를 쉽게 포맷할 수 있으며, 한 대의 기기에서 최대 25개의 SD 카드를 동시에 포맷할 수 있습니다.

Blackmagic Duplicator 4K에서 SD 카드를 포맷하기

- 1 컨트롤 패널에 있는 MENU 버튼을 누르세요.
- 2 LCD 화면 양쪽에 불이 들어 온 소프트 메뉴 버튼을 사용해 Record를 선택하세요.
- 3 왼쪽 화살표에 해당하는 소프트 버튼을 눌러 Format Cards 설정으로 들어간 뒤, LCD 메뉴 우측 하단에 있는 Format을 누르세요.
- 4 포맷 확인을 묻는 경고 메시지가 나타납니다. Format 소프트 버튼을 선택해 포맷을 실행하거나 Cancel을 선택해 포맷을 중단하세요.
- 5 포맷 진행 과정을 보여주는 진행 표시줄이 나타납니다. 포맷이 완료되면 OK를 누르세요.
- 6 제어 패널에 있는 MENU 버튼을 누르면 시작 화면으로 되돌아 갑니다.

사용 준비가 완료되었습니다. 비디오와 오디오를 연결하고 SD 카드를 포맷하면 녹화를 시작할 수 있습니다!

정보 SD 카드의 다양한 종류와 크기에 따라 속도 또한 다양하므로 일부 카드의 포맷 속도가 더 빠를 수 있습니다.

녹화

제어 패널에 있는 녹화 버튼을 누르면 바로 녹화가 시작됩니다. 하지만 녹화에 사용할 유형을 결정하는 녹화 모드, 코덱, 비트 전송률과 같은 설정 사항 및 녹화 길이와 화질을 먼저 설정할 것을 권장합니다.

녹화 모드 설정하기

Blackmagic Duplicator 4K는 다음과 같은 녹화 모드를 제공합니다.

- **Duplicate:** 모든 SD 카드에 동시에 녹화됩니다.
- **Single Disk:** 한 번에 한 개의 SD 카드에 순서대로 녹화되며 카드가 가득 차면 녹화가 멈춥니다.
- **Single Disk Overwrite:** 한 번에 한 개의 SD 카드에 순서대로 녹화되며 연속해서 덮어쓰기 됩니다.

듀플리케이트(Duplicate) 모드

듀플리케이트 모드에서는 Blackmagic Duplicator 4K의 모든 SD 카드에 동일한 영상이 동시에 녹화됩니다.

싱글 디스크(Single Disk) 모드

Blackmagic Duplicator 4K는 TV 방송국부터 방범 카메라까지 다양한 환경에 사용할 수 있는 이상적인 로깅 레코더입니다. 한 번에 한 개의 SD 카드에 녹화하고 SD 카드가 가득 차면 다음 슬롯으로 녹화가 이어집니다. Blackmagic Duplicator 4K가 싱글 디스크 모드일 경우 SD 카드가 모두 차면 녹화가 중단됩니다. 25개의 녹화 슬롯이 있어 1주일 정도 되는 분량을 쉽게 녹화할 수 있습니다. 언제든지 카드를 새것으로 교체하기만 하면 끊기지 않고 연속적으로 녹화를 진행할 수 있습니다.

여러 대의 듀플리케이터를 함께 사용하는 경우 훨씬 장시간 녹화를 진행할 수 있습니다. 마스터 기기의 모든 카드가 가득 차면 첫 번째로 연결된 슬레이브 기기로 녹화가 이어집니다. 마지막 기기에 있는 카드가 모두 차면 녹화가 중단됩니다.

싱글 디스크 오버라이트(Single Disk Overwrite) 모드

싱글 디스크 오버라이트 모드는 한 대의 Blackmagic Duplicator 4K에서 두 개 이상의 SD 카드를 사용하여 녹화할 때 마지막 카드가 가득 차면 루프 모드로 다시 첫 번째 카드에 녹화가 진행되도록 하여 연속 녹화를 하는 방식입니다. 한 번에 한 개의 SD 카드 슬롯에 녹화가 진행됩니다. 한 개의 SD 카드가 가득 차면 다음 슬롯에 있는 카드가 포맷되며 녹화가 진행됩니다.

이 모드는 카드가 가득 찼을 때 녹화를 멈추는 것이 아니라 다음 카드를 포맷하고 녹화하는 기능이 루프 모드로 진행되는 것 말고는 싱글 디스크 모드와 비슷합니다. 싱글 디스크 오버라이트 모드로는 Blackmagic Duplicator 4K를 사용할 경우 녹화를 중단하기 전까지는 녹화가 멈추지 않고 계속해서 진행됩니다.

정보 싱글 디스크 모드 또는 싱글 디스크 오버라이트 모드로 촬영할 경우 언제든지 새로운 SD 카드를 삽입하여 녹화를 이어갈 수 있습니다. 25개의 슬롯 중 녹화 공간이 있는 카드가 장착되어 있는 한 Duplicator 4K는 녹화를 계속해서 진행합니다.

녹화 모드 설정하기

- 1 Blackmagic Duplicator 4K의 전원을 켜세요.
- 2 전면 제어 패널의 MENU 버튼을 누르면 LCD 메뉴가 나타납니다. 화면 옆에 있는 소프트 버튼에 불이 들어오면서 메뉴 옵션이 나타납니다. 녹화 소프트 버튼을 누르세요.
녹화 메뉴에서 화면 아래 나타나는 점들은 사용 가능한 옵션을 나타냅니다. Back 버튼을 누르면 언제든지 이전 메뉴로 되돌아갈 수 있습니다. </> 버튼을 사용하여 메뉴 옵션을 이동하세요.
- 3 MODE 옵션으로 이동한 다음 Change를 클릭합니다.
- 4 Select 버튼을 눌러 선택을 확인하세요. LCD 메뉴에 선택한 옵션이 나타납니다.
- 5 Back 버튼을 누르면 녹화 메뉴 화면으로 되돌아갑니다. 이제 선택한 옵션이 화면에 나타납니다.

여러 대의 듀플리케이터를 서로 데이지 체이닝 방식으로 연결하는 방법은 [데이지 체이닝] 및 [여러 대의 Blackmagic Duplicator 4K 데이지 체이닝으로 연결하기] 부분을 참고하세요.

정보 싱글 디스크 모드 또는 싱글 디스크 오버라이트 모드로 중요한 행사 장면을 녹화하는 상황에서 현재 사용 중인 SD 카드가 가득 차기 전에 카드를 제거하려면, 녹화 버튼을 3초간 길게 눌러 다음 SD 카드로 녹화가 전환되게 합니다. 듀플리케이트 모드로 녹화할 시에는 합치기 녹화 버튼을 누릅니다. 자세한 정보는 본 설명서의 [합치기 녹화] 부분을 참고하세요.

코덱 설정하기

Blackmagic Duplicator 4K에서는 파일 녹화 시 H.264와 H.265 압축 코덱을 사용하며 H.264 압축 방식을 사용하도록 기본 설정되어 있습니다.

코덱 변경하기

- 1 MENU 버튼을 누르세요.
- 2 2. Record에 해당하는 소프트 버튼을 선택해 녹화 설정으로 들어가세요.
- 3 3. 화살표 버튼을 사용하여 Codec 설정으로 이동한 다음 Change를 누르세요.
- 4 4. 화살표 소프트 버튼으로 원하는 코덱을 선택한 뒤, SET을 눌러 변경 사항을 저장하거나 제어 패널에 있는 MENU 버튼을 눌러 변경 사항을 저장하고 LCD 시작 화면으로 되돌아갑니다.

참고 Blackmagic Duplicator 4K는 소프트웨어 버전 1.1 혹은 그 이후 버전으로 반드시 업데이트해야 합니다. 소프트웨어 업데이트에 대한 자세한 정보는 [Blackmagic Camera Utility] 부분을 참고하세요.

올바른 코덱 선택하기

가장 높은 호환성을 제공하는 H.264 코덱 사용을 권장합니다. Blackmagic Duplicator 4K의 기본 코덱이 H.264로 설정되어 있는 이유가 바로 여기에 있습니다.

H.265 또한 비슷한 파일 크기의 높은 UHD 영상에 훌륭한 코덱이지만, 아직 출시된 지 얼마 되지 않았기 때문에 호환 가능한 컴퓨터 및 재생 장비가 제한적일 수 있습니다.

두 가지 코덱 모두 각각의 장점을 가지고 있습니다. H.265를 사용하면 주어진 영상 화질에 비해 비트 전송률과 파일 크기가 낮기 때문에 더욱 저렴한 SD 저장 장치를 사용할 수 있습니다. 작업하는 프로젝트에서 호환성이 중요할 경우 H.264를 선택하는 것이 좋습니다.

비트 전송률 설정하기

Blackmagic Duplicator 4K에서는 비트 전송률을 낮음(Low), 중간(Medium), 높음(High) 총 3단계로 설정할 수 있습니다. 이를 통해 내장된 비디오 인코더에서 초당 얼마나 많은 양의 비디오 데이터를 기록할지 선택할 수 있습니다. 비트 전송률 기본 설정은 좋은 화질의 녹화와 적당한 파일 크기를 위한 중간(Medium)으로 되어 있습니다. 하지만 이 설정은 LCD 메뉴에서 쉽게 변경할 수 있습니다.

비트 전송률 설정 변경하기

- 1 MENU 버튼을 누르세요.
- 2 Record에 해당하는 소프트 버튼을 선택해 녹화 설정으로 들어가세요.
- 3 소프트 버튼으로 화살표를 눌러 Bit Rate로 이동한 뒤, Change를 선택하세요.
- 4 화살표 소프트 버튼을 눌러 원하는 비트 전송률을 선택한 뒤, Set을 눌러 변경 사항을 저장하거나 제어 패널에 있는 MENU 버튼을 누르면 변경 사항을 저장되고 LCD 시작 화면으로 되돌아 갑니다.

참고 비트 전송률이 높을수록 녹화 영상의 화질이 높아지지만, 카드 용량이 빨리 차기 때문에 용량이 더욱 크고 비싼 카드가 필요합니다. 데이터 전송률을 낮추면 카드에 녹화할 수 있는 용량은 늘어나지만 영상 화질이 기대한 것보다 낮을 수 있습니다.

여러 가지 비트 전송률 설정으로 녹화 해본 뒤, 가장 적절한 영상 화질과 파일 크기를 가진 비트 전송률을 선택하는 것이 좋습니다.

클립 녹화하기

제어 패널에 있는 녹화 버튼을 누르면 녹화가 시작됩니다. 녹화 중에는 각 슬롯에 있는 LED 상태 표시등에 빨간 불이 들어옵니다. 녹화가 중단되면 LED 표시등에 녹화가 성공적으로 완료되었으며 다른 클립의 녹화 준비가 완료되었음을 나타내는 녹색불이 들어옵니다. SD 카드 슬롯이나 리더기를 통해 컴퓨터에서 또는 SD 카드 및 exFAT 파일 시스템을 지원하는 HDMI TV에서 녹화된 결과물을 확인할 수 있습니다.

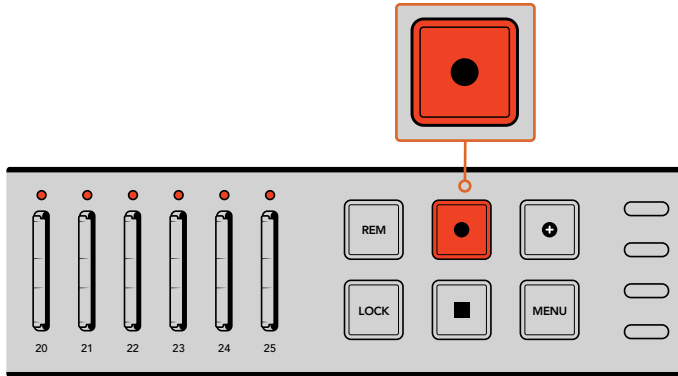





녹화 버튼을 누르면 녹화가 시작됩니다. 각 슬롯 위에 있는 상태 표시 LED에 빨간 불이 들어와 SD 카드에 녹화가 진행 중임을 나타냅니다.

LED 상태 표시등

각 SD 카드 슬롯 위에 위치한 LED 상태 표시등에는 슬롯의 상태를 나타내는 다양한 색상의 불빛이 들어옵니다. 예를 들어, SD 카드를 삽입한 뒤, 슬롯 위에 있는 LED에 녹색 불이 들어오면 카드가 인식되고 녹화 준비가 완료되었음을 나타냅니다.

다음은 LED 색상과 움직임, 그리고 그에 따른 상태에 대한 설명입니다.

- 
녹색 유지
 촬영 준비가 완료된 경우. LED에 녹색불이 들어오면 SD 카드에 녹화 준비가 완료되었음을 나타냅니다.
- 
빨간색 유지
 녹화 중. 클립이 녹화되는 동안 LED에 빨간 불이 들어옵니다.
- 
깜빡이는 빨간불
 녹화 중인 카드의 용량이 거의 다 찬 경우. 노란 불이 깜빡일 경우, 이는 카드에 녹화할 수 있는 시간이 3분 미만이라는 것을 뜻합니다.
- 
빠르게 깜빡이는 빨간불
 드롭 프레임 현상이 발생한 경우. SD 카드의 쓰기 속도와 녹화 속도가 일치하지 않을 때 발생합니다.
- 
노란색 유지
 카드가 가득 찼거나 쓰기 금지 및 쓰기 실패. 녹화 도중 노란색 LED 불빛이 지속되면 SD 카드에 문제가 있거나, 쓰기 방지가 되어 있거나, 포맷이 되지 않았거나, 녹화 공간이 10초도 남지 않았다는 것을 뜻합니다. 잠금 스위치를 Unlock 방향으로 밀거나, 데이터 속도를 낮추거나, 빠른 속도를 가진 SD 카드를 사용하거나, 카드를 포맷하거나, 다른 카드로 교체하는 시도를 해보세요.

비록 녹화 중에 카드가 제거되는 경우에 대비해 복사기에서 각 카드의 파일 시스템을 정돈하고 준비해 두기는 하지만, Blackmagic Duplicator 4K에서 녹화가 진행 중일 때는 SD 카드를 제거하지 않는 것이 좋습니다. 이는 카드를 확인하는 데 사용되는 일부 운영 체제가 다른 운영 체제보다 견고하지 못해 녹화물이 손상되는 일이 발생할 수도 있기 때문입니다. 따라서 카드를 제거하기 전에 녹화를 중단하는 것이 안전합니다. 공연이 끝나기 전에 일부 사람들에게 카드를 먼저 전달하고자 할 경우, 여러 대의 복사기를 사용해 녹화하다가 그 중 하나의 유닛에서 녹화를 정지해 카드를 전달하고 나머지 유닛에서는 녹화를 계속 진행하는 것도 좋은 방법 중 하나입니다.

정보 SD 카드 클래스 10은 Blackmagic Duplicator 4K에서 지원하는 모든 데이터 전송률로 녹화할 수 있으며, 필요할 경우 낮은 전송률을 지원하는 카드를 사용해 낮은 데이터 전송률로 녹화할 수도 있습니다. 예를 들면, 보안용의 장시간 녹화가 필요한 경우에는 높은 비디오 화질이 필요하지 않습니다. 항상 테스트 녹화를 실행하여 사용하는 SD 카드가 선택한 비트 전송률의 비디오를 녹화할 수 있는지 확인해 볼 것을 권장합니다. SD 카드 속도와 관련한 자세한 정보는 시작하기 부분의 [SD 카드 삽입 및 포맷하기]를 참고하세요.

합치기 녹화

듀플리케이트 모드로 녹화하면 기존에 녹화된 클립에 이어 새로운 클립이 녹화되어 하나의 클립으로 생성됩니다. 예를 들면, 여러 개의 이벤트로 구성된 하나의 행사를 녹화하는 경우가 여기에 해당됩니다. 각기 다른 이벤트 녹화 영상을 하나의 클립으로 녹화할 수 있는 기능이 바로 합치기 녹화 기능입니다.

- 1 녹화 버튼을 사용하는 일반적인 방법으로 첫 번째 클립을 녹화하세요. 정지 버튼을 누르세요.
- 2 다음 행사가 시작되면 합치기 녹화 버튼을 누르세요. 일반 녹화 버튼과 함께 합치기 버튼에 불이 들어와 기존에 녹화된 클립에 이어 새로운 클립이 녹화된다는 것을 나타냅니다.
- 3 정지 버튼을 누르세요. 새로운 클립이 첫 번째 클립에 이어 녹화되어 하나의 클립으로 저장됩니다.

정보 합치기 녹화 기능 사용 시, 첫 번째 클립에 합칠 수 있는 시퀀트 클립의 수는 제한이 없습니다. 카드 용량 크기와 녹화 길이만 고려하면 됩니다.

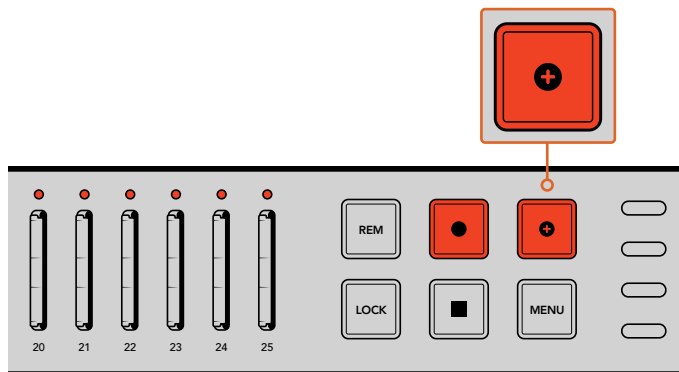

합치기 버튼을 누르면 새로운 클립이 기존에 녹화된 클립에 이어 녹화됩니다.

정보 싱글 디스크 또는 싱글 디스크 오버라이트 모드를 사용할 경우 녹화 버튼을 3초간 길게 누르면 사용 중이던 카드에서 다음 카드로 녹화가 넘어갑니다. 녹화를 중단하지 않고 중요한 행사 녹화로 바로 이동할 시에 사용하기 유용한 기능입니다. 싱글 디스크 모드 및 싱글 디스크 오버라이트 모드에 관한 자세한 정보는 [녹화 모드 설정하기] 부분을 참고하세요. 듀플리케이트 모드로 녹화할 시에는 합치기 녹화 버튼을 누릅니다. 더욱 자세한 정보는 [합치기 녹화] 부분을 참고하세요.

Blackmagic Duplicator 4K 잠금 기능

중요한 이벤트를 녹화하는 경우, 제어 패널 잠금 기능을 사용해 실수로 녹화를 중단시키는 일을 방지할 수 있습니다. 또한 데이지 체이닝으로 연결된 모든 슬레이브 디바이스를 잠그는 데 유용하게 사용할 수 있어 특정 유닛 컨트롤에서 녹화를 방해할 일이 전혀 발생하지 않습니다.

각 기기에 있는 LOCK 버튼으로 잠금 기능을 기기마다 활성화 또는 비활성화할 수 있습니다. 각 기기에서 제어 잠금 기능을 해제하려면 LOCK 버튼을 2초간 길게 눌러야 하기 때문에 실수로 기기의 잠금 기능이 해제될 일은 거의 없습니다.

Blackmagic Duplicator 4K에 잠금 기능 사용하기

- 1 Blackmagic Duplicator 4K의 제어 패널에서 LOCK 버튼을 누르세요.
- 2 기기의 잠금 기능을 해제하려면 LOCK 버튼을 길게 누르세요. 2초가 지나면 기기의 잠금 기능이 해제됩니다.

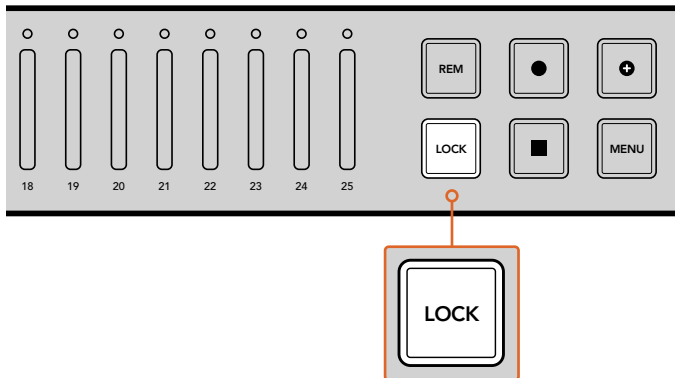

LoBlackmagic Duplicator 4K의 제어 패널 잠금 기능을 사용해 실수로 녹화가 중단되는 일을 막을 수 있습니다.

여러 대의 Duplicators 데이지 체이닝으로 연결하기

여러 대의 Blackmagic Duplicator 4K를 데이지 체이닝으로 연결해 25개 이상의 SD 카드에 녹화를 진행할 수 있습니다. 데이지 체이닝으로 연결하면 각 기기의 루프 SDI 커넥터를 통해 동일한 비디오 신호를 공유할 수 있을 뿐만 아니라 RS-422 프로토콜을 사용해 리모트 커넥터로 서로 통신할 수 있습니다.

여러 대의 Blackmagic Duplicator 4K 데이터 체이닝으로 연결하기

- 1 DB-9 커넥터가 달린 일반 시리얼 케이블을 사용해 첫 번째 기기의 RS-422 REMOTE OUT 포트와 두 번째 유닛의 REMOTE IN 포트를 연결하세요. DB-9 커넥터가 달린 시리얼 케이블은 인근 컴퓨터 및 비디오 장비 판매점에서 쉽게 구할 수 있습니다.
- 2 첫 번째 기기의 루프 SDI 출력을 두 번째 유닛의 SDI 입력에 연결하세요.

사용법이 얼마나 간단한지 확인하실 수 있습니다. 각 기기의 리모트 출력과 루프 출력을 다음 기기의 리모트 입력과 SDI 입력에 연결하는 과정을 마지막 기기에 연결할 때까지 반복해 더 많은 Blackmagic Duplicator 4K를 데이터 체이닝으로 연결할 수 있습니다.

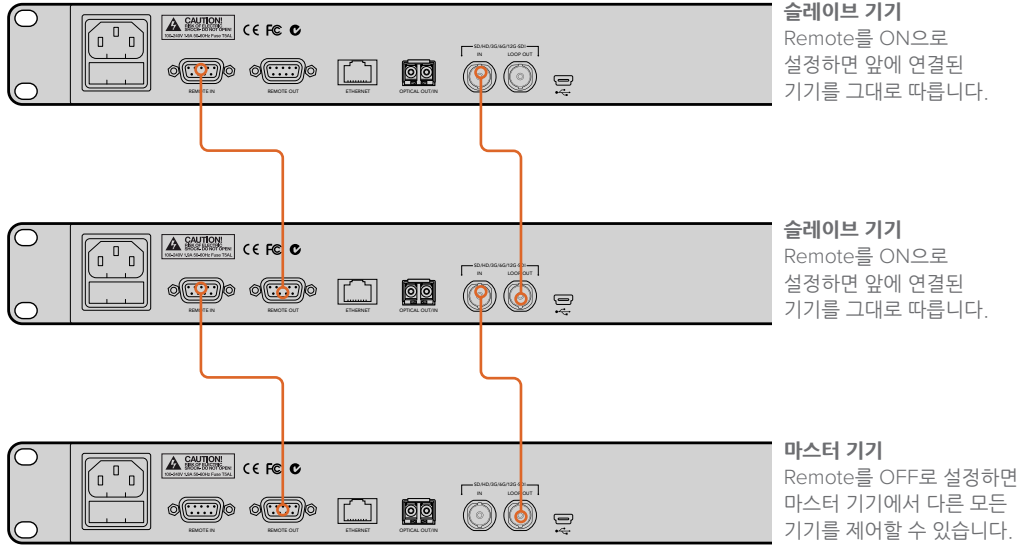

한 기기의 루프 출력을 다음 기기의 SDI 입력에 연결하여 여러 대의 Blackmagic Duplicator 4K를 데이터 체이닝으로 간단히 연결할 수 있습니다. 마찬가지로, 한 기기의 리모트 출력을 다음 기기의 리모트 입력에 연결하세요.

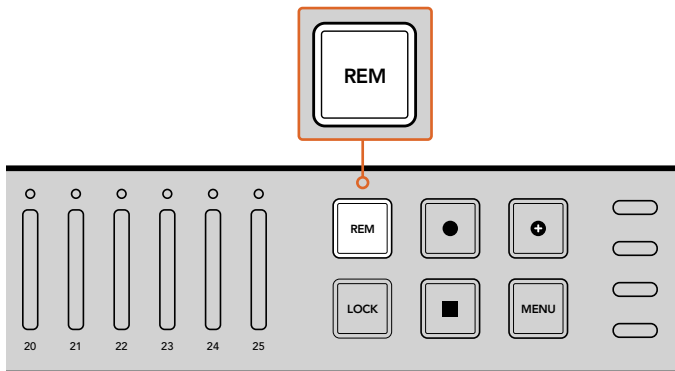

데이터 체이닝으로 연결된 각 슬레이브 기기의 REMOTE 버튼을 누르면 첫 번째 기기에서 원격으로 제어할 수 있습니다.

참고 각 슬레이브 기기 제어 패널의 Remote 버튼이 선택되어 있는지 확인하세요. 선택된 Remote 버튼에는 불이 들어옵니다. 버튼을 다시 누르면 기능이 해됩니다.

최종 녹화를 진행하기 전에 테스트 녹화 과정을 거쳐 마스터 기기로 다른 기기를 제어할 수 있는지 확인하세요. 슬레이브 기기를 마스터 기기로 제어할 수 없는 경우에는 마스터 기기의 REMOTE 버튼이 꺼져 있는지, 또 슬레이브 기기의 REMOTE 버튼이 켜져 있는지 확인하세요.

LCD 메뉴 설정

제어 패널의 LCD 메뉴와 소프트 버튼을 사용하여 Blackmagic Duplicator 4K의 모든 설정을 변경할 수 있습니다. LCD 양 옆에 위치한 소프트 버튼은 LCD 메뉴에 나타나는 설정에 맞게 불이 들어옵니다.

설정 변경하기

- 1 제어 패널의 MENU 버튼을 누르면 LCD 메뉴 설정이 나타납니다.
- 2 소프트 버튼을 사용해 원하는 메뉴로 이동합니다.
- 3 설정을 선택하면 Change에 해당하는 소프트 버튼을 누릅니다.
- 4 설정을 조절한 뒤, Set 버튼을 눌러 변경 사항을 저장합니다.

Back 메뉴의 소프트 버튼을 누르면 한 단계 전 메뉴로 되돌아가므로 언제든지 변경을 취소할 수 있습니다. 제어 패널의 MENU 버튼을 누르면 LCD 시작 화면으로 간단히 되돌아갈 수 있습니다.

녹화(Record)

Record 설정에서는 비디오 소스를 변경하고, 비트 전송률을 설정할 수 있으며, 트리거 녹화 기능을 활성화/비활성화시키거나 SD 카드 포맷을 실행할 수 있습니다.

비디오 소스(Video source)

Optical Fiber SDI 모듈을 설치한 경우 SDI 입력과 광섬유 입력 중에서 원하는 것을 선택할 수 있습니다.

모드(Mode)

다음과 같은 설정을 사용하여 녹화 모드를 선택하세요.

듀플리케이트(Duplicate)

모든 SD 카드에 같은 영상을 동시에 녹화합니다.

싱글 디스크

한 번에 한 개의 SD 카드에 녹화하고 SD 카드가 가득 차면 다음 SD 카드로 녹화가 이어집니다. 모든 카드가 가득 차면 Duplicator 4K에서 녹화가 중단됩니다. 여러 대의 기기를 데이지 체이닝 방식으로 연결한 경우 SD 카드가 모두 차면 다음 Duplicator 4K 기기에서 녹화가 이어집니다.

싱글 디스크 오버라이트(Single Disk Overwrite)

무한대 연속 녹화가 가능합니다. 한 번에 한 개의 SD 카드에 녹화하고 SD 카드가 가득 차면 다음 SD 카드로 녹화가 이어집니다. 모든 카드가 가득 차면 Duplicator 4K는 첫 번째 SD 카드로 넘어가 녹화가 계속 진행됩니다.

코덱

코덱 설정에서 H.264와 H.265 중 Blackmagic Duplicator 4K 녹화에 사용할 압축 코덱을 선택하세요.

아래는 두 가지 종류의 코덱에 대한 설명입니다.

H.264

가장 흔히 사용하는 압축 형식으로 균형 잡힌 영상 화질과 파일 크기를 제공합니다. 이 코덱을 사용해 압축된 파일의 경우, 적어도 HD 해상도까지는 지난 10년 이내에 제작된 대부분의 재생 장비를 사용해 볼 수 있습니다.

H.265

주어진 영상 화질을 위해 비디오 파일 크기를 반으로 줄여주는 성능을 가진 고성능 압축 방식입니다. 이 코덱은 고화질 또는 UHD 영상 패키지 사용에 좋은 코덱이지만, 영상을 시청하기 위해서는 최신 버전의 재생 소프트웨어 하드웨어가 필요할 수도 있습니다.

참고 H.264와 H.265의 차이에 대한 더욱 자세한 정보는 본 설명서 [녹화] 부분에서 확인하실 수 있습니다.

비트 전송률(Bit Rate)

비트 전송률 설정은 SD 카드에 수록할 수 있는 비디오 용량과 영상 화질을 결정합니다. 다음과 같은 세 가지 옵션에서 선택할 수 있습니다.

High

가장 낮은 압축률과 가장 높은 화질의 비디오를 녹화하려면 High를 선택합니다.

Medium

SD 카드에 더욱 많은 용량의 비디오를 좋은 화질로 저장하려면 Medium 설정을 사용하세요.

Low

높은 비디오 화질은 필요하지 않고 최대 용량의 비디오 저장 공간이 필요한 경우에는 Low를 선택합니다. 이 설정은 가장 높은 압축률을 사용하므로 고압축으로 인한 아티팩트가 나타날 수 있습니다.

참고 내장 H.265 인코더는 최신 압축 기술을 사용하므로 가장 낮은 데이터 용량으로 가장 높은 화질의 비디오를 녹화할 수 있습니다. 가장 높은 비디오 압축률의 가장 낮은 비디오 화질 설정에도 훌륭한 화질의 영상을 녹화할 수 있습니다.

비디오 포맷에 따른 비트 전송률

Ultra HD			
비디오 포맷	비트 전송률 설정	비트 전송률 (Mb/s) H.264	비트 전송률 (Mb/s) H.265
2160p60	높음	75	50
	중간	66	38
	낮음	50	20
2160p59.94	높음	75	50
	중간	66	38
	낮음	50	20

Ultra HD			
비디오 포맷	비트 전송률 설정	비트 전송률 (Mb/s) H.264	비트 전송률 (Mb/s) H.265
2160p50	높음	72	48
	중간	61	32
	낮음	42	16
2160p30	높음	50	30
	중간	37	20
	낮음	24	10
2160p29.97	높음	50	30
	중간	37	20
	낮음	24	10
2160p25	높음	40	25
	중간	32	18
	낮음	20	10
2160p24	높음	40	25
	중간	32	18
	낮음	20	10
2160p23.98	높음	40	25
	중간	32	18
	낮음	20	10

HD			
비디오 포맷	비트 전송률 설정	비트 전송률 (Mb/s) H.264	비트 전송률 (Mb/s) H.265
1080p60	높음	40	20
	중간	32	15
	낮음	20	10
1080i60	높음	40	20
	중간	32	15
	낮음	20	10
1080p59.94	높음	40	20
	중간	32	15
	낮음	20	10
1080i59.94	높음	40	20
	중간	32	15
	낮음	20	10
1080p50	높음	36	20
	중간	28	15
	낮음	18	10

HD			
비디오 포맷	비트 전송률 설정	비트 전송률 (Mb/s) H.264	비트 전송률 (Mb/s) H.265
1080i50	높음	36	20
	중간	28	15
	낮음	18	10
1080p30	높음	28	15
	중간	20	11
	낮음	11	7
1080p29.97	높음	28	15
	중간	20	11
	낮음	11	7
1080p25	높음	24	15
	중간	16	10
	낮음	9	6
1080p24	높음	24	15
	중간	15	10
	낮음	8	6
1080p23.98	높음	24	15
	중간	15	10
	낮음	8	6
720p60	높음	25	12
	중간	17	10
	낮음	9	8
720p59.94	높음	25	12
	중간	17	10
	낮음	9	8
720p50	높음	20	12
	중간	14	9
	낮음	7	6

SD			
비디오 포맷	비트 전송률 설정	비트 전송률 (Mb/s) H.264	비트 전송률 (Mb/s) H.265
625i50 PAL	높음	18	11
	중간	12	8
	낮음	6	6
525i59.94 NTSC	높음	20	12
	중간	14	9
	낮음	7	6

트리거(Trigger)

트리거 설정에서는 Blackmagic URSA Mini와 같은 다른 SDI 장비의 녹화 버튼으로 Blackmagic Duplicator 4K에서 녹화를 진행시킬 수 있는 녹화 트리거 기능을 활성화 할 수 있습니다.

None

트리거 녹화 기능의 사용을 중지하려면 None을 선택합니다.

SDI Start/Stop

SDI Start/Stop을 선택하면 다른 SDI 장비의 녹화 버튼을 누를 시, Blackmagic Duplicator 4K에서 녹화가 시작됩니다.

예를 들어, Blackmagic URSA Mini는 SDI 출력을 통해 항상 녹화 트리거 신호를 전송하기 때문에 카메라의 녹화 버튼을 누를 때마다 Blackmagic Duplicator 4K에서 녹화가 시작되며, 녹화 버튼을 다시 한 번 누르면 녹화가 중지됩니다. URSA Mini에서 트리거 녹화 기능을 사용하기 위해 어떤 설정 변경도 필요하지 않지만, 트리거 녹화 기능을 지원하는 다른 SDI 장비에서 이 기능을 사용하려면 해당 장비의 설정 메뉴에서 SDI Start/Stop 트리거 녹화 기능을 활성화해야 합니다.

Timecode Run

SDI 장비가 SDI Start/Stop 트리거 녹화 기능을 지원하지 않을 경우, Blackmagic Duplicator 4K가 타임코드를 감지하자마자 녹화를 시작하도록 설정할 수 있습니다. 예를 들면, Blackmagic Duplicator 4K에 SDI 카메라가 연결되어 있는 상태에서 카메라의 Record Run 타임코드 기능을 설정한 경우, Blackmagic Duplicator 4K에서도 녹화가 시작됩니다. 카메라의 녹화를 중지하면 타임코드 또한 멈추고 Blackmagic Duplicator 4K의 녹화 또한 중지됩니다.

굉장히 편리한 기능이지만, 사용하는 장비의 타임코드 설정이 Record Run으로 되어 있는지를 확인해야 합니다. 타임코드 설정이 Time of Day로 설정된 경우, 진행 중인 타임코드가 계속해서 출력되고, Blackmagic Duplicator 4K에서 원치 않는 녹화가 시작됩니다.

카드 포맷하기

Blackmagic Duplicator 4K에서 포맷 기능을 사용하여 최대 25개의 카드를 동시에 포맷할 수 있습니다.

카드 포맷하기

- 1 제어 패널의 MENU 버튼을 누르면 LCD 메뉴가 나타납니다.
- 2 Record 메뉴의 소프트 버튼을 사용하여 녹화 설정을 엽니다.
- 3 왼쪽 또는 오른쪽 화살표에 해당하는 소프트 버튼을 눌러 Format Card 설정으로 이동한 뒤, Format을 누릅니다.
- 4 포맷 확인을 묻는 메시지가 나타납니다. 실행을 취소할 수 없다는 경고 메시지가 나타납니다. SD 카드에 중요한 데이터가 저장되어 있을 경우, 포맷을 실행하기 전에 반드시 백업해두시기 바랍니다.
- 5 포맷을 진행하려면 Format 버튼을 누릅니다. Cancel을 누르면 Record 설정 이전 화면으로 되돌아갑니다.
- 6 카드가 포맷되는 동안 상태 LED 상태 표시등에 노란불이 깜빡이며 LCD에는 진행 표시줄이 나타납니다. 카드 포맷이 완료되면 상태 표시등에 초록불이 들어오며 LCD 메뉴에는 카드 포맷과 녹화 준비가 완료되었다는 표시가 나타납니다.
- 7 OK를 누르세요. 제어 패널의 MENU 버튼을 누르면 시작 화면으로 되돌아갑니다.

설정(Settings)

Settings 메뉴에서는 DHCP와 IP 주소, 서브넷 마스크, 게이트웨이 같은 Blackmagic Duplicator 4K를 위한 네트워크 설정을 변경할 수 있습니다. Blackmagic Duplicator 4K를 네트워크에 연결하면 Telnet과 같은 서드 파티 관리 소프트웨어를 통한 원격 제어가 가능합니다.

DHCP 'ON'

Blackmagic Duplicator 4K가 네트워크에 연결되었을 때 자동으로 가장 적합한 설정을 사용하도록 하려면 ON을 선택합니다. 다시 말해, Blackmagic Duplicator 4K에서 네트워크에 연결된 모든 장치를 확인하고 설정 충돌이 일어나지 않도록 IP 주소와 다른 네트워크를 설정합니다. 가장 빠르고 안전하게 네트워크 설정을 실행할 수 있는 방법입니다.

DHCP 'OFF'

네트워크 설정 전체를 수동으로 제어하려면 DHCP를 OFF로 설정하고, IP 주소와 서브넷 마스크, 게이트웨이 설정을 변경합니다.

IP 주소, 서브넷 마스크, 게이트웨이

DHCP를 OFF로 설정하면 수동으로 설정을 변경할 수 있습니다.

필드 숫자 편집하기

- 1 좌/우 화살표에 해당하는 소프트 버튼을 사용하여 변경하려는 필드 숫자를 선택한 뒤 Change를 누릅니다.
- 2 좌/우 화살표에 해당하는 소프트 버튼을 눌러 설정값을 위/아래로 조절합니다. 소프트 버튼을 길게 누르면 더욱 빠르게 이동할 수 있습니다.
- 3 Set 버튼을 눌러 변경 사항을 저장합니다.

이제 소프트 메뉴 버튼을 사용하여 위 순서대로 필요한 설정 변경할 수 있습니다.



LCD의 Settings 메뉴에서 네트워크 설정을 변경하여 Telnet과 같은 서드 파티 관리 소프트웨어로 Blackmagic Duplicator 4K를 제어할 수 있습니다.

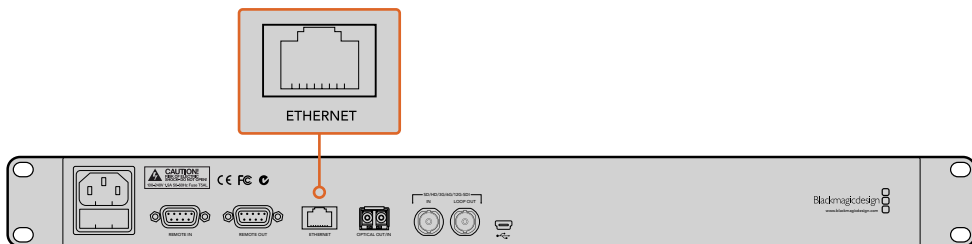

뒷면 패널의 이더넷 포트를 통해 Blackmagic Duplicator 4K를 사용자 네트워크에 연결합니다.

정보(About)

About 메뉴 설정에서는 현재 설정된 비트 전송률과 최신 녹화 파일명, 네트워크 상태, Blackmagic Duplicator 4K 내부 소프트웨어 버전을 한눈에 확인할 수 있습니다.

Blackmagic Duplicator Utility

Blackmagic Duplicator 4K 업데이트하기

Blackmagic Duplicator Utility 소프트웨어에서 Blackmagic Duplicator 4K의 내부 소프트웨어를 업데이트하고 File Name Prefix 설정을 변경하여 녹화 영상에 라벨을 사용할 수 있습니다. 소프트웨어를 다운로드하여 새로운 기능 및 개선된 기능을 Blackmagic Duplicator 4K에 업데이트할 것을 권장드립니다.

최신 버전의 소프트웨어는 Blackmagic 고객센터(www.blackmagicdesign.com/kr/support)에서 다운로드할 수 있습니다.

mac OS에서 내부 소프트웨어 업데이트하기

- 1 Blackmagic Duplicator Utility를 다운로드하여 압축을 풉니다.
- 2 작업이 완료된 디스크 이미지를 열고 Blackmagic Duplicator Utility 설치 프로그램을 실행합니다. 화면에 나타나는 지시 사항을 따르세요.
- 3 최신 Blackmagic Duplicator Utility 설치가 완료되면 Blackmagic Duplicator 4K의 USB 케이블을 컴퓨터에 연결합니다.
- 4 Blackmagic Duplicator Utility를 실행하고 설정 아이콘을 클릭하여 설정 페이지를 엽니다. Blackmagic Duplicator 4K에 이전 버전의 소프트웨어가 설치된 것이 발견되면 Update Now 아이콘이 나타납니다. 아이콘을 클릭하면 내부 소프트웨어 업데이트가 시작됩니다. Blackmagic Duplicator 4K에 최신 버전의 내부 소프트웨어가 설치된 경우에는 바로 사용을 시작할 수 있습니다.

Windows에서 내부 소프트웨어 업데이트하기

- 5 Blackmagic Duplicator Utility를 다운로드하여 압축을 풉니다.
- 6 본 설명서와 Blackmagic Duplicator Utility 설치 프로그램이 있는 Blackmagic Duplicator Utility 폴더를 볼 수 있습니다. 설치 프로그램을 더블 클릭한 뒤, 나타나는 지시 사항을 따르면 설치가 완료됩니다.
- 7 최신 Blackmagic Duplicator Utility 설치가 완료되면 Blackmagic Duplicator 4K의 USB 케이블을 컴퓨터에 연결합니다.
- 8 Blackmagic Duplicator Utility를 실행하고 설정 아이콘을 클릭하여 설정 페이지를 엽니다. Blackmagic Duplicator 4K에 이전 버전의 소프트웨어가 설치된 것이 발견되면 Update Now 아이콘이 나타납니다. 아이콘을 클릭하면 내부 소프트웨어 업데이트가 시작됩니다. Blackmagic Duplicator 4K에 최신 버전의 내부 소프트웨어가 설치된 경우에는 바로 사용을 시작할 수 있습니다.

파일명 접두사

파일명 접두사를 변경하여 녹화 영상에 라벨을 사용할 수 있으므로 파일을 쉽게 확인할 수 있습니다. File Name Prefix 입력란을 클릭하고 새로운 파일명을 입력하면 변경이 완료됩니다. 이제 Blackmagic

Duplicator 4K가 다음 클립 녹화를 시작하면 입력한 파일명과 그 뒤에 클립 번호를 확인할 수 있는 4 자리의 숫자로 파일명이 나타납니다. 이 4자리 숫자는 녹화 클립의 수에 따라 증가합니다.

데이터 체인으로 연결된 모든 기기에서 같은 파일명을 사용할 수 있도록 슬레이브 기기의 Remote 버튼을 켜 뒤, 마스터 기기의 파일명 접두사 설정을 변경합니다. 이렇게 설정하면 모든 기기의 녹화 클립과 카드에 같은 파일명이 저장됩니다.

Optical Fiber SDI Module 옵션 설치하기

광섬유를 통해 SDI 비디오를 연결하려면 Optical Fiber SDI Module 옵션을 설치해야 합니다. 모든 SMPTE 호환 SFP 광섬유 모듈을 설치할 수 있습니다. Blackmagic Design 리셀러로부터 모듈을 별도로 구매할 수 있습니다. Blackmagic Duplicator 4K 뒷면 패널의 내장 광섬유 케이지에 간단히 연결하여 사용할 수 있습니다. Optical Fiber SDI Module을 설치하면 굉장히 긴 케이블을 통해 오디오가 임베드된 SDI 비디오를 연결할 수 있습니다. 광섬유 출력을 추가 루프 비디오 커넥터로 사용할 수도 있습니다.

3G-SDI 및 6G-SDI 광섬유 같이 낮은 속도의 광섬유 시스템을 운영하여 높은 속도가 필요하지 않은 경우, 좀 더 느린 속도의 모듈을 슬롯에 장착하면 비용을 줄일 수 있습니다.

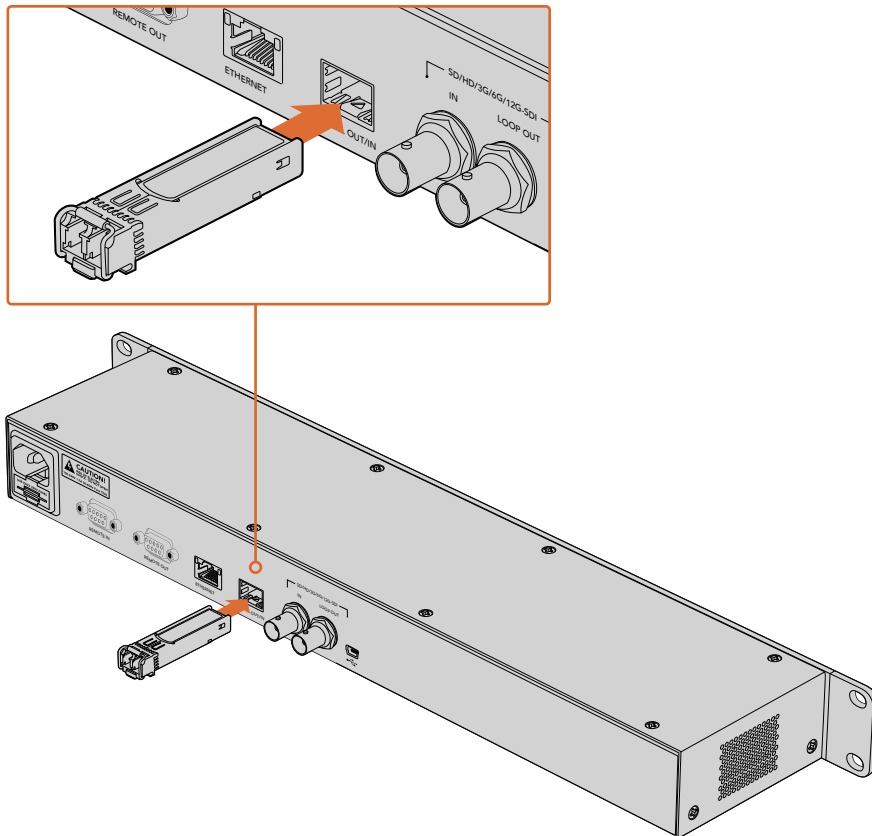

Optical Fiber SDI Module 옵션을 설치하면 광섬유를 통해 SDI 비디오를 연결할 수 있습니다.

Blackmagic Duplicator 4K는 어떤 종류의 비디오 커넥터든 먼저 연결된 커넥터를 사용하지만, SDI와 광섬유가 모두 연결된 경우에는 LCD 메뉴의 Video Source 설정에서 선택할 수 있습니다. 더 자세한 정보는 본 설명서의 [설정] 부분을 참고하세요.

RS-422 컨트롤

RS-422 컨트롤이란?

RS-422 표준은 1980년대 초반부터 방송국에서 사용해 온 방송 표준을 위한 시리얼 데크 컨트롤로 대부분의 데크 및 선형/비선형 편집 시스템, 방송 자동화 운영 장치에서 사용하고 있습니다. Blackmagic Duplicator 4K 또한 이 표준을 지원하므로 방송 자동화 시스템 및 원격 제어 시스템, 예약 녹화 시스템 등 원하는 모든 종류의 사용자 지정 컨트롤에 통합시킬 수 있습니다.

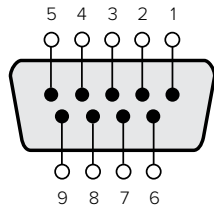

송신 (-)	송신 (+)	수신 (-)	수신 (+)	접지핀
2	7	8	3	1, 4, 6, 9

R원격 출력 커넥터를 위한 RS-422 원격 핀 연결.

외부 RS-422 컨트롤러 사용하기

Blackmagic Duplicator 4K는 Sony와 호환하는 업계 표준 Remote RS-422 데크 컨트롤 포트를 지원하므로 RS-422를 지원하는 모든 원격 컨트롤러에 바로 연결하여 사용할 수 있는 정확한 핀 연결을 지원합니다.

케이블 양쪽 끝에 같은 수의 핀이 연결된 커넥터가 달린 9핀 케이블을 사용할 수 있습니다. 사용하는 장비의 연결이 달라 커스텀 케이블을 제작하려는 경우, 제품과 함께 제공된 원격 출력 배선도를 참고하여 송신(Tx) 신호선을 수신(Rx) 신호선에 정확히 배선합니다.

외부 RS-422 컨트롤러를 Blackmagic Duplicator 4K에 연결하면 기기에서 직접 버튼을 누를 필요없이 원격으로 제어할 수 있습니다.

- 1 외부 컨트롤러의 RS-422 케이블을 Blackmagic Duplicator 4K 리모트 입력에 연결합니다.
- 2 Blackmagic Duplicator 4K의 제어 패널에서 REM이라고 표시된 원격 버튼을 눌러 원격 데크 제어 기능을 활성화합니다.

Blackmagic Duplicator 4K의 일반 녹화 또는 합치기 녹화 기능을 원격으로 시작/중지할 수 있습니다. 지원 RS-422 명령어에 관한 전체 목록은 다음 [지원 RS-422 명령어] 부분에서 확인할 수 있습니다.

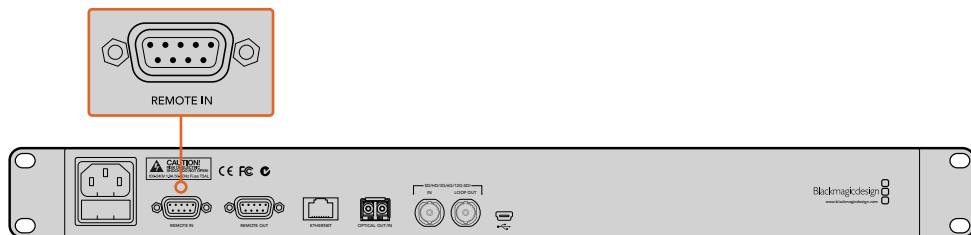

외부 RS-422 컨트롤러를 Blackmagic Duplicator 4K 리모트 입력에 연결하여 기기를 원격으로 제어합니다.

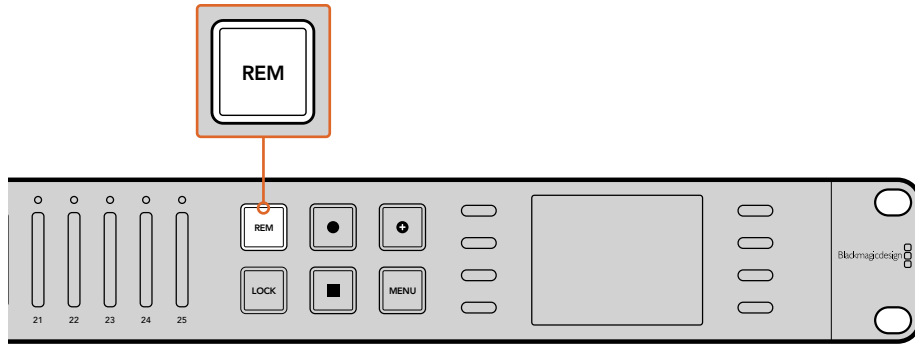

Blackmagic Duplicator 4K의 제어 패널에서 REM 버튼을 눌러 RS-422 데크 제어 기능을 활성화합니다.

Supported RS-422 Commands

		Command	Reply	No Remote	Notes
0 - System Control					
0x00	0x11	DeviceTypeRequest	NTSC: 0xF0E0 PAL: 0xF1E0 24P: 0xF2E0	Enabled	-
1 - Slave Response					
0x20	0x00	Stop	Acknowledge	Disabled	-
0x20	0x02	Record	Acknowledge	Disabled	-
0x21	0x02	Append	Acknowledge	Disabled	Non-standard command - an extra payload of 0x00 indicates append
4 - Preset/Select Control					
0x40	0x40	AutoMode Off	Acknowledge	Disabled	ignored, Status bit remembered
0x40	0x41	AutoMode On	Acknowledge	Disabled	ignored, Status bit remembered
0x61	0x20	StatusSense	StatusData	Enabled	-
7 - Sense Reply					
0x70	0x20	StatusData	-	-	Please see "Status Bits" sheet: Limited to 9 bytes of status, silently truncated

RS-422 Developer Information

	Bit 7	Bit 6	Bit 5	Bit 4	Bit 3	Bit 2	Bit 1	Bit 0
Byte 0	0	0	Cassette out	0	0	0	0	Local
Byte 1	Standby	0	Stop	0	0	0	Record	0
Byte 2	0	0	0	0	0	0	0	0
Byte 3	Auto Mode	0	0	0	0	0	0	0
Byte 4	Select EE	Full EE	0	0	0	0	0	0
Byte 5	0	0	0	0	0	0	0	0
Byte 6	0	0	0	0	0	0	0	0
Byte 7	0	0	0	0	0	0	0	0
Byte 8	0	0	0	0	0	0	0	0
Byte 9	0	0	0	0	0	0	0	0

Variables	
Cassette Out	Set if no cards are ready to record
Local	Set if in local mode (no remote control)
Standby	Set if one or more cards are ready to record
Auto Mode	For compatibility only
Full EE	For compatibility only - always on
Select EE	For compatibility only - always on

Blackmagic Duplicator 4K RS-422 Settings	
Protocol	Based on Sony 9-pin protocol
Baud Rate	38.4 K
Start Bits	1
Data Bits	8
Stop Bits	1
Parity Bits	1
Parity Type	Odd

이더넷을 통한 원격 제어

Blackmagic HyperDeck 이더넷 프로토콜의 텍스트 기반 명령어를 사용하는 이더넷을 통해 Blackmagic Duplicator 4K를 외부에서 제어할 수 있습니다. 이 명령어는 컴퓨터에서 Telnet과 같은 관리 소프트웨어를 통해 Blackmagic Duplicator 4K를 원격으로 제어하거나, 사용자가 직접 하드웨어 제어 패널을 제작하여 HyperDeck 이더넷 프로토콜을 사용해 Blackmagic Duplicator 4K에 통합하도록 프로그래밍할 수 있게 해줍니다.

컴퓨터 및 전용 하드웨어 제어 장치 또는 방송 스튜디오나 방송 차량에서 사용하는 대규모 시스템에서 듀플리케이터를 제어할 수 있는 커스텀 솔루션을 사용자가 직접 제작할 수 있습니다. 예를 들어, 실드라고 부르는 확장 보드를 사용하여 소형 회로판인 아두이노 마이크로컨트롤러를 제작할 수 있습니다. Shield의 종류는 다양하며 여러 가지 커넥터를 설치할 수 있습니다. Blackmagic Duplicator 4K를 제어하기 위해서는 이더넷 실드가 필요합니다. 다기능 버튼으로 실드를 추가로 구입할 수도 있습니다. 아두이노 마이크로컨트롤러는 설치가 간단하며 경제적이고 완전한 오픈소스를 기반으로 합니다. 아두이노 소프트웨어의 프로그래밍 작업이 완료되면 아두이노를 Blackmagic Duplicator 4K의 이더넷 포트에 연결하고 바로 제어를 시작할 수 있습니다.

아두이노를 통한 제어 예시

아두이노 마이크로컨트롤러는 일반 C 프로그래밍 언어를 사용하여 프로그래밍합니다. HyperDeck 이더넷 프로토콜을 사용하여 컨트롤러가 명령어를 Blackmagic Duplicator 4K에서 작동시키도록 프로그래밍합니다. 모든 지원 명령어는 다음 [Blackmagic HyperDeck 이더넷 프로토콜] 부분에서 확인할 수 있습니다.

다른 확장 실드를 아두이노에 추가하여 다양한 녹화 기능을 수행할 수 있습니다. 예를 들어, 내부 시계를 추가하면 컨트롤러에서 Blackmagic Duplicator 4K가 특정 시간에 녹화를 진행하도록 지시할 수 있으며, 보안 녹화를 계획할 시에 유용하게 사용할 수 있는 기능입니다.

이러한 놀라운 기술을 제공할 수 있어 상당히 기쁘며 사용자가 직접 제작한 외부 이더넷 컨트롤러 소식 또한 들려주시기 바랍니다.

```

BlackmagicDuplicatorControl | Arduino 1.6.5

BlackmagicDuplicatorControl
/*
 * telnet client Blackmagic Duplicator 4K Control
 *
 * Circuit:
 * Ethernet shield attached to pins 10, 11, 12, 13
 */
#include <SPI.h>
#include <Ethernet.h>

// Enter a MAC address and IP address for your controller below.
// The IP address will be dependent on your local network:
byte mac[] = {0x90, 0xA2, 0xDA, 0x0F, 0x17, 0xEF};
byte ip[] = {192, 168, 28, 204}; //IP address of Ethernet Shield
byte server[] = {192, 168, 28, 85}; //IP address of Duplicator

EthernetClient client; //Give the ethernet client a name

void setup()
{
  Ethernet.begin(mac, ip); //Start the Ethernet connection:
  client.connect(server, 9993); //Connect to Duplicator on port 9993
}

void loop()
{
  while (client.available()) //Read the Duplicator Preamble
  {
    char c = client.read();
  }

  client.print("record: name: CAMERA1\x0a"); //Start Duplicator recording a clip named Camera 1
  delay(60000); //Wait a minute
  client.print("stop\x0a"); //Stop recording
  while (1); //Do nothing until program starts again
}

Sketch uses 9,710 bytes (30%) of program storage space. Maximum is 32,256 bytes.
Global variables use 236 bytes (11%) of dynamic memory, leaving 1,812 bytes for local variables. Maximum is 2,048 bytes.
36 Arduino/Genuino Uno on /dev/cu.usbmodem1421
  
```

이더넷 실드를 사용한 아두이노와 같은 외부 이더넷 컨트롤러를 프로그래밍한 다음에는 이더넷 프로토콜 레퍼런스를 사용하여 원하는 제어 기능에 필요한 명령어를 선택하세요.

위 윈도우에서 볼 수 있는 코드는 다음 페이지에 나와 있으므로 이를 복사하여 아두노이 IDE에 붙여넣기 할 수 있습니다. 이 코드를 통해 아두노이에서 Blackmagic Duplicator 4K가 1분 동안 녹화를 진행한 뒤, 녹화를 중단하고 프로그램이 다시 운영될 때까지 기다리도록 지시할 수 있습니다.

```

/*
   Telnet client Blackmagic Duplicator 4K Control Circuit: *
 Ethernet shield attached to pins 10, 11, 12, 13
 */
#include <SPI.h>
#include <Ethernet.h>

// Enter a MAC address and IP address for your controller below.
// The IP address will be dependent on your local network:
byte mac[] = {0x90, 0xA2, 0xDA, 0x0F, 0x17, 0xEF};
byte ip[] = {192, 168, 28, 204};          // IP address of Ethernet
Shield
byte server[] = {192, 168, 28, 141};     // IP address of Duplicator
EthernetClient client;                  // Give the ethernet client
a name

void setup()
{
  Ethernet.begin(mac, ip); //Start the Ethernet connection:

  client.connect(server, 9993);          //Connect to Duplicator on
port 9993
}
void loop()
{
  while (client.available())           //Read the Duplicator Preamble
  {
    char c = client.read();
  }
  client.print("record: name: Camera1\x0a");
  //Start Duplicator recording a clip named Camera 1
  delay(60000);                        //Wait a minute
  client.print("stop\x0a");            //Stop recoding
  while (1);                          //Do nothing until program starts
again
}

```

Blackmagic HyperDeck 이더넷 프로토콜

Blackmagic Duplicator 이더넷 프로토콜은 텍스트 기반의 프로토콜로 본래 이더넷 포트를 통해 Blackmagic HyperDeck 디스크 리코더를 제어하기 위한 프로토콜이지만, Blackmagic Duplicator 4K 제어를 위한 프로토콜로도 사용할 수 있습니다.

듀플리케이터는 녹화만 진행하기 때문에 전체 HyperDeck 프로토콜 명령어가 없습니다. 하지만 다음 부분에서는 듀플리케이터에서 HyperDeck 이더넷 프로토콜을 사용할 시에 적절한 명령어를 제시합니다.

Protocol Commands

Command	Command Description
help or ?	Provides help text with all commands and parameters.
remote	Queries the state of HyperDeck's remote control mode.
remote: enable: true	Enables remote control.
remote: enable: false	Disables remote control.
remote: override: true	Turns remote override on.
remote: override: false	Turns remote override off.
quit	Disconnects HyperDeck server.
ping	Determines HyperDeck server is responding.
record	Starts recording.
record: append: true	Starts appended recording.
stop	Stops playback or recording.
commands	Lists all supported commands in an XML format.
notify	Queries the current state of all notifications.
notify: transport: true	Enables transport notifications.
notify: transport: false	Disables transport notifications.
notify: slot: true	Enables slot notifications.
notify: slot: false	Disables slot notifications.
notify: remote: true	Enables remote notifications.
notify: remote: false	Disables remote notifications.
notify: configuration: true	Enables configuration notifications.
notify: configuration: false	Disables configuration notifications.
notify: dropped frames: true	Enables dropped frames notifications.
notify: dropped frames: false	Disables dropped frames notifications.
device info	Provides device information.
slot info: slot id: {slot ID}	Provides information about a specified slot.
transport info	Provides information for the state of the transport.
configuration	Queries the current configuration.
configuration: record mode: Duplicate	Configures the record mode to duplicate.
configuration: record mode: SingleDisk	Configures the record mode to single disk.

Command	Command Description
configuration: record mode: DiskOverwrite	Configures the record mode to disk overwrite.
configuration: video input: {"SDI", "optical"}	Configures video input.
configuration: file format: {format}	Configures the record codec and bit rate.
format: prepare: {format}	prepare a disk formatting operation to filesystem {format}
format: confirm: {token}	perform a pre-prepared formatting operation using token
watchdog: period: {seconds}	Configures the watchdog.

Using XML

While you can use the Terminal to talk to HyperDeck, if you are writing software you can use XML to confirm the existence of a specific command based on the firmware of the HyperDeck you are communicating with. This helps your software user interface adjust to the capabilities of the specific HyperDeck model and software version.

Protocol Details

Connection

The HyperDeck Ethernet server listens on TCP port 9993.

Basic syntax

The HyperDeck protocol is a line oriented text protocol. Lines from the server will be separated by an ascii CR LF sequence. Messages from the client may be separated by LF or CR LF.

New lines are represented in this document as a "↵" symbol.

Command syntax

Command parameters are usually optional. A command with no parameters is terminated with a new line:

```
{Command name}↵
```

If parameters are specified, the command name is followed by a colon, then pairs of parameter names and values. Each parameter name is terminated with a colon character:

```
{Command name}: {Parameter}: {Value} {Parameter}: {Value} ...↵
```

Response syntax

Simple responses from the server consist of a three digit response code and descriptive text terminated by a new line:

```
{Response code} {Response text}↵
```

If a response carries parameters, the response text is terminated with a colon, and parameter name and value pairs follow on subsequent lines until a blank line is returned:

```
{Response code} {Response text}:↵
```

```
{Parameter}: {Value}↵
```

```
{Parameter}: {Value}↵
```

```
...
```

```
↵
```

Successful response codes

A simple acknowledgement of a command is indicated with a response code of 200:

```
200 ok↵
```

Other successful responses carry parameters and are indicated with response codes in the range of 201 to 299.

Failure response codes

Failure responses to commands are indicated with response codes in the range of 100 to 199:

```
100 syntax error
101 unsupported parameter
102 invalid value
103 unsupported
104 disk full
105 no disk
106 disk error
109 out of range
110 no input
111 remote control disabled
120 connection rejected
150 invalid state
```

Asynchronous response codes

The server may return asynchronous messages at any time. These responses are indicated with response codes in the range of 500 to 599:

```
5xx {Response Text}:↵
{Parameter}: {Value}↵
{Parameter}: {Value}↵
↵
```

Connection response

On connection, an asynchronous message will be delivered:

```
500 connection info:↵
protocol version: {Version}↵
model: {Model Name}↵
↵
```

Connection rejection

Only one client may connect to the server at a time. If other clients attempt to connect concurrently, they will receive an error and be disconnected:

```
120 connection rejected↵
```

Timecode syntax

Timecodes are expressed as non-drop-frame timecode in the format:

```
HH:MM:SS:FF
```

Handling of deck "remote" state

The "remote" command may be used to enable or disable the remote control of the deck. Any attempt to change the deck state over ethernet while remote access is disabled will generate an error:

```
111 remote control disabled↵
```

To enable or disable remote control:

```
remote: enable: {"true", "false"} ↵
```

The current remote control state may be overridden allowing remote access over ethernet irrespective of the current remote control state:

```
remote: override: {"true", "false"} ↵
```

The override state is only valid for the currently connected ethernet client and only while the connection remains open.

The "remote" command may be used to query the remote control state of the deck by specifying no parameters:

```
remote↵
```

The deck will return the current remote control state:

```
210 remote info:↵
enabled: {"true", "false"}↵
override: {"true", "false"}↵
↵
```

Asynchronous remote control information change notification is disabled by default and may be configured with the "notify" command. When enabled, changes in remote state will generate a "510 remote info:" asynchronous message with the same parameters as the "210 remote info:" message.

Closing connection

The "quit" command instructs the server to cleanly shut down the connection:

```
quit↵
```

Checking connection status

The "ping" command has no function other than to determine if the server is responding:

```
ping↵
```

Getting help

The "help" or "?" commands return human readable help text describing all available commands and parameters:

```
help↵
```

or:

```
?↵
```

The server will respond with a list of all supported commands:

```
201 help:↵
{Help Text}↵
{Help Text}↵
↵
```

Stopping deck operation

The "stop" command instructs the deck to stop the current capture:

```
stop↵
```

Enumerating supported commands and parameters

The "commands" command returns the supported commands:

```
commands↵
```

The command list is returned in a computer readable XML format:

```
212 commands:
<commands>↵
  <command name="..."><parameter name="..." />...</command>↵
  <command name="..."><parameter name="..." />...</command>↵
  ...
</commands>↵
↵
```

More XML tokens and parameters may be added in later releases.

Controlling asynchronous notifications

The "notify" command may be used to enable or disable asynchronous notifications from the server. To enable or disable transport notifications:

```
notify: transport: {"true", "false"}↵
```

To enable or disable slot notifications:

```
notify: slot: {"true", "false"}↵
```

To enable or disable remote notifications:

```
notify: remote: {"true", "false"}↵
```

To enable or disable configuration notifications:

```
notify: configuration: {"true", "false"}↵
```

To enable or disable dropped frames notifications:

```
notify: dropped frames: {"true", "false"}↵
```

Multiple parameters may be specified. If no parameters are specified, the server returns the current state of all notifications:

```
209 notify:↵
transport: {"true", "false"}↵
slot: {"true", "false"}↵
remote: {"true", "false"}↵
configuration: {"true", "false"}↵
↵
```

Retrieving device information

The "device info" command returns information about the connected deck device:

```
device info↵
```

The server will respond with:

```
204 device info:↵
protocol version: {Version}↵
model: {Model Name}↵
unique id: {unique alphanumeric identifier}↵
↵
```

Example of response from server:

```
204 device info:↵
protocol version: 1.8↵
model: Blackmagic Duplicator 4K↵
unique id: 101112131415↵
↵
```

Retrieving slot information

The "slot info" command returns information about a slot.

The specified slot will be queried:

```
slot info: slot id: {Slot ID}↵
```

The server will respond with slot specific information:

```
202 slot info:↵
slot id: {Slot ID}↵
status: {"empty", "mounting", "error", "mounted"}↵
volume name: {Volume name}↵
recording time: {recording time available in seconds}↵
video format: {disk's default video format}↵
↵
```

Asynchronous slot information change notification is disabled by default and may be configured with the "notify" command. When enabled, changes in slot state will generate a "502 slot info:" asynchronous message with the same parameters as the "202 slot info:" message.

Retrieving transport information

The "transport info" command returns the state of the transport:

```
transport info ↵
```

The server responds with transport specific information:

```
208 transport info:↵  
status: {"stopped","record"}↵  
display timecode: {timecode}↵  
timecode: {timecode}↵
```

The "timecode" value is the timecode within the current timeline for playback or the clip for record. The "display timecode" is the timecode displayed on the front of the deck. The two timecodes will differ in some deck modes.

Asynchronous transport information change notification is disabled by default and may be configured with the "notify" command. When enabled, changes in transport state will generate a "508 transport info:" asynchronous message with the same parameters as the "208 transport info:" message.

Video Formats

The following video formats are currently supported on Blackmagic Duplicator 4K:

SD

525i59.94 NTSC

625i50 PAL

HD

720p50	1080p30
720p59.94	1080i50
720p60	1080p50
1080p23.98	1080i59.94
1080p24	1080p59.94
1080p25	1080i60
1080p29.97	1080p60

Ultra HD

2160p23.98	2160p30
2160p24	2160p50
2160p25	2160p59.94
2160p29.97	2160p60

Duplicator 4K supports progressive segmented frame modes, and automatically detects level A and level B 3G-SDI formats for 1080p50, 1080p59.94 and 1080p60.

File Formats

Duplicator 4K supports the following file formats:

- H.264Low
- H.264Medium
- H.264High
- H.265Low
- H.265Medium
- H.265High

Querying and updating configuration information

The "configuration" command may be used to query the current configuration of the deck:

```
configuration↵
```

The server returns the configuration of the deck:

```
211 configuration:↵  
video input: {"SDI", "optical"}↵  
↵
```

One or more configuration parameters may be specified to change the configuration of the deck.

To change the current video input:

```
configuration: video input: {"SDI", "optical"}↵
```

Configuring the watchdog

The "watchdog" command instructs the deck to monitor the connected client and terminate the connection if the client is inactive for at least a specified period of time.

To configure the watchdog:

```
watchdog: period: {period in seconds}↵
```

To avoid disconnection, the client must send a command to the server at least every {period} seconds. Note that if the period is set to 0 or less than 0, connection monitoring will be disabled.

Configuring the record mode

Use the 'record mode' command to select the deck recording mode:

```
configuration: record mode: {"Duplicate", "SingleDisk",  
"DiskOverwrite"}↵
```

Configuring the file format

The 'file format' command instructs the deck to switch to a specific file format for codec and bit rate:

```
configuration: file format: {"H.264High", "H.264Medium", "H.264Low",  
"H.265High", "H.265Medium", "H.265Low"}↵
```

지원

지원 받기

가장 빠르게 지원 받을 수 있는 방법은 Blackmagic Design 온라인 고객지원 페이지에 접속하여 Blackmagic Duplicator 4K 관련 최신 지원 정보를 확인하는 것입니다.

Blackmagic Design 온라인 고객지원 페이지

최신 사용 설명서, 소프트웨어, 지원 노트는 Blackmagic 고객지원 센터 (www.blackmagicdesign.com/kr/support)에서 확인하실 수 있습니다.

Blackmagic Design 포럼

저희 웹사이트에 있는 Blackmagic Design 포럼은 유용한 정보를 제공하는 곳으로, 방문을 통해 자세한 정보와 창의적인 아이디어를 얻을 수 있습니다. 또한, 숙련된 사용자들이나 Blackmagic Design 직원들이 기존에 올려놓은 해결책을 통해 원하는 해답을 얻을 수도 있으므로 여러 가지 도움을 빠르게 받아 한 단계 성장할 수 있는 방법이기도 합니다. 포럼은 <http://forum.blackmagicdesign.com>를 통해 방문할 수 있습니다.

Blackmagic Design 고객 지원에 문의하기

고객 지원 페이지나 포럼에서 원하는 정보를 얻지 못한 경우에는 [이메일 보내기] 버튼을 클릭하여 지원 요청 이메일을 보내주세요. 다른 방법으로는, 고객 지원 페이지의 [지역별 고객 지원팀 찾기] 버튼을 클릭하여 가장 가까운 Blackmagic Design 고객 지원 사무실에 문의하실 수 있습니다.

현재 설치된 소프트웨어 버전 확인하기

About Blackmagic Duplicator Utility 창을 열어 설치된 Blackmagic Duplicator Utility 소프트웨어 버전을 확인하세요.

- Mac OS에서는 애플리케이션 폴더에 있는 Blackmagic Duplicator Utility를 실행합니다. 애플리케이션 메뉴에서 About Blackmagic Duplicator Utility를 선택하면 버전 번호가 나타납니다.
- Windows 8.1에서는 시작 페이지 Blackmagic Duplicator Utility 타일에 있는 Blackmagic Duplicator Utility를 엽니다. 도움말 메뉴를 클릭한 뒤 About Blackmagic Duplicator Utility를 선택하고 버전을 확인하십시오.
- Windows 10에서는 시작 메뉴에서 Blackmagic Camera Utility를 실행합니다. 도움말 메뉴를 클릭한 뒤 About Blackmagic Duplicator Utility를 선택하고 버전을 확인하십시오.

최신 버전 소프트웨어 업데이트하기

컴퓨터에 설치된 Blackmagic Duplicator Utility 소프트웨어 버전을 확인한 뒤, Blackmagic Design 고객 지원 센터(www.blackmagicdesign.com/kr/support)에 방문하여 최신 업데이트 여부를 확인하세요. 최신 버전으로 업데이트하는 것을 권장하지만, 중요한 프로젝트를 실행하는 도중에는 소프트웨어 업데이트를 하지 않는 것이 좋습니다.

규제 사항

유럽 연합 국가 내의 전기전자제품 폐기물 처리 기준.



제품에 부착된 기호는 해당 제품을 다른 폐기물과는 별도로 처리되어야 함을 나타냅니다. 제품을 폐기하려면 반드시 재활용 지정 수거 장소에 폐기해야 합니다. 폐기물 제품을 분리수거 및 재활용으로 처리하는 것은 자연 자원을 보전하고 인간의 건강과 환경을 보호할 수 있도록 폐기물을 재활용할 수 있는 방법입니다. 재활용을 위한 제품 폐기물 장소에 관한 자세한 정보는 해당 지역 시청의 재활용 센터 혹은 해당 제품을 구입한 상점으로 문의하십시오.



본 제품은 테스트 결과 FCC 규정 제15항에 따라 A급 디지털 기기 제한 사항을 준수하는 것으로 확인되었습니다. 해당 제한 사항은 본 제품을 상업적 환경에서 사용할 시 발생할 수 있는 유해 혼선으로부터 적절한 보호를 제공하기 위함입니다. 이 제품은 무선 주파수를 생성 및 사용, 방출할 수 있습니다. 따라서 설명서의 안내에 따라 제품을 설치 및 사용하지 않을 시, 무선 통신을 방해하는 전파 혼선을 일으킬 수 있습니다. 해당 제품을 주거 지역에서 작동할 경우 유해 전파 혼선이 발생할 가능성이 있으며, 이 경우 사용자는 자체 비용으로 전파 혼선 문제를 해결해야 합니다.

제품 작동은 다음 두 가지 조건을 전제로 합니다.

- 1 본 기기는 유해 혼신을 일으키지 않습니다.
- 2 본 기기는 원치 않는 동작을 유발할 수 있는 혼신을 포함한 수신되는 모든 혼신을 수용해야 합니다.

ISED 캐나다 성명

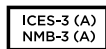

본 기기는 캐나다 표준 A급 디지털 장치 규정을 준수합니다.

정해진 사용 목적 이외의 다른 목적의 사용 또는 제품 변경은 표준 규정 위반으로 간주할 수 있습니다.

이 기기는 업무용 환경에서 사용할 목적으로 적합성 평가를 받은 기기로서 가정용 환경에서 사용하는 경우 전파간섭의 우려가 있습니다.

안전 정보

감전 예방을 위하여 본 제품은 반드시 보호 접지가 되어있는 메인 콘센트에 연결해야 합니다. 확실하지 않을 경우 자격증이 있는 전기공에 연락하십시오.

감전사고 위험을 줄이기 위해서 본 제품을 물이 튀거나 젖는 곳에 두지 마십시오.

본 제품은 주위 온도가 최대 40°C인 열대 지역에서 사용하기 적합합니다.

공기가 잘 통할 수 있도록 제품을 통풍이 잘되는 곳에 둡니다.

장비랙에 제품을 설치할 시, 주변 장비가 제품 통풍에 방해가 되지 않도록 주의하세요.

제품 내부에는 사용자가 수리 가능한 부품이 없습니다. 제품 수리는 해당 지역 Blackmagic Design 서비스 센터에 문의하세요.

일부 제품은 소형 폼팩터 플러그(SFP) 광섬유 모듈 옵션에 연결할 수 있는 기능을 가지고 있습니다. 레이저 클래스 1 광섬유 SFP 모듈만 사용할 수 있습니다.

사용 권장 Blackmagic Design SFP 모듈:

- 3G-SDI: PL-4F20-311C
- 6G-SDI: PL-8F10-311C
- 12G-SDI: PL-TG10-311C



최대 작동 고도는 해수면 기준 2000m까지만 사용할 수 있습니다.

캘리포니아주 성명

본 제품을 사용하는 사용자는 6가 크롬을 포함한 화학 물질에 노출될 수 있으며, 이는 암, 선천적 결손증, 기타 생식기능의 손상을 유발하는 것으로 알려져 있습니다.

더욱 자세한 정보는 www.P65Warnings.ca.gov을 확인하세요.

공인 서비스 직원을 위한 경고

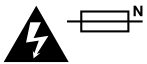

주의 - 쌍극/중립 퓨즈

본 제품에 포함된 전원 장치의 선도체와 중성선에는 퓨즈가 있으므로 노르웨이의 IT 배전 시스템 연결에 적합합니다.

보증

12개월 제한 품질 보증

Blackmagic Design은 Blackmagic Duplicator 4K 제품의 부품 및 제조에 어떠한 결함도 없음을 제품 구매일로부터 12개월 동안 보증합니다. 보증 기간 내에 결함이 발견될 경우, Blackmagic Design은 당사의 결정에 따라 무상 수리 또는 새로운 제품으로 교환해드립니다.

구매 고객은 반드시 보증 기간이 만료되기 전에 결함 사실을 Blackmagic Design에 통지해야 적절한 보증 서비스를 제공받을 수 있습니다. 구매 고객은 지정된 Blackmagic Design 서비스 센터로 결함 제품을 포장 및 운송할 책임이 있으며 운송 비용은 선불로 지급되어야 합니다. 구매 고객은 또한 이유를 불문하고 제품 반송에 대한 운송료와 보험, 관세, 세금, 기타 비용을 부담해야 합니다.

이 보증은 부적절한 사용 및 관리, 취급으로 인한 파손, 고장, 결함에는 적용되지 않습니다. Blackmagic Design은 다음과 같은 경우에 보증 서비스를 제공할 의무가 없습니다. a) Blackmagic Design 판매 대리인이 아닌 개인에 의해 발생한 제품 손상. b) 부적절한 사용 및 호환하지 않는 장비와의 연결로 인한 제품 손상. c) Blackmagic Design사의 부품 및 공급품이 아닌 것을 사용하여 발생한 손상 및 고장. d) 제품을 개조하거나 다른 제품과 통합하여 제품 작동 시간 증가 및 기능 저하가 발생한 경우. BLACKMAGIC DESIGN에서 제공하는 제품 보증은 다른 모든 명시적 또는 묵시적 보증을 대신합니다. BLACKMAGIC DESIGN사와 관련 판매 회사는 상품성 및 특정 목적의 적합성과 관련된 모든 묵시적 보증을 부인합니다. 구매 고객에게 제공되는 BLACKMAGIC DESIGN의 결함 제품 수리 및 교환 관련 책임은 BLACKMAGIC DESIGN 또는 판매 회사에서 관련 위험의 가능성에 대한 사전 통보의 여부와 관계없이 모든 간접적, 특별, 우발적, 결과적 손해에 대한 유일한 배상 수단입니다. BLACKMAGIC DESIGN은 고객이 사용한 불법 장비에 대해서는 어떤 법적 책임도 지지 않습니다. BLACKMAGIC은 본 제품의 사용으로 인해 발생하는 손해에 대해서는 어떤 법적 책임도 지지 않습니다. 제품 사용으로 인해 발생할 수 있는 위험에 대한 책임은 본인에게 있습니다.

© 저작권 2019 Blackmagic Design. 모든 권리 보유. 'Blackmagic Design', 'DeckLink', 'HDLINK', 'Workgroup Videohub', 'Videohub', 'DeckLink', 'Intensity', 'Leading the creative video revolution'은 모두 미국 및 기타 국가에 등록된 상표입니다. 다른 회사명 및 제품 이름은 관련 회사의 등록 상표일 수 있습니다. Thunderbolt와 Thunderbolt 로고는 미국 및 기타 국가에서 등록된 Intel Corporation의 상표입니다.

Blackmagicdesign



Руководство по установке и эксплуатации

Blackmagic Duplicator 4K

Февраль 2019 г.

Русский



Добро пожаловать!

Благодарим вас за покупку Blackmagic Duplicator 4K.

Это решение предназначено для качественного тиражирования видеоматериала и идеально подходит для прямого распространения копий в Ultra HD. Дубликатор позволяет вести запись на 25 SD-карт во всех разновидностях SD-, HD- и Ultra HD-форматов до 2160p/60. Широко применяемый стандарт сжатия H.264 или новейший H.265 обеспечивают поддержку высокой кадровой частоты при минимальном битрейте. Это дает возможность использовать недорогие носители и уместать на них большой объем данных.

Blackmagic Duplicator 4K отличается простотой и удобством в работе. Для изменения настроек используют переднюю панель с кнопками и ЖК-дисплеем. Управлять устройством в удаленном режиме можно через локальную сеть Ethernet, с помощью контроллера RS-422 или собственного устройства посредством протокола Blackmagic HyperDeck Ethernet Protocol.

Встроенный кодер H.265 обеспечивает запись высококачественного видео на недорогие SD-карты в форматах вплоть до 2160p/60, поэтому для работы с Ultra HD не придется приобретать самые скоростные носители. ПО последней версии 1.2 также позволяет использовать стандарт сжатия H.264, что дает еще больше возможностей при создании контента с помощью Blackmagic Duplicator 4K.

Blackmagic Duplicator 4K занимает одно место в стойке и позволяет последовательно соединять несколько устройств в одну цепь для одновременного создания сотен копий.

Это руководство содержит всю информацию, необходимую для работы с Blackmagic Duplicator 4K.

Последнюю версию руководства и программного обеспечения для Blackmagic Duplicator 4K можно найти в разделе поддержки на веб-сайте www.blackmagicdesign.com. Использование актуальной версии ПО дает доступ ко всем имеющимся функциям. Чтобы узнавать о выходе обновлений, не забудьте зарегистрироваться при загрузке программного обеспечения. Мы продолжаем работать над совершенствованием наших продуктов, поэтому ваши отзывы помогут нам сделать их еще лучше!

A handwritten signature in black ink that reads "Grant Petty". The signature is written in a cursive, flowing style.

Grant Petty

CEO Blackmagic Design

Содержание

Blackmagic Duplicator 4K

Подготовка к работе	265
Подключение питания	265
Подключение источников видео- и аудиосигнала	265
Последовательное соединение	266
Установка и форматирование SD-карт	267
Запись	268
Выбор режима записи	268
Выбор кодека	269
Установка битрейта	270
Запись клипов	271
Светодиодные индикаторы состояния	271
Режим Append	272
Блокировка Blackmagic Duplicator 4K	273
Последовательное соединение нескольких устройств Blackmagic Duplicator 4K	273
Настройки меню на ЖК-дисплее	275
Record	275
Настройки	280
About	281
Blackmagic Duplicator Utility	281
Обновление прошивки Blackmagic Duplicator 4K	281
File Name Prefix	281
Установка дополнительного оптического модуля	282
Управление по протоколу RS-422	283
Протокол RS-422	283
Использование внешнего контроллера RS-422	283
RS-422 Developer Information	285
Дистанционное управление по сети Ethernet	285
Управление с помощью Arduino	286
Blackmagic HyperDeck Ethernet Protocol	288
Protocol Commands	288
Protocol Details	289
Configuring the watchdog	294
Configuring the record mode	294
Configuring the file format	294
Помощь	295
Соблюдение нормативных требований	296
Правила безопасности	297
Гарантия	298

Подготовка к работе

Blackmagic Duplicator 4K является простым в эксплуатации устройством.

Чтобы приступить к работе, достаточно подключить источник SDI-сигнала и установить от одной до 25 SD-карт. Если количество копий нужно увеличить, соедините несколько устройств Blackmagic Duplicator 4K в одну цепь, используя имеющиеся разъемы и порты управления. Ниже описан порядок настройки, после выполнения которой можно начинать одновременную запись одной программы на несколько носителей.

Подключение питания

Для подачи питания соедините силовой кабель по стандарту IEC со входом 110-240 В переменного тока на задней панели Blackmagic Duplicator 4K.

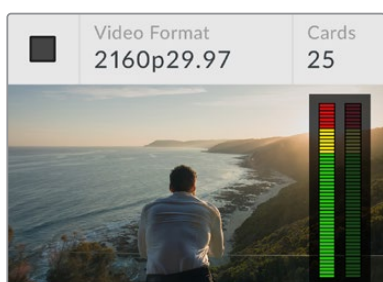

Когда устройство включено, на его ЖК-дисплее отображается начальная страница

Начальная страница

На начальной странице отображаются поступающее изображение, его формат, количество установленных SD-карт, состояние записи и индикаторы звука, которые позволяют отслеживать уровень аудиодорожки.

Подключение источников видео- и аудиосигнала

Подключите источник видео ко входу 12G-SDI на задней панели. Blackmagic Duplicator 4K автоматически определит формат поступающего изображения и отобразит его на начальной странице ЖК-дисплея.

Разъемы BNC на входе и выходе обеспечивают работу с 12G-SDI, поэтому для передачи SD-, HD- и Ultra HD-видео в форматах до 2160p/60 требуется только один кабель. Blackmagic Duplicator 4K имеет сквозной тракт, который можно использовать для вывода сигнала на другое SDI-оборудование или последовательного соединения нескольких устройств в одну цепь. Дополнительно предусмотрены поддержка режима PSF (прогрессивные сегментированные кадры) и автоматическое определение уровней (3G-SDI Level A и Level B) для 1080p/50, 1080p/59,94 и 1080p/60.

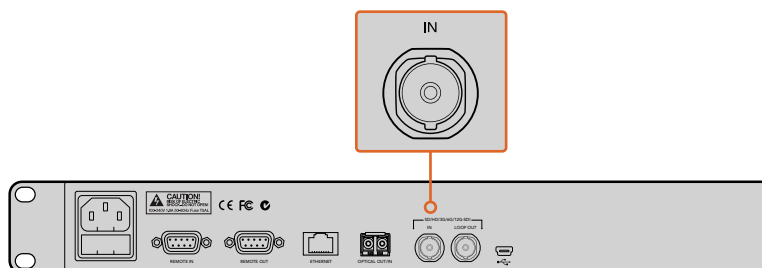

Подключите источник сигнала к SDI-входу. Звук будет встроен в видеопоток.

Blackmagic Duplicator 4K поддерживает два канала звука, встроенного в SDI-поток, поэтому для обработки аудиодорожки отдельные соединения не требуются.

СОВЕТ. На начальной странице ЖК-дисплея можно следить за уровнями аудиодорожки в источнике видеосигнала.

Последовательное соединение

Дубликаторы Blackmagic Duplicator 4K можно объединять в одну цепь, если необходимо увеличить количество тиражируемых копий. Например, для записи на 100 карт потребуется четыре устройства, последовательно подключенных друг к другу.

- 1 Соедините кабелем выход REMOTE OUT порта RS-422 на первом дубликаторе со входом REMOTE IN на втором устройстве. Повторите это действие для всех дубликаторов в цепи.
- 2 Соедините сквозной SDI-выход LOOP OUT на первом устройстве с SDI-входом на втором и повторите это действие для всех устройств в цепи.
- 3 На панели управления есть кнопка REM, которая используется для дистанционного управления при работе с несколькими устройствами. Нажмите эту кнопку на всех Blackmagic Duplicator 4K, начиная со второго дубликатора в цепи.

ПРИМЕЧАНИЕ. Кнопка REM на первом дубликаторе должна быть выключена, а на всех остальных — включена. Первый Blackmagic Duplicator 4K становится главным и позволяет со своей контрольной панели управлять всеми остальными устройствами в цепи. Любое решение, оснащенное портом RS-422, может служить главным, так как этот протокол является стандартным.

Теперь все звенья цепи готовы к выполнению команд, направляемых с первого устройства.

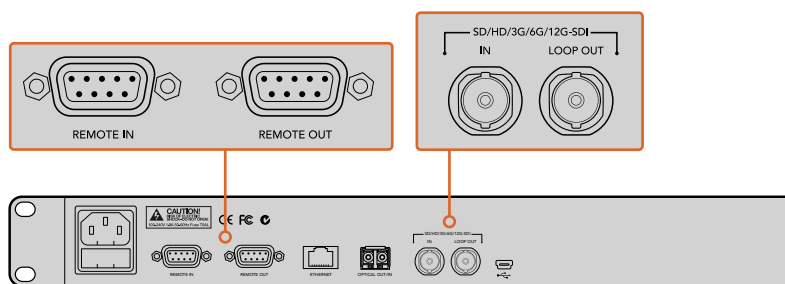

Разъемы REMOTE и LOOP используются для последовательного соединения нескольких дубликаторов. Сквозной тракт на последнем устройстве в цепи также позволяет выводить сигнал на другое SDI-оборудование, например на монитор Blackmagic SmartView или дисковый рекордер HyperDeck.

Более подробно см. раздел «Последовательное соединение нескольких устройств Blackmagic Duplicator 4K».

Установка и форматирование SD-карт

Blackmagic Duplicator 4K работает со стандартными SD-картами класса 10 и не требует использования сверхскоростных носителей. Эти карты доступны в любых специализированных магазинах и некоторых супермаркетах.

СОВЕТ. На наклейке SD-карты есть цифра в кружке — от 1 до 10. Она означает класс скорости записи по возрастающей (10 — самая быстрая). Для записи видео в формате вплоть до Ultra HD с самым высоким битрейтом подойдет SD-карта 10-го класса.

Порядок установки SD-карты

- 1 Возьмите SD-карту так, чтобы ее позолоченные контакты были обращены к ЖК-дисплею панели управления, и вставьте в один из слотов.
- 2 Осторожно нажмите на карту, чтобы она вошла до конца. По окончании проверки светодиодный индикатор загорится зеленым цветом, указывая на готовность к записи.

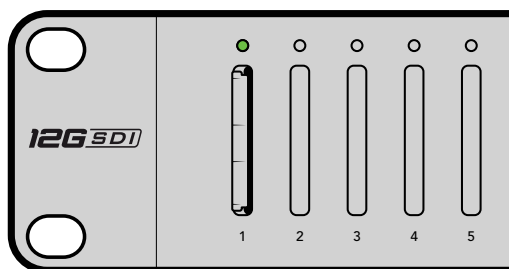
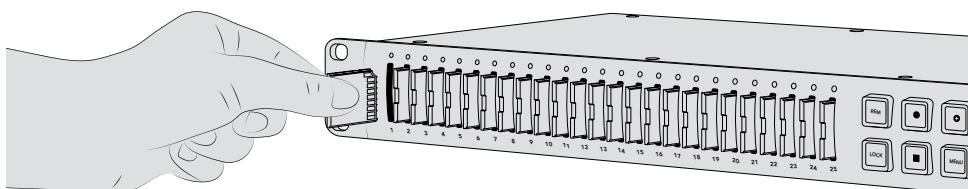

Возьмите SD-карту так, чтобы ее позолоченные контакты были обращены к ЖК-дисплею, и осторожно установите в слот до конца. Когда светодиодный индикатор загорится зеленым цветом, накопитель будет готов к записи.

Для извлечения карты из слота возьмите ее за край и потяните на себя.

СОВЕТ. Убедитесь в том, что карта не имеет защиты от записи. Передвиньте переключатель блокировки на боковой стороне карты в положение рядом с контактами. По окончании работы можно снова включить защиту, вернув переключатель в первоначальное положение.

Форматирование SD-карт

Прежде чем приступить к записи, SD-карты необходимо отформатировать под файловую систему exFAT, работать с которой можно в среде macOS и Windows. Для этого на Blackmagic Duplicator 4K предусмотрена соответствующая функция, позволяющая одновременно готовить до 25 карт на одном устройстве.

Порядок форматирования SD-карт на Blackmagic Duplicator 4K

- 1 Нажмите кнопку MENU на панели управления.
- 2 С помощью кнопки в многофункциональном блоке выберите Record.
- 3 Нажмите кнопку, соответствующую левой стрелке, чтобы выбрать Format Cards, затем кнопку Format в правом нижнем углу.
- 4 Появится сообщение, предлагающее подтвердить форматирование. Нажмите Format, чтобы продолжить, или Cancel для отмены.
- 5 Индикатор выполнения задачи будет отображать состояние форматирования. После окончания нажмите OK.
- 6 Для возврата к начальной странице дисплея нажмите кнопку MENU.

Для возврата к начальной странице дисплея нажмите кнопку MENU.

Все готово для начала работы. После подключения источника видео/аудиосигнала и форматирования SD-карт можно приступить к записи.

СОВЕТ. Продолжительность форматирования зависит от типа и емкости карты. Одни требуют больше времени, другие — меньше.

Запись

Чтобы сразу приступить к тиражированию, можно нажать кнопку записи на панели управления. В большинстве случаев вначале рекомендуется выбрать режим, кодек и битрейт, потому что эти настройки определяют качество изображения и длительность сохранения.

Выбор режима записи

Blackmagic Duplicator 4K имеет несколько режимов записи.

- **Duplicate:** одновременная запись на все SD-карты.
- **Single Disk:** запись на одну SD-карту в порядке очереди и остановка сохранения после заполнения последнего накопителя.
- **Single Disk Overwrite:** запись на одну SD-карту в порядке очереди с повторным сохранением в непрерывном цикле.

Режим Duplicate

В этом режиме видео одновременно записывается на все SD-карты.

Режим Single Disk

Blackmagic Duplicator 4K превосходно подходит для последовательного сохранения видео с камер наблюдения и при работе в эфире. Запись выполняется на одну SD-карту, а при ее заполнении продолжается на следующем накопителе и так по очереди до тех пор, когда будут использованы все из них. Устройство имеет 25 слотов, поэтому общая продолжительность полученного материала может достигать одной недели. Для непрерывной записи достаточно в любой момент заменить полные носители пустыми.

При последовательном соединении нескольких устройств в одну цепь можно дополнительно увеличить время записи. Когда на главном из них все карты будут заполнены, сохранение продолжится на остальных. Запись остановится после использования последнего накопителя на последнем дубликаторе.

Режим Single Disk Overwrite

При установке двух и более SD-карт этот режим позволяет выполнять циклическое сохранение в непрерывном режиме: когда последний накопитель заполнен, запись продолжается на первом. В этом случае активным поочередно является только один слот. Перед повторным использованием носитель подвергается форматированию.

Режимы Single Disk и Single Disk Overwrite похожи друг на друга, однако в первом случае запись останавливается после заполнения последнего накопителя, а во втором выполняется форматирование следующей доступной карты для сохранения на ней нового материала. При выборе опции Single Disk Overwrite для прекращения работы необходимо нажать кнопку остановки.

СОВЕТ. При использовании режимов Single Disk и Single Disk Overwrite пустые SD-карты можно установить в любой момент времени. Запись на Duplicator 4K будет продолжаться до тех пор, пока в любом из 25 слотов есть накопитель со свободным местом.

Порядок выбора режима

- 1 Включите питание на Blackmagic Duplicator 4K.
- 2 Используйте кнопку MENU на передней панели управления, чтобы открыть меню. Клавиши рядом с экраном отображают доступные опции. Нажмите кнопку записи.
Внизу меню Record отображаются точки, которые показывают количество доступных опций. Чтобы вернуться на один уровень вверх, нажмите кнопку Back. Для перехода между различными настройками используйте кнопки < и >.
- 3 Перейдите к настройке Mode и выберите Change.
- 4 Чтобы использовать текущую настройку, нажмите кнопку Select. Меню на экране отображает выбранную опцию.
- 5 Для возврата к меню записи нажмите кнопку Back. На экране отображается выбранная опция.

Подробнее о последовательном соединении нескольких дубликаторов в одну цепь см. соответствующие разделы руководства.

СОВЕТ. Если с настройкой Single Disk или Single Disk Overwrite нужно извлечь SD-карту до ее полного заполнения, нажмите и удерживайте в течение трех секунд кнопку записи. В этом случае сохранение будет продолжено на следующем накопителе. При настройке Duplicate используйте кнопку +. Подробнее см. раздел о режиме Append.

Выбор кодека

Blackmagic Duplicator 4K может вести запись в любом из двух стандартов сжатия: H.264 или H.265. По умолчанию используется компрессия H.264.

Порядок смены кодека

- 1 Нажмите кнопку MENU.
- 2 Нажмите кнопку записи в многофункциональном блоке.
- 3 Используя кнопки со стрелками, перейдите к настройке Codec и нажмите Change.
- 4 Выберите необходимый кодек и нажмите Set, чтобы подтвердить изменение, или MENU, чтобы применить новую настройку и вернуться к начальной странице на ЖК-дисплее.

ПРИМЕЧАНИЕ. Чтобы использовать различные кодеки, на Blackmagic Duplicator 4K должно быть ПО 1.1 или более поздней версии. Подробнее см. раздел «Работа с Blackmagic Duplicator Utility».

Выбор подходящего кодека

Для лучшей совместимости рекомендуется использовать кодек H.264. По этой причине в заводских настройках Blackmagic Duplicator 4K выбран именно этот тип.

Для работы с видео в Ultra HD и экономии места на носителе больше подходит кодек H.265, но он не всегда совместим с компьютерами и другим оборудованием.

Оба кодека имеют свои преимущества. Так как H.265 требует более низкого битрейта и файлы в этом кодеке имеют меньший размер с тем же качеством изображения, можно использовать недорогие SD-карты. Если важнее совместимость с другими устройствами, лучше выбрать H.264.

Установка битрейта

Blackmagic Duplicator 4K имеет три настройки битрейта: Low (низкий), Medium (средний), High (высокий). Они позволяют задавать объем данных на одну секунду видео при кодировании в H.265. По умолчанию используется опция Medium, которая обеспечивает оптимальное соотношение качества и размера файла. При необходимости ее можно изменить.

Порядок изменения битрейта

- 1 Нажмите кнопку MENU.
- 2 Нажмите кнопку Record в многофункциональном блоке.
- 3 Используя кнопки, соответствующие стрелкам, перейдите к настройке Bit Rate и нажмите Change.
- 4 Выберите необходимый битрейт и нажмите Set, чтобы подтвердить изменение, или Menu, чтобы применить новую настройку и вернуться к начальной странице на ЖК-дисплее.

ПРИМЕЧАНИЕ. Чем выше битрейт, тем лучше качество записи, однако такое видео требует больше места и использования достаточно скоростных карт. При более низкой скорости передачи данных на одном носителе можно уместить больше материала, но это скажется на качестве изображения.

Чтобы найти оптимальное соотношение качества и размера файла, рекомендуется попробовать разные битрейты.

Запись клипов

Чтобы начать запись, нажмите соответствующую кнопку на панели управления. Во время сохранения светодиодный индикатор каждого используемого слота горит красным цветом. После остановки индикатор становится зеленым. Это означает, что карта успешно сохранила предыдущий клип и готова к продолжению записи. Для просмотра материала можно использовать компьютер, устройство чтения или HDMI-телевизор, если они поддерживают работу с SD-картами и файловую систему exFAT.

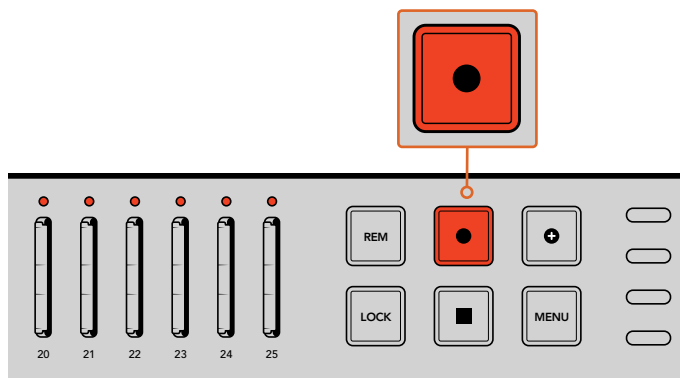

Для начала записи нажмите соответствующую кнопку. После этого светодиодный индикатор каждого слота будет мигать красным цветом.

Светодиодные индикаторы состояния

В зависимости от текущего состояния светодиодный индикатор слота использует разные цвета. Например, после установки SD-карты и во время ее проверки он будет гореть зеленым цветом.

Ниже описаны возможные комбинации состояния дубликатора и цвета индикатора.



Непрерывный зеленый

Можно начинать запись. Индикатор постоянно горит зеленым цветом, когда SD-карта готова к записи.



Непрерывный красный

Идет запись. Индикатор постоянно горит красным цветом во время записи.



Мигающий красный

Идет запись, накопитель почти заполнен. Когда на карте остается место для менее чем трех минут записи, индикатор будет мигать.



Красный (мигает с короткими интервалами)

Пропуск кадров. Установленная SD-карта имеет недостаточные скоростные характеристики.



Непрерывный желтый

Карта заполнена, защищена или непригодна для записи. Если во время записи индикатор непрерывно горит желтым цветом, SD-карта еще не отформатирована, защищена от записи или может вместить видео продолжительностью менее 10 секунд. Попробуйте разблокировать или отформатировать накопитель, уменьшите битрейт или установите другой носитель.

Хотя дубликатор сохраняет файловую систему каждого носителя, рекомендуется не извлекать SD-карту из Blackmagic Duplicator 4K во время записи, так как в противном случае на некоторых компьютерах файлы могут распознаваться как поврежденные. Для безопасного извлечения лучше всего сначала закончить запись. Если отдельные карты необходимо распространить до того, как завершится мероприятие, можно использовать несколько дубликаторов. Это позволяет получать укороченную копию на одном устройстве и полную версию на остальных.

COBET. SD-карты 10-го класса обеспечивают запись с любым битрейтом, который поддерживается на Blackmagic Duplicator 4K. При необходимости можно использовать менее скоростные карты. Например, для записи с камеры видеонаблюдения более важным фактором является продолжительность, а не качество изображения. Рекомендуется всегда выполнить пробную запись, чтобы проверить работу SD-карты с выбранным битрейтом. Подробнее см. главу «Установка и форматирование SD-карт» в разделе «Подготовка к работе».

Режим Append

При использовании настройки Duplicate иногда новый клип необходимо добавить к уже существующему, чтобы сделать единое видео. Особенно часто такая потребность возникает при записи мероприятия, которое состоит из нескольких разрозненных событий. В этом случае можно использовать режим Append, позволяющий создавать целостный материал из отдельных фрагментов.

- 1 Запишите первый клип, используя соответствующую кнопку. Нажмите кнопку остановки.
- 2 Для записи следующего фрагмента нажмите кнопку +. Она загорится вместе с кнопкой обычной записи, что указывает на добавление текущего клипа к предыдущему.
- 3 Нажмите кнопку остановки. Новый клип будет добавлен к ранее записанному и сохранен вместе с ним как единое видео.

COBET. Режим Append позволяет добавлять любое количество клипов к уже существующим. Единственные ограничения — это размер карты памяти и продолжительность записи.

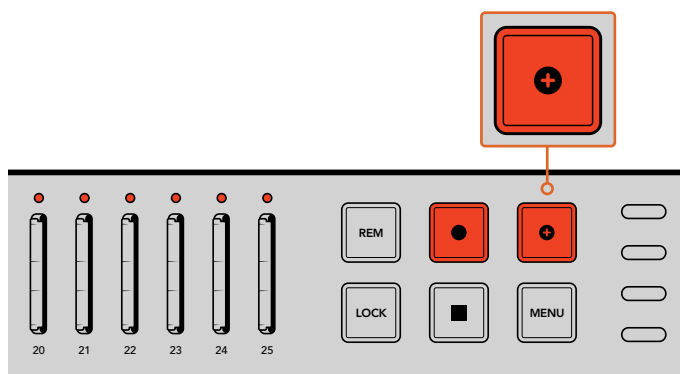

Нажмите кнопку +, чтобы добавить новый клип к записанному ранее

COBET. Если при настройке Single Disk или Single Disk Overwrite необходимо извлечь текущую карту и перейти на работу со следующей, нажмите и удерживайте кнопку записи в течение трех секунд. В этом случае можно получить мгновенный доступ к полученному материалу без остановки сохранения. Подробнее о настройках Single Disk и Single Disk Overwrite см. раздел о выборе способа записи. При настройке Duplicate используйте кнопку +. Подробнее см. раздел о режиме Append.

Блокировка Blackmagic Duplicator 4K

При записи важного события можно заблокировать контрольную панель, чтобы предотвратить случайное нажатие кнопки остановки. Эта функция также полезна для отключения органов управления на ведомых устройствах, объединенных в одну цепь.

Для включения и отключения блокировки используется кнопка LOCK. Случайная разблокировка устройства маловероятна, так как для этого необходимо удерживать кнопку нажатой в течение двух секунд.

Порядок блокировки Blackmagic Duplicator 4K

- 1 Нажмите кнопку LOCK на панели управления дубликатора.
- 2 Чтобы разблокировать устройство, нажмите и удерживайте кнопку LOCK. Через две секунды дубликатор будет разблокирован.

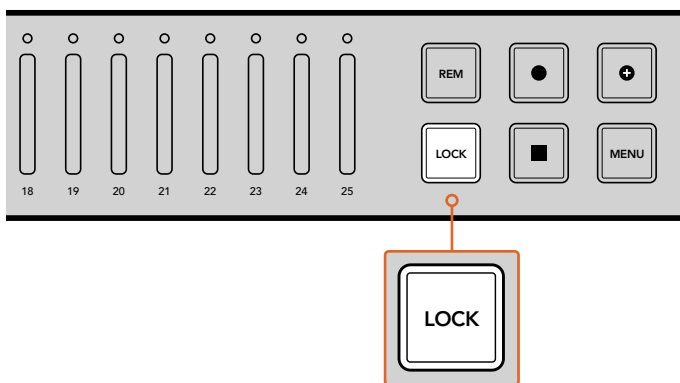

Блокировка контрольной панели позволяет предотвратить случайную остановку записи на Blackmagic Duplicator 4K

Последовательное соединение нескольких устройств Blackmagic Duplicator 4K

Если для записи необходимо использовать более 25 SD-карт, можно объединить в одну цепь несколько дубликаторов. В этом случае каждый из них будет получать один и тот же сигнал через SDI-выход LOOP OUT и использовать разъем REMOTE для приема команд управления по протоколу RS-422.

Порядок последовательного соединения нескольких дубликаторов

- 1 Используя последовательный кабель с разъемом DB-9, подключите выход REMOTE OUT порта RS-422 на первом устройстве ко входу REMOTE IN на втором. Такой кабель можно приобрести в любом магазине компьютерной и видеотехники.
- 2 Соедините сквозной SDI-выход на первом устройстве с SDI-входом на втором.

Если вы используете более двух дубликаторов, повторите описанные выше действия для всех остальных устройств в цепи.

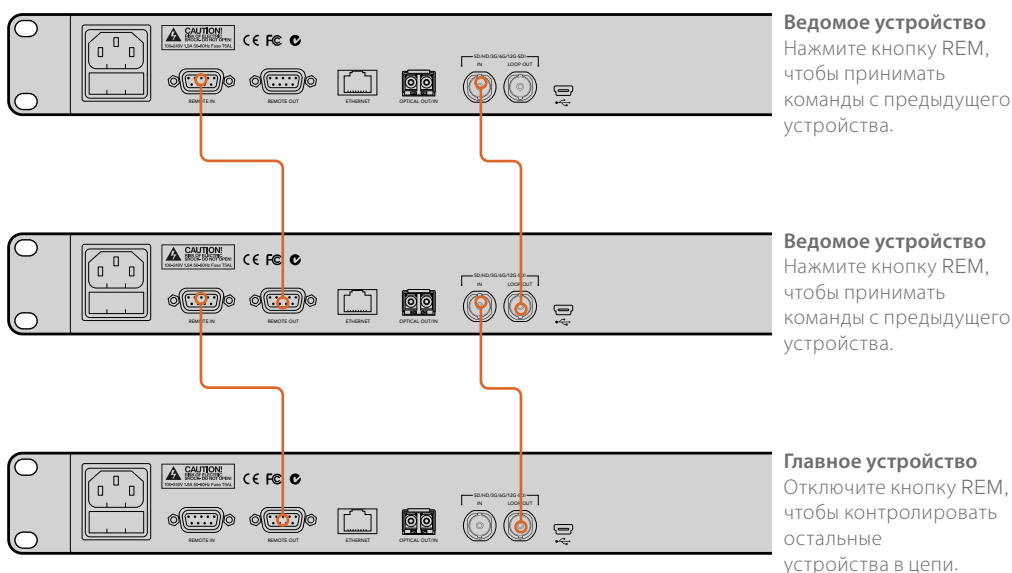

Чтобы объединить несколько дубликаторов в одну цепь, соедините сквозной выход одного устройства с SDI-входом на другом. Затем подключите выход дистанционного управления на первом дубликаторе к соответствующему входу на втором.

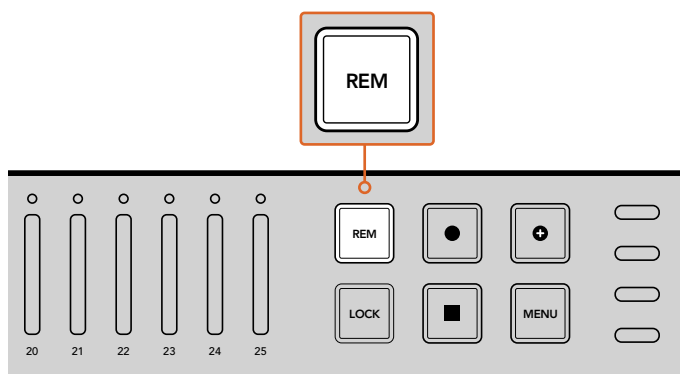

Нажмите кнопку REM на каждом ведомом устройстве в цепи, чтобы активировать управление в дистанционном режиме

ПРИМЕЧАНИЕ. Для дистанционного управления кнопка REM должна быть включена на каждом из ведомых устройств. Когда этот режим активирован, она горит. Чтобы отключить функцию, нажмите кнопку еще раз.

При использовании нескольких дубликаторов рекомендуется предварительно выполнить пробную запись. Если ведомые устройства не принимают команды с главного, убедитесь в том, что на первом дубликаторе кнопка REM отключена, а на всех остальных включена.

Настройки меню на ЖК-дисплее

Все настройки можно изменить с помощью многофункциональных кнопок, расположенных по обеим сторонам ЖК-дисплея. Каждая из них соответствует той или иной настройке, отображаемой на экране.

Порядок изменения настроек

- 1 Нажмите кнопку MENU на панели управления, чтобы открыть настройки.
- 2 Для навигации по меню используйте многофункциональные кнопки.
- 3 После выбора необходимой настройки нажмите кнопку Change.
- 4 Измените настройку и нажмите Set, чтобы подтвердить новую установку.

Для отмены изменения используйте многофункциональную кнопку Back, которая позволяет вернуться на один шаг назад, или нажмите кнопку MENU на панели управления, чтобы вернуться к начальной странице.

Record

Настройка Record позволяет менять источник видео, задавать битрейт, включать или отключать запуск записи и форматировать SD-карты.

Video Source

Эта настройка позволяет выбирать SDI-вход или оптический вход. Во втором случае потребуется установка дополнительного оптического модуля.

Mode (Режим)

Эта настройка позволяет выбрать один из трех режимов записи.

Duplicate

Одновременная запись материала на все SD-карты.

Single Disk

Запись выполняется на одну SD-карту, а при ее заполнении продолжается на следующей. После использования всех накопителей сохранение прекращается. При последовательном соединении нескольких устройств в одну цепь запись останавливается, когда закончится свободное место на последнем доступном носителе.

Single Disk Overwrite

Непрерывная запись в циклическом режиме. Видео сохраняется сначала на одной SD-карте, а при ее заполнении продолжается на следующей. После использования всех накопителей выполняется возврат к первому из них с заменой старого изображения на новое.

Codec

Эта настройка позволяет выбрать кодек сжатия для записи с помощью Blackmagic Duplicator 4K.

Можно использовать один из двух типов кодека.

H.264

Широко применяемый кодек сжатия, который обеспечивает наилучший баланс между качеством изображения и размером файла. Большинство современных устройств для воспроизведения видео способны работать с материалом в этом кодеке с качеством вплоть до HD.

H.265

Высокопроизводительный кодек, позволяющий использовать вдвое меньший объем носителя для материала такого же качества, как видео в H.264. Он отлично подходит как для HD-, так и для Ultra HD-контента, но требует более современных аппаратных и программных решений.

ПРИМЕЧАНИЕ. Подробнее о разнице между кодеками H.264 и H.265 см. раздел «Запись».

Bit Rate

Настройка битрейта определяет размер и качество видео при записи на SD-карты. Можно выбрать одну из трех опций.

High

Высокий битрейт обеспечивает максимально высокое качество с наименьшей компрессией.

Medium

Позволяет уместить больше видео с сохранением высокого качества.

Low

Наибольший объем видео в тех случаях, когда качество не является главным фактором. При использовании этой настройки выполняется максимальное сжатие, что ведет к появлению заметных артефактов.

ПРИМЕЧАНИЕ. Благодаря новейшей технологии сжатия встроенный кодек H.265 обеспечивает высокое качество изображения при минимальном объеме. Качество записи будет хорошим даже при использовании низкого битрейта.

Битрейты для форматов видео

Ultra HD			
Формат видео	Настройка битрейта	Битрейт (Мбит/с) H.264	Битрейт (Мбит/с) H.265
2160p/60	High	75	50
	Medium	66	38
	Low	50	20
2160p/59,94	High	75	50
	Medium	66	38
	Low	50	20

Ultra HD			
Формат видео	Настройка битрейта	Битрейт (Мбит/с) H.264	Битрейт (Мбит/с) H.265
2160p/50	High	72	48
	Medium	61	32
	Low	42	16
2160p/30	High	50	30
	Medium	37	20
	Low	24	10
2160p/29,97	High	50	30
	Medium	37	20
	Low	24	10
2160p/25	High	40	25
	Medium	32	18
	Low	20	10
2160p/24	High	40	25
	Medium	32	18
	Low	20	10
2160p/23,98	High	40	25
	Medium	32	18
	Low	20	10

HD			
Формат видео	Настройка битрейта	Битрейт (Мбит/с) H.264	Битрейт (Мбит/с) H.265
1080p/60	High	40	20
	Medium	32	15
	Low	20	10
1080i/60	High	40	20
	Medium	32	15
	Low	20	10
1080p/59,94	High	40	20
	Medium	32	15
	Low	20	10
1080i/59,94	High	40	20
	Medium	32	15
	Low	20	10
1080p/50	High	36	20
	Medium	28	15
	Low	18	10

HD			
Формат видео	Настройка битрейта	Битрейт (Мбит/с) H.264	Битрейт (Мбит/с) H.265
1080i/50	High	36	20
	Medium	28	15
	Low	18	10
1080p/30	High	28	15
	Medium	20	11
	Low	11	7
1080p/29,97	High	28	15
	Medium	20	11
	Low	11	7
1080p/25	High	24	15
	Medium	16	10
	Low	9	6
1080p/24	High	24	15
	Medium	15	10
	Low	8	6
1080p/23,98	High	24	15
	Medium	15	10
	Low	8	6
720p/60	High	25	12
	Medium	17	10
	Low	9	8
720p/59,94	High	25	12
	Medium	17	10
	Low	9	8
720p/50	High	20	12
	Medium	14	9
	Low	7	6

SD			
Формат видео	Настройка битрейта	Битрейт (Мбит/с) H.264	Битрейт (Мбит/с) H.265
625i/50	High	18	11
	Medium	12	8
	Low	6	6
525i/59,94	High	20	12
	Medium	14	9
	Low	7	6

Trigger

Эта настройка позволяет активировать запуск записи на дубликаторе при нажатии соответствующей кнопки на подключенном к нему SDI-оборудовании, например на Blackmagic URSA Mini.

None

Отключение запуска записи с другого оборудования.

SDI Start/Stop

При выборе этой опции Blackmagic Duplicator 4K будет начинать запись при нажатии соответствующей кнопки на другом SDI-оборудовании.

Например, Blackmagic URSA Mini всегда выводит сигнал запуска на SDI-выход в начале съемки. Если к ней подключен дубликатор, он будет начинать и останавливать запись при нажатии соответствующей кнопки на камере. URSA Mini не требует дополнительного изменения настроек для работы с этим режимом, однако при использовании другого SDI-оборудования с поддержкой данной функции ее нужно предварительно активировать.

Timecode Run

Эта опция позволяет начинать запись при обнаружении тайм-кода, если оборудование не поддерживает запуск и остановку через SDI-интерфейс. Если к Blackmagic Duplicator 4K подключена SDI-камера и на ней активирована настройка "Record run", при нажатии кнопки записи начнется отсчет тайм-кода и сохранение на дубликаторе. После повторного нажатия этой кнопки отсчет тайм-кода прекратится, и запись остановится.

При работе с этой функцией важно помнить, что на оборудовании должна быть выбрана опция "Record run". Если установлена настройка "Time of day", тайм-код будет непрерывно поступать на выход, что приведет к циклической записи на Blackmagic Duplicator 4K.

Форматирование карт

Blackmagic Duplicator 4K позволяет одновременно форматировать до 25 карт.

Порядок форматирования карт

- 1 Нажмите кнопку MENU на панели управления, чтобы открыть меню.
- 2 В многофункциональном блоке нажмите кнопку Record.
- 3 Нажмите кнопку, соответствующую правой или левой стрелке, чтобы перейти к настройке Format Cards, затем выберите Format.
- 4 Появится сообщение, предлагающее подтвердить форматирование, и предупреждение о том, что это действие нельзя отменить. Если SD-карта содержит важные данные, их необходимо предварительно скопировать на другой носитель.
- 5 Нажмите Format для подтверждения или Cancel, чтобы вернуться к настройкам Record.
- 6 Во время форматирования светодиодные индикаторы мигают желтым цветом, а на ЖК-дисплее отображается строка состояния. По окончании форматирования индикаторы будут гореть зеленым цветом, а на ЖК-дисплее появится сообщение о том, что карты готовы к записи.
- 7 Нажмите OK, затем кнопку MENU на панели управления, чтобы вернуться к начальной странице.

Настройки

Меню Settings позволяет менять сетевые параметры дубликатора, в том числе IP Address, Subnet Mask и Gateway, а также включать или выключать режим DHCP. Если Blackmagic Duplicator 4K подключить к локальной сети, им можно управлять дистанционно с помощью приложения Telnet.

DHCP On

Для автоматической установки настроек при подключении дубликатора к локальной сети выберите опцию On. Blackmagic Duplicator 4K проверит все устройства в сети и самостоятельно выберет IP-адрес и другие сетевые параметры. Этот способ конфигурации является наиболее простым и надежным.

DHCP Off

Если вы предпочитаете ручную установку сетевых параметров, для настройки DHCP выберите опцию Off, затем задайте IP Address, Subnet Mask и Gateway.

IP Address, Subnet Mask и Gateway

Если настройка DHCP выключена, изменить эти параметры можно вручную.

Ввод значений

- 1 С помощью правой или левой кнопки многофункционального блока выберите поле, которое нужно изменить, и нажмите Change.
- 2 С помощью тех же кнопок измените значение параметра. Для ускорения настройки удерживайте кнопку в нажатом положении.
- 3 Нажмите кнопку SET, чтобы подтвердить сделанный выбор.

Таким же способом можно изменить значения остальных полей.



Меню Settings позволяет изменять настройки сетевых параметров, чтобы использовать приложение Telnet для дистанционного управления дубликатором

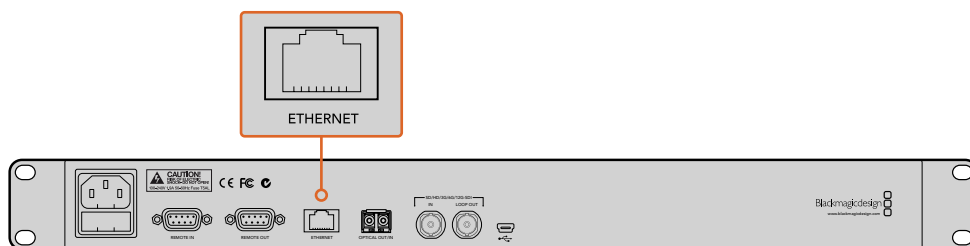

Подключите Blackmagic Duplicator 4K к локальной сети через порт Ethernet на задней панели

About

Меню About содержит информацию о текущем битрейте, имя последнего записанного файла, состояние сети и версию прошивки Blackmagic Duplicator 4K.

Blackmagic Duplicator Utility

Обновление прошивки Blackmagic Duplicator 4K

Обновление прошивки и изменение настройки File Name Prefix выполняются с помощью утилиты Blackmagic Duplicator Utility. Для оптимальной производительности рекомендуется использовать последнюю версию ПО.

Актуальная информация доступна в руководстве по эксплуатации, которое можно загрузить в центре поддержки Blackmagic Design на странице www.blackmagicdesign.com/support.

Порядок обновления внутреннего ПО на macOS

- 1 Загрузите и распакуйте Blackmagic Duplicator Utility.
- 2 Выберите соответствующий диск для просмотра его содержимого и запустите Blackmagic Duplicator Utility Installer. Следуйте инструкциям на экране.
- 3 После установки последней версии Blackmagic Duplicator Utility подключите Blackmagic Duplicator 4K к компьютеру через порт USB.
- 4 Запустите Duplicator Utility и откройте настройки, нажав на значок Settings. Утилита проверит прошивку Blackmagic Duplicator 4K и при наличии более поздней версии выведет сообщение "Update Now". Чтобы обновить внутреннее ПО, щелкните кнопкой мыши по значку. Если Blackmagic Duplicator 4K имеет актуальную версию, дополнительных действий не требуется.

Порядок обновления внутреннего ПО на Windows

- 1 Загрузите и распакуйте Blackmagic Duplicator Utility.
- 2 Найдите папку Blackmagic Duplicator Utility, в которой содержатся данное руководство и Blackmagic Duplicator Utility Installer. Щелкните кнопкой мыши дважды по значку установщика и следуйте инструкциям на экране.
- 3 После установки последней версии Blackmagic Duplicator Utility подключите Blackmagic Duplicator 4K к компьютеру через USB-порт.
- 4 Запустите Duplicator Utility и откройте настройки, нажав на значок Settings. Утилита проверит прошивку Blackmagic Duplicator 4K и при наличии более поздней версии выведет сообщение "Update Now". Чтобы обновить внутреннее ПО, щелкните кнопкой мыши по значку. Если Blackmagic Duplicator 4K имеет актуальную версию, дополнительных действий не требуется.

File Name Prefix

Чтобы облегчить идентификацию файлов, можно изменить их префикс. Нажмите кнопкой мыши на поле File Name Prefix и введите новое имя. При записи очередного клипа будет использоваться заданный префикс с четырехзначным числом, которое соответствует порядковому номеру и увеличивается на одно значение для каждого последующего клипа.

Чтобы файлы на всех объединенных в одну цепь дубликаторах записывались с одинаковым именем, нажмите кнопку дистанционного управления на ведомых устройствах, а затем измените префикс на главном устройстве. После этого клипы на всех SD-картах будут иметь одно имя файла.

Установка дополнительного оптического модуля

Для передачи SDI-сигнала по оптоволоконному кабелю необходимо использовать дополнительный модуль SFP (в соответствии со стандартами SMPTE), который можно приобрести у любого дилера компании Blackmagic Design. После установки в специальное гнездо на задней панели дубликатора этот модуль позволяет получать видео со встроенным звуком из SDI-источника, расположенного на большом расстоянии. Оптический выход также служит дополнительным сквозным портом.

При использовании оптоволоконных систем с невысокой скоростью передачи данных (3G-SDI или 6G-SDI) можно приобрести модуль соответствующей пропускной способности.

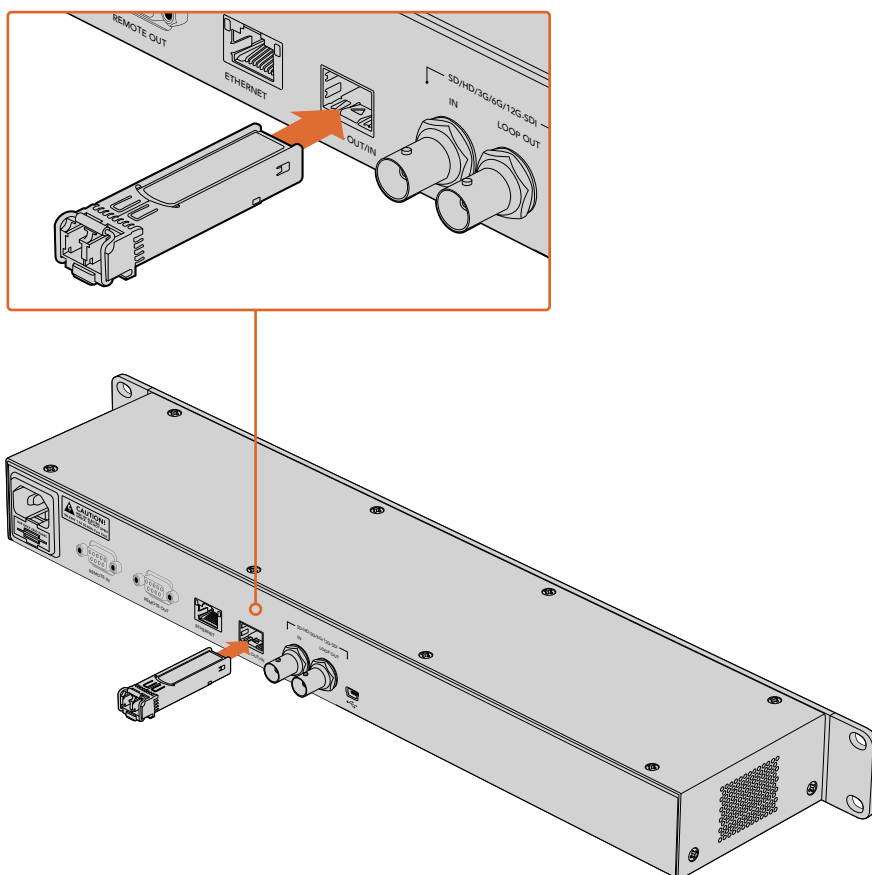

Дополнительный модуль дает возможность получать видео из SDI-источника по оптоволоконному кабелю

При одновременном наличии источников SDI- и оптического сигнала используется тот, который подключен первым. Для перехода между ними можно использовать настройку Video Source в экранном меню. Подробнее см. раздел «Настройки».

Управление по протоколу RS-422

Протокол RS-422

Протокол RS-422 является вещательным стандартом для управления через последовательный порт. Он применяется с начала 1980-х гг. и используется на многих деках, в приложениях линейного и нелинейного монтажа, а также в решениях для трансляции. Blackmagic Duplicator 4K поддерживает этот стандарт, поэтому устройство можно включить в систему автоматизации вещания, дистанционного контроля и программируемой записи видео.

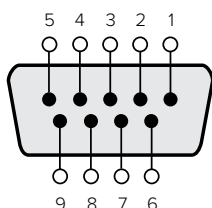

Передача (-)	Передача (+)	Прием (-)	Прием (+)	Контакты заземления
2	7	8	3	1, 4, 6, 9

Схема распиновки для дистанционного управления по протоколу RS-422

Использование внешнего контроллера RS-422

Blackmagic Duplicator 4K имеет стандартный порт REMOTE, который совместим с оборудованием Sony™ и позволяет напрямую подключаться к любому дистанционному контроллеру с поддержкой RS-422.

Можно использовать готовый 9-контактный кабель, если оба его конца полностью идентичны, т. е. выводы с одинаковым номером соединены друг с другом. При изготовлении собственного кабеля обратитесь к схеме распиновки на рисунке, чтобы правильно соединить контакты Tx (передача) с соответствующими контактами Rx (прием).

Если Blackmagic Duplicator 4K соединить с внешним контроллером RS-422, вместо локального управления можно использовать дистанционное.

- 5 Соедините с помощью кабеля RS-422 внешний контроллер и вход REMOTE IN на Blackmagic Duplicator 4K.
- 6 Нажмите кнопку REM на панели Blackmagic Duplicator 4K, чтобы активировать дистанционное управление.

Теперь запускать и останавливать обычную запись и в режиме Append можно удаленным способом. Полный перечень команд, поддерживаемых протоколом RS-422, см. в разделе ниже.

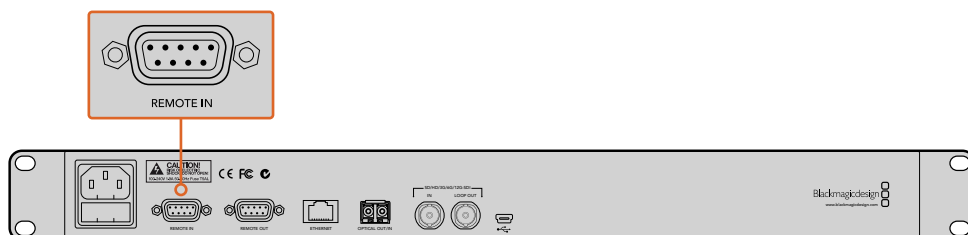

Для дистанционного управления подключите внешний контроллер ко входу REMOTE IN на Blackmagic Duplicator 4K

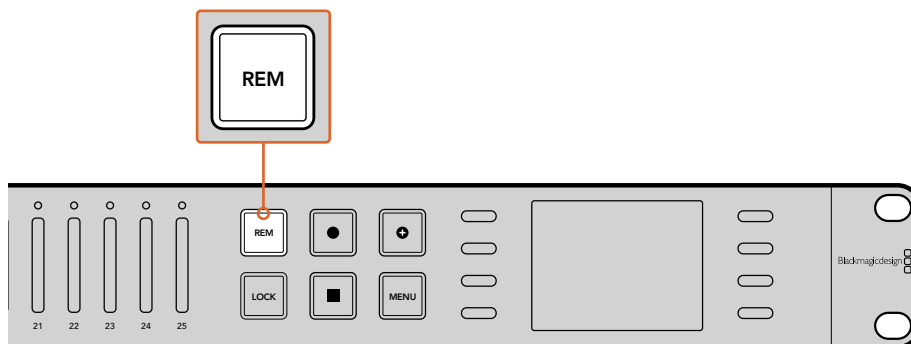

Нажмите кнопку REM на панели Blackmagic Duplicator 4K, чтобы активировать управление по протоколу RS-422

Supported RS-422 Commands

		Command	Reply	No Remote	Notes
0 - System Control					
0x00	0x11	DeviceTypeRequest	NTSC: 0xF0E0 PAL: 0xF1E0 24P: 0xF2E0	Enabled	–
1 - Slave Response					
0x20	0x00	Stop	Acknowledge	Disabled	–
0x20	0x02	Record	Acknowledge	Disabled	–
0x21	0x02	Append	Acknowledge	Disabled	Non-standard command - an extra payload of 0x00 indicates append
4 - Preset/Select Control					
0x40	0x40	AutoMode Off	Acknowledge	Disabled	ignored, Status bit remembered
0x40	0x41	AutoMode On	Acknowledge	Disabled	ignored, Status bit remembered
0x61	0x20	StatusSense	StatusData	Enabled	–
7 - Sense Reply					
0x70	0x20	StatusData	–	–	Please see “Status Bits” sheet: Limited to 9 bytes of status, silently truncated

RS-422 Developer Information

	Bit 7	Bit 6	Bit 5	Bit 4	Bit 3	Bit 2	Bit 1	Bit 0
Byte 0	0	0	Cassette out	0	0	0	0	Local
Byte 1	Standby	0	Stop	0	0	0	Record	0
Byte 2	0	0	0	0	0	0	0	0
Byte 3	Auto Mode	0	0	0	0	0	0	0
Byte 4	Select EE	Full EE	0	0	0	0	0	0
Byte 5	0	0	0	0	0	0	0	0
Byte 6	0	0	0	0	0	0	0	0
Byte 7	0	0	0	0	0	0	0	0
Byte 8	0	0	0	0	0	0	0	0
Byte 9	0	0	0	0	0	0	0	0

Variables	
Cassette Out	Set if no cards are ready to record
Local	Set if in local mode (no remote control)
Standby	Set if one or more cards are ready to record
Auto Mode	For compatibility only
Full EE	For compatibility only - always on
Select EE	For compatibility only - always on

Blackmagic Duplicator 4K RS-422 Settings	
Protocol	Based on Sony 9-pin protocol
Baud Rate	38.4 K
Start Bits	1
Data Bits	8
Stop Bits	1
Parity Bits	1
Parity Type	Odd

Дистанционное управление по сети Ethernet

Для внешнего управления дубликатором через сеть Ethernet можно использовать команды текстового протокола Blackmagic HyperDeck Ethernet Protocol. Он позволяет работать с Blackmagic Duplicator 4K в удаленном режиме с помощью установленного на компьютере приложения Telnet или создавать собственную аппаратную панель с функциями программирования.

Для управления дубликатором с компьютера, аппаратных панелей и крупных систем автоматизации на вещательных студиях и передвижных телестанциях можно использовать собственные решения. Например, микроконтроллеры Arduino допускают установку дополнительных плат расширения, оснащаемых разными разъемами. Для Blackmagic Duplicator 4K подойдет плата Ethernet Shield, в том числе с программируемыми кнопками. Микроконтроллеры Arduino просты в установке, доступны по цене и полностью совместимы с другой техникой. Чтобы приступить к работе, достаточно установить ПО Arduino и подключить микроконтроллер к Blackmagic Duplicator 4K через порт Ethernet.

Управление с помощью Arduino

Для программирования микроконтроллеров Arduino используется язык Си. Передача команд на Blackmagic Duplicator 4K выполняется с помощью протокола HyperDeck Ethernet Protocol. Список поддерживаемых команд содержится ниже в разделе "Blackmagic HyperDeck Ethernet Protocol".

Некоторые платы расширения для Arduino позволяют использовать дополнительные функции записи. Например, если добавить таймер, микроконтроллер будет запускать запись в определенное время дня. Такая возможность будет полезной при видеонаблюдении.

Технологии управления через Ethernet существенно облегчают работу и позволяют создавать собственные решения на основе внешних контроллеров.

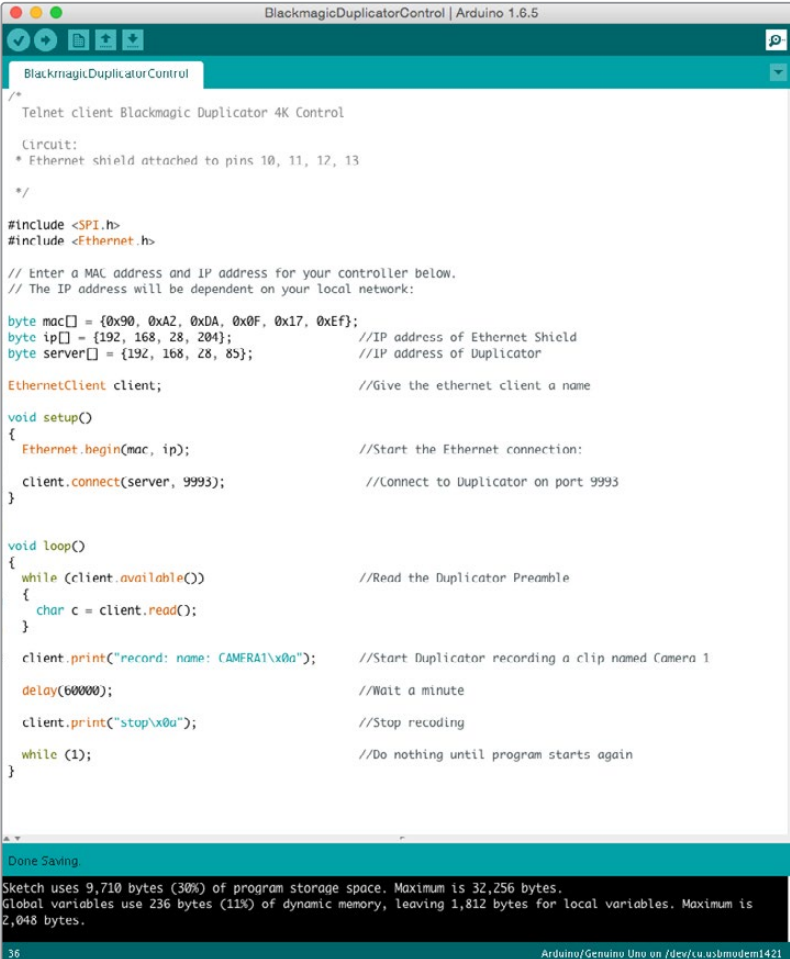

```
BlackmagicDuplicatorControl | Arduino 1.6.5
BlackmagicDuplicatorControl
/*
  Telnet client Blackmagic Duplicator 4K Control

  Circuit:
  * Ethernet shield attached to pins 10, 11, 12, 13
*/
#include <SPI.h>
#include <Ethernet.h>

// Enter a MAC address and IP address for your controller below.
// The IP address will be dependent on your local network:

byte mac[] = {0x90, 0xA2, 0xDA, 0x0F, 0x17, 0xEF};
byte ip[] = {192, 168, 28, 204}; //IP address of Ethernet Shield
byte server[] = {192, 168, 28, 85}; //IP address of Duplicator

EthernetClient client; //Give the ethernet client a name

void setup()
{
  Ethernet.begin(mac, ip); //Start the Ethernet connection:
  client.connect(server, 9993); //Connect to Duplicator on port 9993
}

void loop()
{
  while (client.available()) //Read the Duplicator Preamble
  {
    char c = client.read();
  }

  client.print("record: name: CAMFRA1\x0a"); //Start Duplicator recording a clip named Camera 1
  delay(60000); //Wait a minute
  client.print("stop\x0a"); //Stop recoding
  while (1); //Do nothing until program starts again
}

Done Saving
Sketch uses 9,710 bytes (30%) of program storage space. Maximum is 32,256 bytes.
Global variables use 236 bytes (11%) of dynamic memory, leaving 1,812 bytes for local variables. Maximum is 2,048 bytes.
36 Arduino/Genuino Uno on /dev/cu.usbmodem1421
```

При программировании микроконтроллера Arduino с платой расширения Ethernet Shield выберите нужные команды в соответствии с рисунком

Коды, показанные на рисунке выше, приведены на следующей странице, откуда их можно скопировать в программную среду Arduino IDE. С помощью этого кода Arduino передает на Blackmagic Duplicator 4K команду вести запись в течение одной минуты, затем остановить ее и ждать нового запуска.

```
/*
   Telnet client Blackmagic Duplicator 4K Control Circuit: *
Ethernet shield attached to pins 10, 11, 12, 13
*/
#include <SPI.h>
#include <Ethernet.h>

// Enter a MAC address and IP address for your controller below.
// The IP address will be dependent on your local network:
byte mac[] = {0x90, 0xA2, 0xDA, 0x0F, 0x17, 0xEF};
byte ip[] = {192, 168, 28, 204};          // IP address of
Ethernet Shield
byte server[] = {192, 168, 28, 141};     // IP address of Duplicator
EthernetClient client;                  // Give the ethernet
client a name

void setup()
{
  Ethernet.begin(mac, ip);    //Start the Ethernet connection:

  client.connect(server, 9993);    //Connect to Duplicator on port 9993
}

void loop()
{
  while (client.available()) //Read the Duplicator Preamble
  {
    char c = client.read();
  }

  client.print("record: name: Cameral\x0a");
  //Start Duplicator recording a clip named Camera 1
  delay(60000);          //Wait a minute
  client.print("stop\x0a");    //Stop recoding
  while (1);            //Do nothing until program
  starts again
}
```

Blackmagic HyperDeck Ethernet Protocol

Blackmagic HyperDeck Ethernet Protocol — текстовый протокол, изначально созданный для управления дисковыми рекордерами Blackmagic HyperDeck через порт Ethernet. В настоящее время его также можно использовать для работы с Blackmagic Duplicator 4K.

Поскольку дубликатор способен только вести запись, он не поддерживает все возможные команды протокола. Этот раздел содержит перечень команд, которые применимы для Blackmagic Duplicator 4K.

Protocol Commands

Command	Command Description
help or ?	Provides help text with all commands and parameters.
remote	Queries the state of HyperDeck's remote control mode.
remote: enable: true	Enables remote control.
remote: enable: false	Disables remote control.
remote: override: true	Turns remote override on.
remote: override: false	Turns remote override off.
quit	Disconnects HyperDeck server.
ping	Determines HyperDeck server is responding.
record	Starts recording.
record: append: true	Starts appended recording.
stop	Stops playback or recording.
commands	Lists all supported commands in an XML format.
notify	Queries the current state of all notifications.
notify: transport: true	Enables transport notifications.
notify: transport: false	Disables transport notifications.
notify: slot: true	Enables slot notifications.
notify: slot: false	Disables slot notifications.
notify: remote: true	Enables remote notifications.
notify: remote: false	Disables remote notifications.
notify: configuration: true	Enables configuration notifications.
notify: configuration: false	Disables configuration notifications.
notify: dropped frames: true	Enables dropped frames notifications.
notify: dropped frames: false	Disables dropped frames notifications.
device info	Provides device information.
slot info: slot id: {slot ID}	Provides information about a specified slot.
transport info	Provides information for the state of the transport.
configuration	Queries the current configuration.
configuration: record mode: Duplicate	Configures the record mode to duplicate.

Command	Command Description
configuration: record mode: SingleDisk	Configures the record mode to single disk.
configuration: record mode: DiskOverwrite	Configures the record mode to disk overwrite.
configuration: video input: {"SDI", "optical"}	Configures video input.
configuration: file format: {format}	Configures the record codec and bit rate.
format: prepare: {format}	prepare a disk formatting operation to filesystem {format}
format: confirm: {token}	perform a pre-prepared formatting operation using token
watchdog: period: {seconds}	Configures the watchdog.

Using XML

While you can use the Terminal to talk to HyperDeck, if you are writing software you can use XML to confirm the existence of a specific command based on the firmware of the HyperDeck you are communicating with. This helps your software user interface adjust to the capabilities of the specific HyperDeck model and software version.

Protocol Details

Connection

The HyperDeck Ethernet server listens on TCP port 9993.

Basic syntax

The HyperDeck protocol is a line oriented text protocol. Lines from the server will be separated by an ASCII CR LF sequence. Messages from the client may be separated by LF or CR LF.

New lines are represented in this document as a "↵" symbol.

Command syntax

Command parameters are usually optional. A command with no parameters is terminated with a new line:

```
{Command name}↵
```

If parameters are specified, the command name is followed by a colon, then pairs of parameter names and values. Each parameter name is terminated with a colon character:

```
{Command name}: {Parameter}: {Value} {Parameter}: {Value} ...↵
```

Response syntax

Simple responses from the server consist of a three digit response code and descriptive text terminated by a new line:

```
{Response code} {Response text}↵
```

If a response carries parameters, the response text is terminated with a colon, and parameter name and value pairs follow on subsequent lines until a blank line is returned:

```
{Response code} {Response text}:↵
{Parameter}: {Value}↵
{Parameter}: {Value}↵
...
↵
```

Successful response codes

A simple acknowledgement of a command is indicated with a response code of 200:

```
200 ok↵
```

Other successful responses carry parameters and are indicated with response codes in the range of 201 to 299.

Failure response codes

Failure responses to commands are indicated with response codes in the range of 100 to 199:

```
100 syntax error
101 unsupported parameter
102 invalid value
103 unsupported
104 disk full
105 no disk
106 disk error
109 out of range
110 no input
111 remote control disabled
120 connection rejected
150 invalid state
```

Asynchronous response codes

The server may return asynchronous messages at any time. These responses are indicated with response codes in the range of 500 to 599:

```
5xx {Response Text}:↵
{Parameter}: {Value}↵
{Parameter}: {Value}↵
↵
```

Connection response

On connection, an asynchronous message will be delivered:

```
500 connection info:↵
protocol version: {Version}↵
model: {Model Name}↵
↵
```

Connection rejection

Only one client may connect to the server at a time. If other clients attempt to connect concurrently, they will receive an error and be disconnected:

```
120 connection rejected↵
```

Timecode syntax

Timecodes are expressed as non-drop-frame timecode in the format:

```
HH:MM:SS:FF
```

Handling of deck "remote" state

The "remote" command may be used to enable or disable the remote control of the deck. Any attempt to change the deck state over ethernet while remote access is disabled will generate an error:

```
111 remote control disabled↵
```

To enable or disable remote control:

```
remote: enable: {"true", "false"} ↵
```

The current remote control state may be overridden allowing remote access over ethernet irrespective of the current remote control state:

```
remote: override: {"true", "false"} ↵
```

The override state is only valid for the currently connected ethernet client and only while the connection remains open.

The "remote" command may be used to query the remote control state of the deck by specifying no parameters:

```
remote↵
```

The deck will return the current remote control state:

```
210 remote info:↵
enabled: {"true", "false"}↵
override: {"true", "false"}↵
↵
```

Asynchronous remote control information change notification is disabled by default and may be configured with the "notify" command. When enabled, changes in remote state will generate a "510 remote info:" asynchronous message with the same parameters as the "210 remote info:" message.

Closing connection

The "quit" command instructs the server to cleanly shut down the connection:

```
quit↵
```

Checking connection status

The "ping" command has no function other than to determine if the server is responding:

```
ping↵
```

Getting help

The "help" or "?" commands return human readable help text describing all available commands and parameters:

```
help↵
```

or:

```
?↵
```

The server will respond with a list of all supported commands:

```
201 help:↵
{Help Text}↵
{Help Text}↵
↵
```

Stopping deck operation

The "stop" command instructs the deck to stop the current capture:

```
stop↵
```

Enumerating supported commands and parameters

The "commands" command returns the supported commands:

```
commands↵
```

The command list is returned in a computer readable XML format:

```
212 commands:
<commands>↵
    <command name="..."><parameter name="...">...</command>↵
    <command name="..."><parameter name="...">...</command>↵
    ...
</commands>↵
↵
```

More XML tokens and parameters may be added in later releases.

Controlling asynchronous notifications

The "notify" command may be used to enable or disable asynchronous notifications from the server. To enable or disable transport notifications:

```
notify: transport: {"true", "false"}↵
```

To enable or disable slot notifications:

```
notify: slot: {"true", "false"}↵
```

To enable or disable remote notifications:

```
notify: remote: {"true", "false"}↵
```

To enable or disable configuration notifications:

```
notify: configuration: {"true", "false"}↵
```

To enable or disable dropped frames notifications:

```
notify: dropped frames: {"true", "false"}↵
```

Multiple parameters may be specified. If no parameters are specified, the server returns the current state of all notifications:

```
209 notify:↵
transport: {"true", "false"}↵
slot: {"true", "false"}↵
remote: {"true", "false"}↵
configuration: {"true", "false"}↵
↵
```

Retrieving device information

The "device info" command returns information about the connected deck device:

```
device info↵
```

The server will respond with:

```
204 device info:↵
protocol version: {Version}↵
model: {Model Name}↵
unique id: {unique alphanumeric identifier}↵
↵
```

Example of response from server:

```
204 device info:↵
protocol version: 1.8↵
model: Blackmagic Duplicator 4K↵
unique id: 101112131415↵
↵
```

Retrieving slot information

The "slot info" command returns information about a slot.

The specified slot will be queried:

```
slot info: slot id: {Slot ID}↵
```

The server will respond with slot specific information:

```
202 slot info:↵
slot id: {Slot ID}↵
status: {"empty", "mounting", "error", "mounted"}↵
volume name: {Volume name}↵
recording time: {recording time available in seconds}↵
video format: {disk's default video format}↵
↵
```

Asynchronous slot information change notification is disabled by default and may be configured with the “notify” command. When enabled, changes in slot state will generate a “502 slot info:” asynchronous message with the same parameters as the “202 slot info:” message.

Retrieving transport information

The “transport info” command returns the state of the transport:

```
transport info ↵
```

The server responds with transport specific information:

```
208 transport info:↵  
status: {"stopped","record"}↵  
display timecode: {timecode}↵  
timecode: {timecode}↵
```

The “timecode” value is the timecode within the current timeline for playback or the clip for record. The “display timecode” is the timecode displayed on the front of the deck. The two timecodes will differ in some deck modes.

Asynchronous transport information change notification is disabled by default and may be configured with the “notify” command. When enabled, changes in transport state will generate a “508 transport info:” asynchronous message with the same parameters as the “208 transport info:” message.

Video Formats

The following video formats are currently supported on Blackmagic Duplicator 4K:

SD

525i59.94 NTSC
625i50 PAL

HD

720p50	1080p30
720p59.94	1080i50
720p60	1080p50
1080p23.98	1080i59.94
1080p24	1080p59.94
1080p25	1080i60
1080p29.97	1080p60

Ultra HD

2160p23.98	2160p30
2160p24	2160p50
2160p25	2160p59.94
2160p29.97	2160p60

Duplicator 4K supports progressive segmented frame modes, and automatically detects level A and level B 3G-SDI formats for 1080p50, 1080p59.94 and 1080p60.

File Formats

Duplicator 4K supports the following file formats:

- H.264Low
- H.264Medium
- H.264High
- H.265Low
- H.265Medium
- H.265High

Querying and updating configuration information

The "configuration" command may be used to query the current configuration of the deck:

```
configuration↵
```

The server returns the configuration of the deck:

```
211 configuration:↵  
video input: {"SDI", "optical"}↵  
↵
```

One or more configuration parameters may be specified to change the configuration of the deck.

To change the current video input:

```
configuration: video input: {"SDI", "optical"}↵
```

Configuring the watchdog

The "watchdog" command instructs the deck to monitor the connected client and terminate the connection if the client is inactive for at least a specified period of time.

To configure the watchdog:

```
watchdog: period: {period in seconds}↵
```

To avoid disconnection, the client must send a command to the server at least every {period} seconds. Note that if the period is set to 0 or less than 0, connection monitoring will be disabled.

Configuring the record mode

Use the 'record mode' command to select the deck recording mode:

```
configuration: record mode: {"Duplicate", "SingleDisk", "DiskOverwrite"}↵
```

Configuring the file format

The 'file format' command instructs the deck to switch to a specific file format for codec and bit rate:

```
configuration: file format: {"H.264High", "H.264Medium", "H.264Low",  
"H.265High", "H.265Medium", "H.265Low"}↵
```

Помощь

Как получить помощь

Самый быстрый способ получить помощь — обратиться к страницам поддержки на сайте Blackmagic Design и проверить наличие последних справочных материалов по Blackmagic Duplicator 4K.

Страница поддержки на сайте Blackmagic Design

Последние версии руководства по эксплуатации, программного обеспечения и дополнительную информацию можно найти в центре поддержки Blackmagic Design на странице www.blackmagicdesign.com/support.

Форум сообщества Blackmagic Design

Полезным источником информации является форум сообщества на веб-сайте Blackmagic Design. На нем можно поделиться своими идеями, а также получить помощь от персонала поддержки и других пользователей. Адрес форума <http://forum.blackmagicdesign.com>.

Обращение в Службу поддержки Blackmagic Design

Если с помощью доступных справочных материалов и форума решить проблему не удалось, воспользуйтесь формой «Отправить нам сообщение» на странице поддержки. Можно также позвонить в ближайшее представительство Blackmagic Design, телефон которого вы найдете на нашем веб-сайте.

Проверка используемой версии программного обеспечения

Чтобы узнать версию Blackmagic Duplicator Utility, установленную на вашем компьютере, откройте окно About Blackmagic Duplicator Utility.

- На компьютере с операционной системой macOS откройте Blackmagic Duplicator Utility в папке «Приложения». В меню выберите About Blackmagic Duplicator Utility, чтобы узнать номер версии.
- На компьютере с операционной системой Windows 8.1 выберите Blackmagic Duplicator Utility на экране «Пуск». В меню «Помощь» выберите About Blackmagic Duplicator Utility, чтобы узнать номер версии.
- На компьютере с операционной системой Windows 10 откройте Blackmagic Duplicator Utility в меню «Пуск». В меню «Помощь» выберите About Blackmagic Duplicator Utility, чтобы узнать номер версии.

Загрузка последних версий программного обеспечения

Узнав установленную версию Blackmagic Duplicator Utility, перейдите в центр поддержки Blackmagic на странице www.blackmagicdesign.com/support, чтобы проверить наличие обновлений. Рекомендуется всегда использовать последнюю версию программного обеспечения, однако обновление лучше всего выполнять после завершения текущего проекта.

Соблюдение нормативных требований

Утилизация электрооборудования и электронной аппаратуры в Европейском Союзе



Изделие содержит маркировку, в соответствии с которой его запрещается утилизировать вместе с бытовыми отходами. Непригодное для эксплуатации оборудование необходимо передать в пункт вторичной переработки. Раздельный сбор отходов и их повторное использование позволяют беречь природные ресурсы, охранять окружающую среду и защищать здоровье человека. Чтобы получить подробную информацию о порядке утилизации, обратитесь в местные муниципальные органы или к дилеру, у которого вы приобрели это изделие.



Данное оборудование протестировано по требованиям для цифровых устройств класса А (раздел 15 спецификаций FCC) и признано соответствующим всем предъявляемым критериям. Соблюдение упомянутых нормативов обеспечивает достаточную защиту от вредного излучения при работе оборудования в нежилых помещениях. Так как это изделие генерирует и излучает радиоволны, при неправильной установке оно может становиться источником радиопомех. Если оборудование эксплуатируется в жилых помещениях, высока вероятность возникновения помех, влияние которых в этом случае пользователь должен устранить самостоятельно.

До эксплуатации допускаются устройства, соответствующие двум главным требованиям.

- 1 Оборудование не должно быть источником вредных помех.
- 2 Оборудование должно быть устойчивым к помехам, включая помехи, которые могут вызвать сбой в работе.

Соответствие требованиям ISED (Канада)

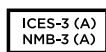

Данное оборудование соответствует канадским стандартам для цифровых устройств класса А.

Любая модификация или использование изделия не по назначению могут повлечь за собой аннулирование заявления о соответствии этим стандартам.

Данное оборудование протестировано по требованиям, предъявляемым к устройствам при работе в нежилых помещениях. При использовании в бытовых условиях оно может становиться источником помех для радиосигнала.

Правила безопасности

Во избежание удара электрическим током розетка для подключения устройства к сети должна иметь заземляющий контакт. При необходимости обратитесь за помощью к квалифицированному электрику.

Чтобы минимизировать опасность поражения электрическим током, изделие необходимо защищать от попадания брызг и капель воды.

Допускается его эксплуатация в условиях тропического климата с температурой окружающей среды до 40°C.

Для работы устройства необходимо обеспечить достаточную вентиляцию.

При установке в стойку убедитесь в том, что не нарушен приток воздуха.

Внутри корпуса не содержатся детали, подлежащие обслуживанию. Для выполнения ремонтных работ обратитесь в местный сервисный центр Blackmagic Design.

Ряд оборудования позволяет установить компактный оптический SFP-модуль. Используйте только модули типа Laser class 1.

Рекомендуемые типы SFP-модулей

- **3G-SDI:** PL-4F20-311C
- **6G-SDI:** PL-8F10-311C
- **12G-SDI:** PL-TG10-311C



Допускается эксплуатация в местах не выше 2000 метров над уровнем моря.

Уведомление для жителей штата Калифорния

При работе с этим оборудованием существует возможность контакта с химическими соединениями, включая шестивалентный хром, который в штате Калифорния признан канцерогеном и увеличивает риск врожденных дефектов и пороков репродуктивной системы.

Подробнее см. информацию на сайте www.P65Warnings.ca.gov.

Предупреждение для технического персонала



Осторожно: плавкий предохранитель двухполюсный/в нейтрали

Блок питания в этом устройстве имеет предохранитель в линейном и нейтральном проводах и подходит для подключения к системе энергоснабжения типа IT в Норвегии.

Гарантия

Ограниченная гарантия сроком 12 месяцев

Компания Blackmagic Design гарантирует отсутствие в данном изделии дефектов материала и производственного брака в течение 12 месяцев с даты продажи. Если во время гарантийного срока будут выявлены дефекты, Blackmagic Design по своему усмотрению выполнит ремонт неисправного изделия без оплаты стоимости запчастей и трудозатрат или заменит такое изделие новым.

Чтобы воспользоваться настоящей гарантией, потребитель обязан уведомить компанию Blackmagic Design о дефекте до окончания гарантийного срока и обеспечить условия для предоставления необходимых услуг. Потребитель несет ответственность за упаковку и доставку неисправного изделия в соответствующий сервисный центр Blackmagic Design с оплатой почтовых расходов. Потребитель обязан оплатить все расходы по доставке и страхованию, пошлины, налоги и иные сборы в связи с возвратом изделия вне зависимости от причины возврата.

Настоящая гарантия не распространяется на дефекты, отказы и повреждения, возникшие из-за ненадлежащего использования, неправильного ухода или обслуживания. Компания Blackmagic Design не обязана предоставлять услуги по настоящей гарантии: а) для устранения повреждений, возникших в результате действий по установке, ремонту или обслуживанию изделия лицами, которые не являются персоналом Blackmagic Design; б) для устранения повреждений, возникших в результате ненадлежащего использования или подключения к несовместимому оборудованию; в) для устранения повреждений или дефектов, вызванных использованием запчастей или материалов других производителей; г) если изделие было модифицировано или интегрировано с другим оборудованием, когда такая модификация или интеграция увеличивает время или повышает сложность обслуживания изделия. **НАСТОЯЩАЯ ГАРАНТИЯ ПРЕДОСТАВЛЯЕТСЯ КОМПАНИЕЙ BLACKMAGIC DESIGN ВМЕСТО ЛЮБЫХ ДРУГИХ ПРЯМО ВЫРАЖЕННЫХ ИЛИ ПОДРАЗУМЕВАЕМЫХ ГАРАНТИЙ. КОМПАНИЯ BLACKMAGIC DESIGN И ЕЕ ДИЛЕРЫ ОТКАЗЫВАЮТСЯ ОТ ЛЮБЫХ ПОДРАЗУМЕВАЕМЫХ ГАРАНТИЙ КОММЕРЧЕСКОЙ ЦЕННОСТИ ИЛИ ПРИГОДНОСТИ ДЛЯ КАКОЙ-ЛИБО ОПРЕДЕЛЕННОЙ ЦЕЛИ. ОТВЕТСТВЕННОСТЬ BLACKMAGIC DESIGN ПО РЕМОНТУ ИЛИ ЗАМЕНЕ НЕИСПРАВНЫХ ИЗДЕЛИЙ ЯВЛЯЕТСЯ ПОЛНЫМ И ИСКЛЮЧИТЕЛЬНЫМ СРЕДСТВОМ ВОЗМЕЩЕНИЯ, ПРЕДОСТАВЛЯЕМЫМ ПОТРЕБИТЕЛЮ В СВЯЗИ С КОСВЕННЫМИ, ФАКТИЧЕСКИМИ, СОПУТСТВУЮЩИМИ ИЛИ ПОСЛЕДУЮЩИМИ УБЫТКАМИ, ВНЕ ЗАВИСИМОСТИ ОТ ТОГО, БЫЛА ИЛИ НЕТ КОМПАНИЯ BLACKMAGIC DESIGN (ЛИБО ЕЕ ДИЛЕР) ПРЕДВАРИТЕЛЬНО ИЗВЕЩЕНА О ВОЗМОЖНОСТИ ТАКИХ УБЫТКОВ. BLACKMAGIC DESIGN НЕ НЕСЕТ ОТВЕТСТВЕННОСТИ ЗА ПРОТИВОПРАВНОЕ ИСПОЛЬЗОВАНИЕ ОБОРУДОВАНИЯ СО СТОРОНЫ ПОТРЕБИТЕЛЯ. BLACKMAGIC DESIGN НЕ НЕСЕТ ОТВЕТСТВЕННОСТИ ЗА УБЫТКИ, ВОЗНИКАЮЩИЕ ВСЛЕДСТВИЕ ИСПОЛЬЗОВАНИЯ ЭТОГО ИЗДЕЛИЯ. РИСКИ, СВЯЗАННЫЕ С ЕГО ЭКСПЛУАТАЦИЕЙ, ВОЗЛАГАЮТСЯ НА ПОТРЕБИТЕЛЯ.**

© Copyright 2019 Blackmagic Design. Все права защищены. Blackmagic Design, DeckLink, HDLink, Workgroup Videohub, Videohub, DeckLink, Intensity и "Leading the creative video revolution" зарегистрированы как товарные знаки в США и других странах. Названия других компаний и наименования продуктов могут являться товарными знаками соответствующих правообладателей. Технология Thunderbolt и логотип Thunderbolt являются товарными знаками корпорации Intel в США и других странах.

Blackmagicdesign



Manuale di istruzioni

Blackmagic Duplicator 4K

Febbraio 2019

Italiano



Benvenuto e Benvenuta,

Grazie per aver acquistato Blackmagic Duplicator 4K.

Siamo felicissimi di presentare Blackmagic Duplicator 4K, la soluzione ideale per la distribuzione immediata al pubblico di contenuti Ultra HD di altissima qualità. Il duplicatore registra contemporaneamente su 25 schede SD, nei formati SD, HD e Ultra HD fino al 2160p60 con la compressione standard in H.264 o la più evoluta H.265. Ne risultano immagini di alta qualità dai frame rate elevati ma a bassa velocità di trasferimento, consentendo di eseguire registrazioni di lunga durata su schede economiche.

Blackmagic Duplicator 4K offre controlli intuitivi ed è facilissimo da installare. Il pannello frontale ospita un display LCD e pulsanti per cambiare le impostazioni e operare il dispositivo con facilità. Inoltre la connessione RS-422 consente di gestire il duplicatore in modalità remota tramite ethernet o un dispositivo di controllo RS-422. E grazie al Blackmagic HyperDeck Ethernet Protocol, è possibile creare una soluzione di controllo su misura.

Il codificatore H.265 in tempo reale integrato registra file video di altissima qualità su schede SD economiche in formati fino all'Ultra HD 2160p60, senza ricorrere alle schede più veloci. E ora l'ultima versione del software, Blackmagic Duplicator 4K 1.2, offre anche la compressione in H.264 per una maggiore compatibilità!

Blackmagic Duplicator 4K ha un profilo di una unità di rack che facilita l'interconnessione di più unità su un sistema a rack mobile, per registrare su centinaia di schede SD contemporaneamente.

Il manuale di istruzioni contiene tutte le informazioni utili per installare e utilizzare Blackmagic Duplicator 4K.

La versione più recente di questo manuale e gli aggiornamenti del software Blackmagic Duplicator 4K sono disponibili sulla pagina di supporto del nostro sito www.blackmagicdesign.com/it. È importante aggiornare regolarmente il software per disporre delle ultime funzioni. Una volta scaricato il software, registra i tuoi dati personali per ricevere le notifiche sugli aggiornamenti futuri. Blackmagic è in costante stato di innovazione. Ti invitiamo a lasciare i tuoi preziosi suggerimenti per consentirci di migliorare prestazioni e funzionalità.

A stylized, cursive signature in black ink that reads "Grant Petty".

Grant Petty

AD di Blackmagic Design

Indice

Blackmagic Duplicator 4K

Operazioni preliminari	302
Collegare l'alimentazione	302
Collegare le fonti video e audio	302
Interconnessione	303
Inserire e formattare le schede SD	304
Registrazione	305
Impostare la modalità di registrazione	305
Impostare il codec	306
Impostare il bitrate	307
Registrazione contenuti	308
Spie LED di stato	308
Registrazione Append	309
Bloccare Blackmagic Duplicator 4K	310
Interconnettere più unità Blackmagic Duplicator 4K	310
Menù impostazioni del display LCD	312
Record	312
Impostazioni	317
About	318
Blackmagic Duplicator Utility	318
Aggiornare Blackmagic Duplicator 4K	318
Prefisso del file	318
Installare il modulo opzionale Optical Fiber SDI Module	319
Protocollo RS-422	320
Cos'è il protocollo RS-422?	320
Utilizzare un dispositivo di controllo esterno RS-422	320
RS-422 Developer Information	322
Controllo remoto tramite ethernet	322
Un esempio di controllo tramite Arduino	323
Blackmagic HyperDeck Ethernet Protocol	325
Protocol Commands	325
Protocol Details	326
Configuring the watchdog	331
Configuring the record mode	331
Configuring the file format	331
Assistenza	332
Normative	333
Sicurezza	334
Garanzia	335

Operazioni preliminari

Configurare Blackmagic Duplicator 4K è facile.

Basta collegare l'alimentazione, connettere la fonte video SDI e inserire il numero desiderato di schede SD. Per registrare su più di 25 schede, interconnetti un altro Blackmagic Duplicator 4K sfruttando le connessioni video e di controllo. Questa sezione del manuale spiega come configurare Blackmagic Duplicator 4K ed iniziare subito a registrare su 25 schede SD contemporaneamente.

Collegare l'alimentazione

Per alimentare Blackmagic Duplicator 4K, collega il cavo IEC standard all'ingresso 110-240V sul retro del pannello.

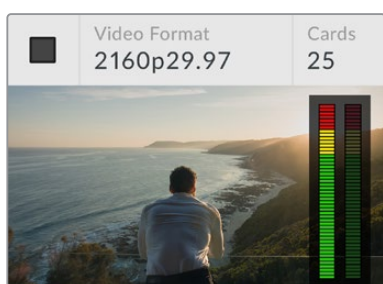

All'accensione il display LCD mostra la schermata iniziale.

Schermata iniziale

La schermata iniziale mostra l'immagine della fonte video e le informazioni ad essa relative tra cui il formato, il numero delle schede SD inserite, una spia di stato che segnala la registrazione in corso e gli indicatori di livello audio.

Collegare le fonti video e audio

Collega la fonte video all'ingresso 12G-SDI sul retro del pannello. Blackmagic Duplicator 4K rileva automaticamente il formato di entrata e lo mostra sulla schermata iniziale del display LCD.

L'ingresso SDI e i connettori BNC sono compatibili con i segnali video 12G-SDI, consentendo la connessione di fonti SD, HD o Ultra HD fino al 2160p60 tramite un singolo cavo BNC. Pertanto l'uscita di loop è sempre conforme al formato della fonte video in entrata, permettendo di inviare lo stesso segnale agli altri dispositivi video SDI e di interconnettere più Blackmagic Duplicator 4K. Inoltre supporta le modalità PsF, e rileva automaticamente i formati 3G-SDI di livello A e B a 1080p50, 1080p59.94, e 1080p60.

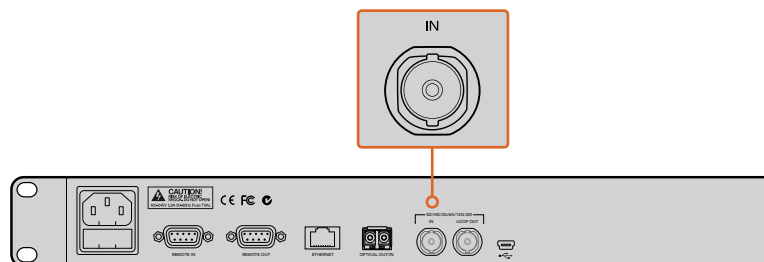

Collega la fonte video al connettore SDI sul retro. L'audio è integrato nel segnale video SDI.

Poiché Blackmagic Duplicator 4K ammette 2 canali di audio SDI integrato, non è necessario collegare l'audio perché è già presente nell'ingresso video SDI.

SUGGERIMENTO Fai il monitoraggio dei livelli audio della fonte video direttamente sul display LCD.

Interconnessione

Per registrare su più di 25 schede SD è possibile interconnettere più Blackmagic Duplicator 4K. Per esempio, per duplicare 100 schede basta connettere 4 unità.

- 1 Connetti l'uscita RS-422 REMOTE OUT del primo Blackmagic Duplicator 4K all'ingresso REMOTE IN del secondo. Segui lo stesso procedimento per ogni unità periferica.
- 2 Analogamente, connetti l'uscita di loop SDI della prima unità all'ingresso SDI della seconda, e segui lo stesso procedimento per ogni unità periferica.
- 3 Sul pannello di controllo di ogni unità c'è un pulsante chiamato REM. Premi questo pulsante per abilitare il controllo remoto di tutti i Blackmagic Duplicator 4K interconnessi.

NOTA Assicurati che il pulsante REM sul primo Blackmagic Duplicator 4K sia disattivato, poiché questo dispositivo controlla tutte le altre unità periferiche interconnesse. Disattivando la funzione REM sulla unità di controllo, qualsiasi comando selezionato verrà impartito alle unità periferiche su cui la funzione REM è attivata.

Così facendo i comandi selezionati sull'unità di controllo vengono automaticamente impartiti a tutte le altre.

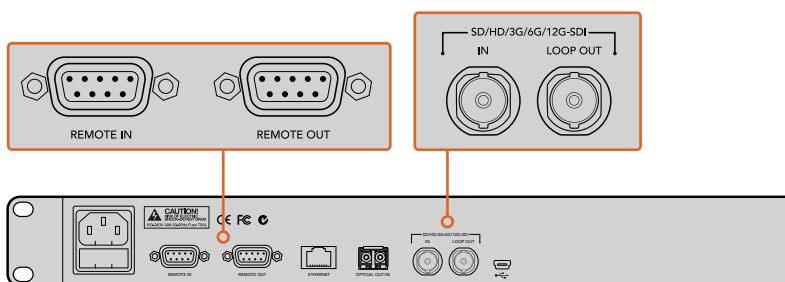

I connettori REMOTE e LOOP consentono di interconnettere più Blackmagic Duplicator 4K. Il connettore LOOP dell'ultima unità si può utilizzare per ritrasmettere la fonte video ad altri dispositivi SDI, per esempio al Blackmagic SmartView o al registratore su disco HyperDeck.

Per tutti i dettagli su come interconnettere più unità, consulta la sezione "Interconnettere più unità Blackmagic Duplicator 4K".

Inserire e formattare le schede SD

Blackmagic Duplicator 4K si avvale delle comuni schede SD di Classe 10. Le schede SD di Classe 10 sono disponibili nei punti vendita di prodotti per videocamere, e in alcuni supermercati.

SUGGERIMENTO Sull'etichetta delle schede SD troverai un piccolo cerchio con un numero da 1 a 10. La numerazione rappresenta la velocità di trasferimento, in ordine crescente. Le schede con un cerchio 10 sono di Classe 10, ideali per registrare nel più alto frame rate dell'Ultra HD.

Inserire la scheda SD:

- 1 Allinea la scheda allo slot con i connettori dorati rivolti verso il display LCD di Blackmagic Duplicator 4K.
- 2 Inserisci con cautela la scheda nello slot fino a bloccarla in posizione. Blackmagic Duplicator 4K legge la scheda, e la spia LED sopra lo slot diventa verde quando è pronta alla registrazione.

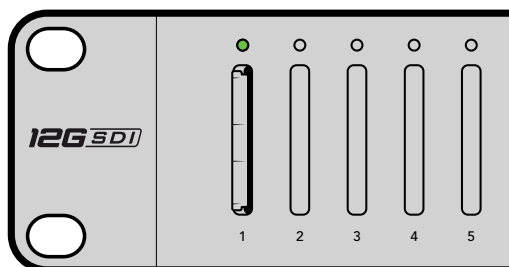
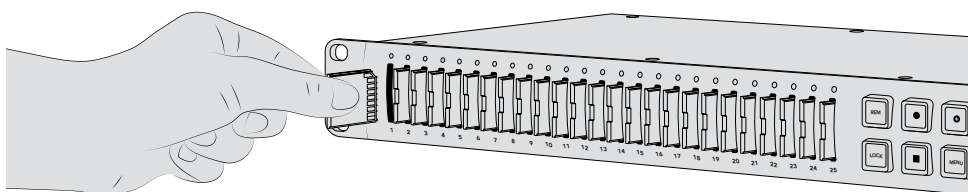

Allinea la scheda allo slot con i connettori dorati rivolti verso il display LCD e inseriscila con cautela nello slot fino a bloccarla in posizione. La spia LED sopra lo slot diventa verde quando è pronta alla registrazione.

Per rimuovere la scheda, estrarla delicatamente dallo slot.

SUGGERIMENTO Prima di inserire la scheda, sposta la linguetta di protezione sovrascrizione verso sinistra, vicino ai connettori. Ora è possibile registrare sulla scheda. Una volta completata la registrazione, sposta la linguetta di protezione verso destra per evitare la sovrascrizione.

Formattare le schede SD

Prima di iniziare a registrare è necessario formattare le schede SD nel formato exFAT. Questo formato è compatibile con i computer macOS e Windows. La funzione "Format" di Blackmagic Duplicator 4K consente di formattare fino a 25 schede SD contemporaneamente su una singola unità.

Per formattare le schede SD con Blackmagic Duplicator 4K:

- 1 Premi il pulsante MENU sul pannello di controllo.
- 2 Utilizzando i pulsanti contestuali luminosi su entrambi i lati del display LCD, seleziona "Record".
- 3 Premi il pulsante a sinistra per selezionare la voce "Format Cards", poi premi il pulsante corrispondente alla voce "Format" in basso a destra del menù.
- 4 Un messaggio chiederà di confermare il formato selezionato. Premi il pulsante contestuale corrispondente alla voce Format per confermare, oppure premi "Cancel" per annullare.
- 5 Una barra di avanzamento mostra lo stato della formattazione in corso. Quando la formattazione è completata, premi "OK".
- 6 Premi il pulsante MENU sul pannello di controllo per tornare alla schermata principale.

Premi il pulsante MENU sul pannello di controllo per tornare alla schermata principale.

Una volta connesse le fonti video e audio e completata la formattazione delle schede, puoi iniziare a registrare.

SUGGERIMENTO Esistono molti tipi di schede SD a seconda della capienza e della velocità di scrittura, pertanto i tempi di formattazione variano da scheda a scheda.

Registrazione

Per registrare basta premere il pulsante di registrazione sul pannello di controllo frontale. Consigliamo di iniziare impostando la modalità di registrazione, il codec e il bitrate perché questi valori definiscono il tipo, la durata e la qualità della registrazione.

Impostare la modalità di registrazione

Blackmagic Duplicator 4K offre vari tipi di registrazione:

- **"Duplicate"**: registra su tutte le schede SD contemporaneamente.
- **"Single Disk"**: registra su una scheda SD alla volta, e termina la registrazione quando l'ultima scheda è piena.
- **"Single Disk Overwrite"**: registra su una scheda SD alla volta, e continua la registrazione in loop continuo.

Modalità Duplicate

Blackmagic Duplicator 4K registra su tutte le schede SD contemporaneamente.

Modalità Single Disk

Blackmagic Duplicator 4K comincia la registrazione su una scheda SD, e continua su quella successiva, fino a quando tutte le schede sono piene. È ideale per le registrazioni di log con

numerose applicazioni per la trasmissione televisiva o per le telecamere di sicurezza. Con 25 slot disponibili, puoi registrare senza interruzioni anche per una settimana. È possibile sostituire le schede piene con schede vuote in qualsiasi momento.

Se interconnetti a cascata più duplicatori, ottieni registrazioni ancora più lunghe: una volta riempite tutte le schede della prima unità, la registrazione continua sul dispositivo connesso successivo, fino a quando l'ultima scheda dell'ultima unità è piena.

Modalità Single Disk Overwrite

Blackmagic Duplicator 4K registra su due o più schede SD in loop, uno slot alla volta. Quando una scheda è piena, formatta e passa a quella successiva garantendo una registrazione continua.

A differenza di Single Disk, non si ferma quando l'ultima scheda è piena ma continua a registrare sulla scheda successiva in loop, finché la registrazione non viene terminata manualmente.

SUGGERIMENTO Nelle modalità Single Disk e Single Disk Overwrite, puoi inserire schede SD in qualsiasi momento. Duplicator 4K continua a registrare finché rileva tra i 25 slot una scheda con spazio disponibile.

Come selezionare la modalità di registrazione:

- 1 Accendi Blackmagic Duplicator 4K.
- 2 Premi il pulsante MENU sul pannello di controllo per accedere al menù impostazioni dell'LCD. Premi il pulsante di registrazione illuminato a lato dello schermo.
In basso allo schermo appaiono puntini a indicare le opzioni di registrazione disponibili. Premi il pulsante di indietro per retrocedere nel menù, e usa i pulsanti < > per scorrere tra le opzioni.
- 3 Vai sulla modalità, e clicca su "Change".
- 4 Seleziona la modalità con "Select", e il menù del display LCD mostra l'opzione scelta.
- 5 Premi sul pulsante di indietro per tornare al menù di registrazione. Ora si visualizza l'opzione selezionata.

Per maggiori informazioni su come interconnettere più duplicatori, consulta le sezioni "Interconnessione" e "Interconnettere più unità Blackmagic Duplicator 4K".

SUGGERIMENTO Se stai registrando un evento importante in modalità Single Disk o Single Disk Overwrite, e vuoi estrarre la scheda sulla quale stai registrando prima che sia piena, tieni premuto il pulsante di registrazione per 3 secondi per far passare la registrazione alla scheda successiva. In modalità Duplicate, puoi premere il pulsante +. Consulta la sezione "Registrazione Append" per maggiori informazioni.

Impostare il codec

Blackmagic Duplicator 4K registra i file comprimendoli in H.264 o H.265. Di default, Duplicator 4K utilizza il codec H.264.

Per cambiare il codec:

- 1 Premi il pulsante MENU.
- 2 Premi il pulsante contestuale corrispondente alla voce "Record" per accedere alle impostazioni.
- 3 Naviga il menù "Codec" utilizzando i pulsanti contestuali, poi premi "Change".
- 4 Sfrutta i pulsanti contestuali per selezionare la codifica desiderata, poi premi SET per confermare oppure il pulsante MENU sul pannello di controllo per confermare e tornare alla schermata principale del display LCD.

NOTA Per cambiare il tipo di codifica, o codec, è necessario aggiornare Blackmagic Duplicator 4K alla versione 1.1. Tutti i dettagli su come aggiornare il software sono descritti nel capitolo "Blackmagic Duplicator Utility".

Scegliere il codec adatto

Per una maggiore compatibilità consigliamo di usare la codifica H.264, ovvero l'opzione di default di Blackmagic Duplicator 4K.

La codifica H.265 è ottima per i video Ultra HD di alta qualità dai file di dimensioni minori ma, essendo una tecnologia recente, potrebbe creare dei problemi di compatibilità con alcuni computer e dispositivi di riproduzione.

Entrambi i codec hanno i propri vantaggi. La codifica H.265 consente di lavorare con schede SD economiche perché i bitrate e le dimensioni dei file sono ridotti in base a una determinata qualità dell'immagine. La codifica H.264 è l'opzione più adatta se la compatibilità è un criterio indispensabile per il tuo progetto.

Impostare il bitrate

Le velocità di trasmissione selezionabili con Blackmagic Duplicator 4K sono tre: bassa (low), media (medium) e alta (high). La velocità di trasmissione definisce la quantità di dati scritti al secondo dal codificatore video H.265 interno. L'impostazione di partenza corrisponde alla velocità media, per registrare ad alta qualità su un file di dimensioni facilmente gestibili. Per cambiare l'impostazione di partenza, utilizza il menù del display LCD.

Per cambiare il bitrate:

- 1 Premi il pulsante MENU.
- 2 Premi il pulsante contestuale corrispondente alla voce REC per accedere alle impostazioni.
- 3 Naviga il menù "Bit Rate" utilizzando i pulsanti contestuali, poi premi "Change".
- 4 Sfrutta i pulsanti contestuali per selezionare la velocità di trasmissione desiderata, poi premi "Set" per confermare oppure il pulsante MENU sul pannello di controllo per confermare e tornare alla schermata principale del display LCD.

NOTA Un bitrate più elevato risulta in filmati di migliore qualità, ma sono necessarie schede più capienti e costose. Diminuendo il bitrate, aumenta lo spazio disponibile sulle schede ma si riduce la qualità delle immagini.

Perché non sperimentare la registrazione con bitrate differenti per trovare la soluzione a te più congeniale?

Registrazione contenuti

Per iniziare a registrare basta premere il pulsante di registrazione sul pannello di controllo frontale. Durante la registrazione le spie LED di status sopra gli slot si illuminano di rosso. Quando la registrazione si interrompe, le spie LED diventano verdi per segnalare che la scrittura è stata effettuata con successo e la scheda è pronta per ospitare nuovi contenuti. Per verificare i contenuti registrati è possibile utilizzare un computer inserendo la scheda SD nell'apposito slot o in un lettore esterno, oppure su un televisore HDMI che ammette il formato exFAT.

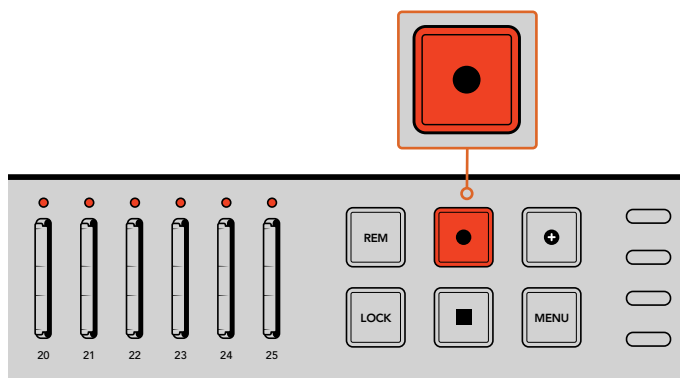





Premi il pulsante di registrazione per iniziare a registrare. La spia LED di stato situata sopra ogni slot si illumina di rosso per segnalare la registrazione in corso.

Spie LED di stato

Le spie LED di stato situate sopra ogni slot si illuminano di colori diversi a seconda delle operazioni in corso. Per esempio, la spia si illumina di verde quando la scheda SD inserita viene rilevata ed è pronta per la registrazione.

La lista seguente descrive lo stato corrispondente ad ogni colore:

-  **Verde fisso**
La scheda è pronta a registrare.
-  **Rosso fisso**
Registrazione in corso.
-  **Rosso lampeggiante**
Registrazione in corso con meno di 3 minuti di registrazione residua sulla scheda.
-  **Rosso lampeggiante rapido**
Saltano fotogrammi. La scheda SD non è sufficientemente veloce per la velocità di registrazione in corso.
-  **Giallo fisso**
Scheda piena, bloccata, o con errore di scrittura. La scheda SD è compromessa, bloccata, non ancora formattata, o con meno di 10 secondi di registrazione residua. Prova a spostare la levetta "Lock", a diminuire il data rate, a utilizzare una scheda SD più veloce, a formattarla, o a passare a un'altra scheda.

Il duplicatore protegge il sistema d'archiviazione nel caso in cui la scheda SD venga rimossa durante la registrazione. Tuttavia è sconsigliabile rimuovere la scheda durante la registrazione in corso, perché alcuni sistemi operativi non sono in grado di leggerla e tendono a mostrare contenuti danneggiati. Quindi prima di rimuovere la scheda SD, è importante interrompere la registrazione. Se desideri consegnare una scheda SD ad un cliente prima della fine dell'evento, la soluzione è quella di utilizzare un secondo duplicatore. Così facendo è possibile interrompere la registrazione sulla prima unità mentre la seconda continua a registrare.

SUGGERIMENTO Per registrazioni che non richiedono una qualità dell'immagine impeccabile, per esempio per le telecamere di sicurezza, sono sufficienti schede SD dalla numerazione più bassa. Consigliamo di testare la registrazione con il bitrate desiderato sulle schede SD per accertarsi che le immagini risultino soddisfacenti. Per maggiori informazioni sulla numerazione di velocità delle schede SD consulta la sezione "Inserire e formattare le schede SD" del capitolo "Operazioni preliminari".

Registrazione Append

In modalità Duplicate, puoi registrare una nuova clip e aggiungerla a quelle precedentemente archiviate, ottenendo un singolo filmato. Per esempio, se desideri salvare uno spettacolo composto da eventi diversi registrati individualmente in un solo file, sfrutta la funzione "Append".

- 1 Registra la prima clip premendo il pulsante di registrazione. Premi il pulsante di stop.
- 2 Per iniziare a registrare un nuovo evento, premi il pulsante "Append", contrassegnato con il segno +. Quando la registrazione "Append" è in corso, il pulsante di registrazione e quello + si illuminano. I contenuti registrati utilizzando questa funzione vengono aggiunti a quelli precedenti.
- 3 Premi il pulsante di stop. La nuova clip viene aggiunta alla clip precedente, e insieme salvate come un filmato singolo.

SUGGERIMENTO La funzione "Append" consente di unire più clip sulla stessa scheda a formare un file unico. Non c'è limite al numero di clip, ma vanno considerate la capienza della scheda e la lunghezza delle clip.

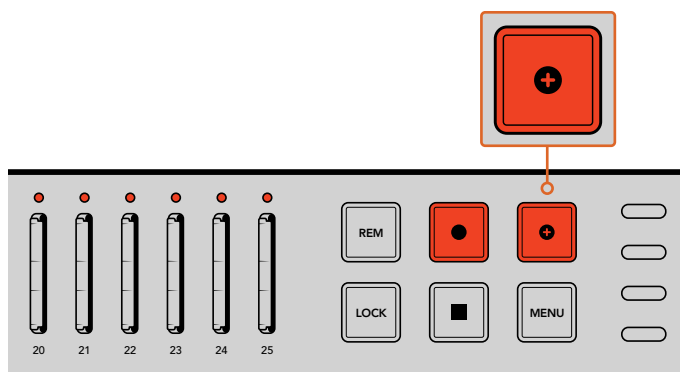

Premi il pulsante + per aggiungere la clip nuova a quella precedentemente registrata.

SUGGERIMENTO Nelle modalità Single Disk o Single Disk Overwrite puoi tener premuto il pulsante di registrazione per 3 secondi e far passare la registrazione sulla scheda successiva, rilasciando così la scheda corrente. Questo è utile se si vuole accedere alle clip di un evento importante immediatamente senza dover terminare la registrazione. Per maggiori informazioni sulle modalità Single Disk o Single Disk Overwrite, consulta la sezione “Impostare la modalità di registrazione”. In modalità Duplicate, puoi premere il pulsante +. Consulta la sezione “Registrazione Append” per maggiori informazioni.

Bloccare Blackmagic Duplicator 4K

Durante gli eventi in diretta, è importante bloccare i pulsanti del pannello di controllo per evitare di interrompere la registrazione per sbaglio. Per lo stesso motivo, è altresì necessario bloccare le altre unità interconnesse.

Per bloccare e sbloccare i pulsanti del pannello frontale, premi il pulsante LOCK su ogni unità. Sbloccare un'unità per sbaglio è improbabile perché per farlo il pulsante va premuto per due secondi.

Per bloccare Blackmagic Duplicator 4K:

- 1 Premi il pulsante LOCK sul pannello di controllo frontale.
- 2 Per sbloccare il dispositivo, tieni premuto il pulsante LOCK per due secondi.

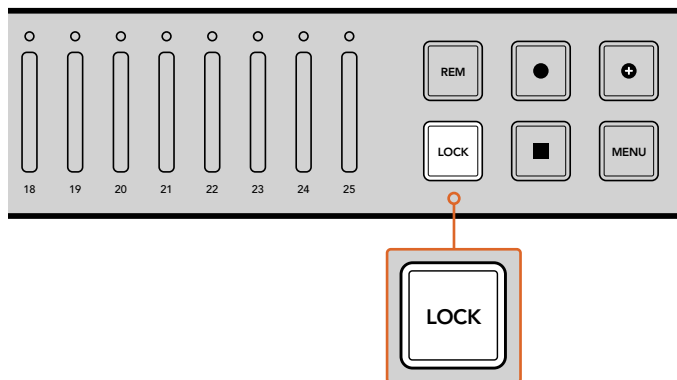

Blocca Blackmagic Duplicator 4K per evitare di interrompere la registrazione per sbaglio.

Interconnettere più unità Blackmagic Duplicator 4K

Per registrare su più di 25 schede SD, basta interconnettere più Blackmagic Duplicator 4K. Una volta collegati tra di loro, i duplicatori condividono lo stesso segnale attraverso la connessione SDI di loop di ogni dispositivo. Inoltre comunicano mediante i connettori REMOTE utilizzando il protocollo RS-422.

Per interconnettere più dispositivi Blackmagic Duplicator 4K:

- 1 Connetti la porta RS-422 REMOTE OUT della prima unità (unità di controllo) alla porta REMOTE IN della seconda unità (unità periferica), tramite un cavo seriale standard con connettori DB-9 (facilmente reperibile nei negozi di equipaggiamento video).
- 2 Connetti l'uscita SDI LOOP OUT dalla unità di controllo all'ingresso SDI IN dell'unità periferica.

Ora i duplicatori sono interconnessi! Per collegare altri Blackmagic Duplicator 4K segui lo stesso procedimento connettendo l'uscita REMOTE OUT e LOOP OUT agli ingressi REMOTE IN e SDI IN dell'unità periferica successiva, e così via.

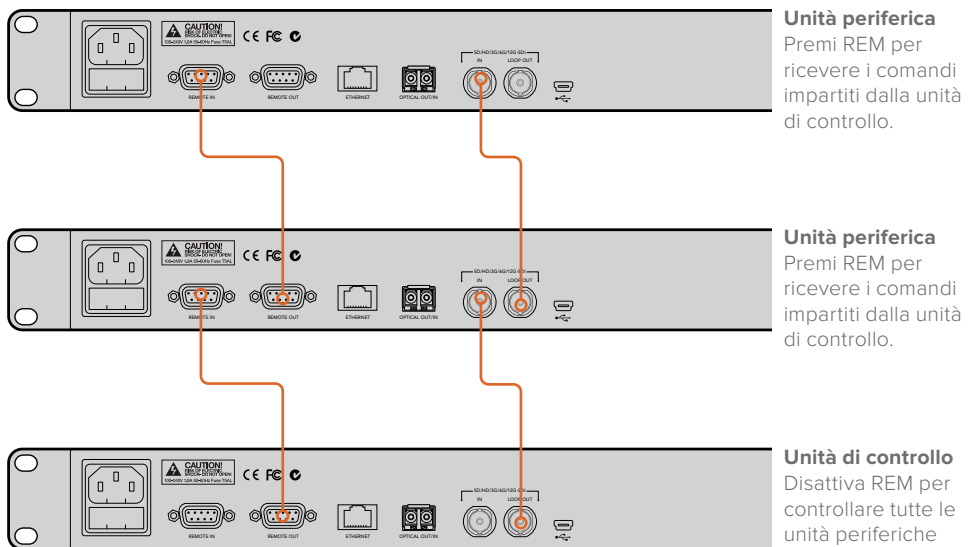

Per interconnettere più Blackmagic Duplicator 4K, connetti l'uscita di loop di una unità all'ingresso SDI della seconda unità. Poi connetti l'uscita REMOTE OUT della prima unità all'ingresso REMOTE IN della seconda.

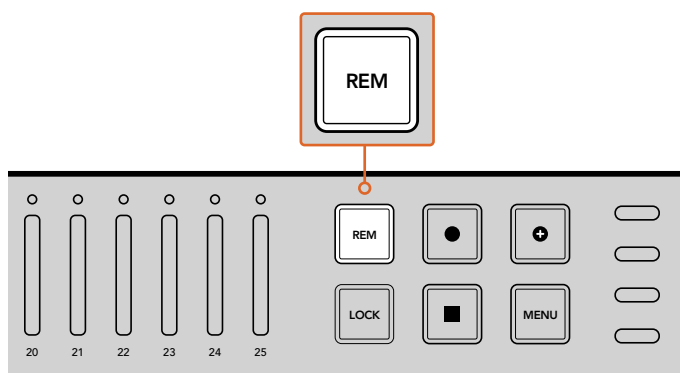

Premi il pulsante REM su ogni unità periferica per gestirla in modalità remota dalla unità di controllo.

NOTA Accertati che pulsante REM sia illuminato su tutte le unità periferiche per consentire la ricezione dei comandi dell'unità di controllo. Premi di nuovo REM per disattivare la funzione.

Consigliamo di testare la registrazione in modalità remota per appurarsi che tutte le unità periferiche siano controllate dalla unità di controllo. Se le unità periferiche non rispondono alla unità di controllo, accertati che il pulsante REM sia disabilitato sulla prima, e acceso su quelle periferiche.

Menù impostazioni del display LCD

Tutte le impostazioni di Blackmagic Duplicator 4K sono gestibili dal pannello di controllo tramite l'LCD e i pulsanti contestuali. I pulsanti si trovano a lato dell'LCD e si illuminano in corrispondenza dell'impostazione selezionata sul menù dell'LCD.

Come cambiare le impostazioni:

- 1 Premi il pulsante MENU sul pannello di controllo per aprire il menù impostazioni dell'LCD.
- 2 Utilizza i pulsanti contestuali per navigare il menù impostazioni.
- 3 Seleziona l'impostazione desiderata, e seleziona "Change".
- 4 Dopo aver regolato l'impostazione, premi "Set" per confermare.

Scegli "Back" per ritornare al menù precedente e annullare la selezione, oppure premi MENU sul pannello di controllo per tornare alla schermata iniziale dell'LCD.

Record

L'impostazione Record ti consente di cambiare la fonte video (video source), assegnare la velocità di trasmissione (bitrate), attivare o disattivare l'azionamento automatico della registrazione (trigger), e formattare le schede SD.

Video Source

Accedi a questa impostazione per selezionare l'ingresso SDI o il modulo SDI per fibra ottica, se presente.

Mode

Accedi a questa impostazione per selezionare la modalità di registrazione.

Duplicate

Registra lo stesso video su tutte le schede SD contemporaneamente.

Single Disk

Registra su una scheda SD alla volta, e una volta piena passa alla scheda SD successiva. Duplicator 4K termina la registrazione quando tutte le schede sono piene. Se hai interconnesso più unità, la registrazione continua sul Duplicator 4K successivo fino a che tutte le schede sono piene.

Single Disk Overwrite

Registra in loop continuo. Registra su una scheda SD alla volta, e una volta piena passa alla scheda SD successiva. Quando tutte le schede sono piene, Duplicator 4K continua la registrazione sulla prima scheda SD.

Codec

Accedi a questa impostazione per selezionare la codifica di compressione H.264 o H.265 su Blackmagic Duplicator 4K.

Le specifiche principali dei codec:

H.264

Comunemente più usata, questa codifica offre un valido compromesso tra qualità dell'immagine e dimensione del file. Gran parte dei dispositivi di riproduzione prodotti negli ultimi dieci anni ammette i file compressi con questo tipo di codifica, e quantomeno fino alla risoluzione HD.

H.265

Altamente efficiente, questa codifica è in grado di dimezzare le dimensioni dei file video dell'H.264 per una determinata qualità dell'immagine. Questa opzione è perfetta per comprimere video Ultra HD di alta qualità, ma potrebbe richiedere software e hardware di riproduzione più recenti.

NOTA Per approfondire la differenza tra H.264 e H.265, consulta il capitolo "Registrazione".

Bitrate

Accedi a questa impostazione per selezionare la qualità della registrazione e la dimensione del file. Scegli fra tre opzioni:

High

Seleziona High per la massima qualità delle immagini e la minima compressione.

Medium

Seleziona Medium per utilizzare più spazio nella scheda SD, e mantenere una buona qualità delle immagini.

Low

Seleziona Low per utilizzare più spazio possibile nella scheda SD, e ottenere una qualità delle immagini più bassa. In questo caso le immagini potrebbero risultare alterate.

NOTA Il codificatore integrato H.265 si avvale della tecnologia di compressione di ultima generazione, per ottenere registrazioni di ottima qualità anche con una compressione elevata.

Bitrate e formati video

Ultra HD			
Formato video	Bitrate	Bitrate (Mb/s) H.264	Bitrate (Mb/s) H.265
2160p60	Alto	75	50
	Medio	66	38
	Basso	50	20
2160p59.94	Alto	75	50
	Medio	66	38
	Basso	50	20

Ultra HD			
Formato video	Bitrate	Bitrate (Mb/s) H.264	Bitrate (Mb/s) H.265
2160p50	Alto	72	48
	Medio	61	32
	Basso	42	16
2160p30	Alto	50	30
	Medio	37	20
	Basso	24	10
2160p29.97	Alto	50	30
	Medio	37	20
	Basso	24	10
2160p25	Alto	40	25
	Medio	32	18
	Basso	20	10
2160p24	Alto	40	25
	Medio	32	18
	Basso	20	10
2160p23.98	Alto	40	25
	Medio	32	18
	Basso	20	10

HD			
Formato video	Bitrate	Bitrate (Mb/s) H.264	Bitrate (Mb/s) H.265
1080p60	Alto	40	20
	Medio	32	15
	Basso	20	10
1080i60	Alto	40	20
	Medio	32	15
	Basso	20	10
1080p59.94	Alto	40	20
	Medio	32	15
	Basso	20	10
1080i59.94	Alto	40	20
	Medio	32	15
	Basso	20	10
1080p50	Alto	36	20
	Medio	28	15
	Basso	18	10

HD			
Formato video	Bitrate	Bitrate (Mb/s) H.264	Bitrate (Mb/s) H.265
1080i50	Alto	36	20
	Medio	28	15
	Basso	18	10
1080p30	Alto	28	15
	Medio	20	11
	Basso	11	7
1080p29.97	Alto	28	15
	Medio	20	11
	Basso	11	7
1080p25	Alto	24	15
	Medio	16	10
	Basso	9	6
1080p24	Alto	24	15
	Medio	15	10
	Basso	8	6
1080p23.98	Alto	24	15
	Medio	15	10
	Basso	8	6
720p60	Alto	25	12
	Medio	17	10
	Basso	9	8
720p59.94	Alto	25	12
	Medio	17	10
	Basso	9	8
720p50	Alto	20	12
	Medio	14	9
	Basso	7	6

SD			
Formato video	Bitrate	Bit Rate (Mb/s) H.264	Bit Rate (Mb/s) H.265
625i50	Alto	18	11
	Medio	12	8
	Basso	6	6
525i59.94	Alto	20	12
	Medio	14	9
	Basso	7	6

Trigger

Questa impostazione consente di avviare e interrompere la registrazione su Blackmagic Duplicator 4K tramite il pulsante REC sui dispositivi SDI, per esempio sulla cinepresa Blackmagic URSA Mini.

None

Seleziona "None" per disattivare la funzione di registrazione automatica.

SDI Start/Stop

Seleziona "SDI Start/Stop" per attivare la registrazione su Blackmagic Duplicator 4K tramite il pulsante REC dei dispositivi SDI.

Per esempio, Blackmagic URSA Mini invia l'apposito segnale mediante le uscite SDI, cosicché premendo i pulsanti REC o STOP sulla cinepresa, Blackmagic Duplicator 4K avvia o interrompe la registrazione. La funzione "Trigger" è automatica sulla URSA Mini, ma quando si utilizzano altri dispositivi SDI che supportano questa funzione sarà necessario accedere al menù impostazioni e attivare l'opzione "SDI start/stop trigger rec".

Timecode Run

Se il tuo dispositivo non supporta la funzione di registrazione SDI start/stop, puoi impostare Blackmagic Duplicator 4K per avviare la registrazione non appena rileva il timecode attivo della fonte SDI. Per esempio, se la cinepresa SDI collegata a Blackmagic Duplicator 4K è impostata su "Rec Run Timecode", la registrazione si avvia sia sulla cinepresa che su Blackmagic Duplicator 4K. Quando la cinepresa interrompe la registrazione, si fermano anche il timecode e la registrazione su Blackmagic Duplicator 4K.

È una funzione utilissima, che si attiva selezionando l'impostazione "Timecode Rec Run" sul dispositivo SDI. Selezionando l'impostazione "Timecode Time of Day", Blackmagic Duplicator 4K rileva il timecode attivo e continua a registrare nonstop, quindi è importante assicurarsi che questa opzione non sia selezionata.

Formattare le schede SD

Formatta fino a 25 schede SD contemporaneamente con la funzione "Format" di Blackmagic Duplicator 4K.

Per formattare le schede SD:

- 1 Premi il pulsante MENU sul pannello di controllo per aprire il menù impostazioni dell'LCD.
- 2 Premi il pulsante contestuale corrispondente alla voce "Record" per accedere alle impostazioni.
- 3 Premi il pulsante contestuale a destra o a sinistra del display per selezionare "Format cards", e premi "Format".
- 4 Un messaggio chiederà di confermare il formato selezionato, e avviserà che questa operazione non può essere annullata. Se la scheda contiene già dati di registrazione, si consiglia di eseguire un back up.
- 5 Scegli "Format" per confermare, o "Cancel" per ritornare al menù impostazioni di "Record".
- 6 Le spie LED lampeggiano di giallo durante la formattazione delle schede SD, e una barra di avanzamento appare sull'LCD. Le spie si illuminano di verde a formattazione completata, e appare la conferma sull'LCD. Le schede SD sono pronte per la registrazione.
- 7 Premi OK. Premi il pulsante MENU per tornare alla schermata principale.

Impostazioni

Usa il menù “Settings” per cambiare le impostazioni di rete di Blackmagic Duplicator 4K, ad esempio DHCP ON/OFF, indirizzo IP, la maschera di sottorete (subnet mask) e il gateway. Collegando Blackmagic Duplicator 4K alla rete è possibile gestire il dispositivo tramite software di gestione remota come Telnet.

DHCP ‘ON’

Per consentire a Blackmagic Duplicator 4K di configurare le impostazioni di rete automatiche, seleziona ON. Blackmagic Duplicator 4K rileva e si conforma alle impostazioni di tutti i dispositivi collegati alla rete, incluso l’indirizzo IP, per evitare discrepanze di impostazioni. Questa funzione è ideale per configurare le impostazioni di rete velocemente e senza problemi.

DHCP ‘OFF’

Per il controllo manuale delle impostazioni di indirizzo IP, maschera di sottorete e gateway, imposta DHCP su OFF.

IP Address, Subnet Mask e Gateway

Per cambiare queste impostazioni manualmente, imposta DHCP su OFF.

Per cambiare i campi numerici:

- 1 Seleziona il campo numerico desiderato utilizzando i pulsanti contestuali a destra e a sinistra del display, poi premi “Change”.
- 2 Usa i pulsanti laterali per aumentare o diminuire i valori numerici (tieni premuto il pulsante per scorrere più velocemente).
- 3 Premi “Set” per confermare.

Usa i pulsanti laterali per spostarti all’interno della sequenza e fare i cambiamenti necessari.



Dal menù Settings dell’LCD puoi cambiare le impostazioni di rete e controllare Blackmagic Duplicator 4K tramite software di gestione remota come Telnet.

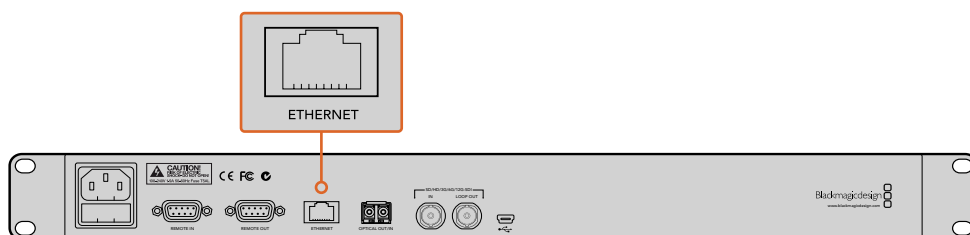

Connetti Blackmagic Duplicator 4K alla tua rete tramite la porta ethernet sul retro del pannello.

About

Questa impostazione offre una panoramica del bitrate, il nome del file della registrazione più recente, lo stato della rete e la versione del software interno di Blackmagic Duplicator 4K.

Blackmagic Duplicator Utility

Aggiornare Blackmagic Duplicator 4K

Blackmagic Duplicator Utility aggiorna il software interno di Blackmagic Duplicator 4K, e consente di cambiare il prefisso dei file per identificare con facilità i contenuti registrati. Si consiglia di scaricare gli aggiornamenti per utilizzare appieno le funzioni esistenti e migliorare le prestazioni di Blackmagic Duplicator 4K.

La versione più recente è disponibile per il download nella sezione Centro assistenza sulla pagina Supporto di Blackmagic Design www.blackmagicdesign.com/it/support

Per aggiornare il software interno con macOS:

- 1 Scarica e decomprimi il file zip di Blackmagic Duplicator Utility.
- 2 Apri l'immagine del disco e lancia l'installazione. Segui le istruzioni sullo schermo.
- 3 A installazione eseguita, connetti un cavo USB da Blackmagic Duplicator 4K al tuo computer.
- 4 Lancia l'utilità Blackmagic Duplicator Utility e accedi alle impostazioni cliccando sull'icona dell'ingranaggio. Se il software rileva una versione precedente di Blackmagic Duplicator 4K, apparirà l'icona "Update now". Clicca sull'icona per aggiornare il software interno. Se il software di Blackmagic Duplicator 4K è già aggiornato, non ci sono altre operazioni da eseguire.

Per aggiornare il software interno con Windows:

- 1 Scarica e decomprimi il file zip di Blackmagic Duplicator Utility.
- 2 Apparirà la cartella di Blackmagic Duplicator Utility, che contiene questo manuale e il programma di installazione Blackmagic Duplicator Utility. Fai clic doppio sull'icona dell'utility e segui le istruzioni per completare l'installazione.
- 3 A installazione eseguita, connetti un cavo USB da Blackmagic Duplicator 4K al tuo computer.
- 4 Lancia l'utilità Blackmagic Duplicator Utility e accedi alle impostazioni cliccando sull'icona dell'ingranaggio. Se il software rileva una versione precedente di Blackmagic Duplicator 4K, apparirà l'icona "Update now". Clicca sull'icona per aggiornare il software interno. Se il software di Blackmagic Duplicator 4K è già aggiornato, non ci sono altre operazioni da eseguire.

Prefisso del file

Cambia il prefisso dei file registrati per identificarli con facilità. Clicca nel campo "File Name Prefix" e digita il titolo desiderato. Quando Blackmagic Duplicator 4K registra la clip successiva, quest'ultima mostrerà il titolo inserito, seguito da quattro cifre uniche. Le cifre incrementano con ogni file registrato.

Premendo il pulsante REM su tutte le unità periferiche interconnesse e cambiando il prefisso del file sull'unità di controllo, la registrazione verrà salvata con lo stesso titolo su tutte le schede SD.

Installare il modulo opzionale Optical Fiber SDI Module

Per collegare i dispositivi video SDI tramite fibra ottica, è necessario installare il modulo opzionale Optical Fiber SDI Module. È possibile utilizzare qualsiasi modulo per fibra ottica SFP compatibile con lo standard SMPTE, e acquistarlo separatamente presso i rivenditori Blackmagic Design. Basta inserire il modulo nella gabbia per fibra ottica situata sul retro del pannello di Blackmagic Duplicator 4K. Il modulo per fibra ottica consente di trasportare i segnali video SDI con audio integrato tramite cavi a lunghissima distanza. Inoltre la connessione per fibra ottica funge anche da uscita di loop aggiuntiva.

Per elaborare i segnali in fibra ottica a bassa frequenza 3G-SDI o 6G-SDI, puoi installare un modulo dalle prestazioni più basse per risparmiare sui costi.

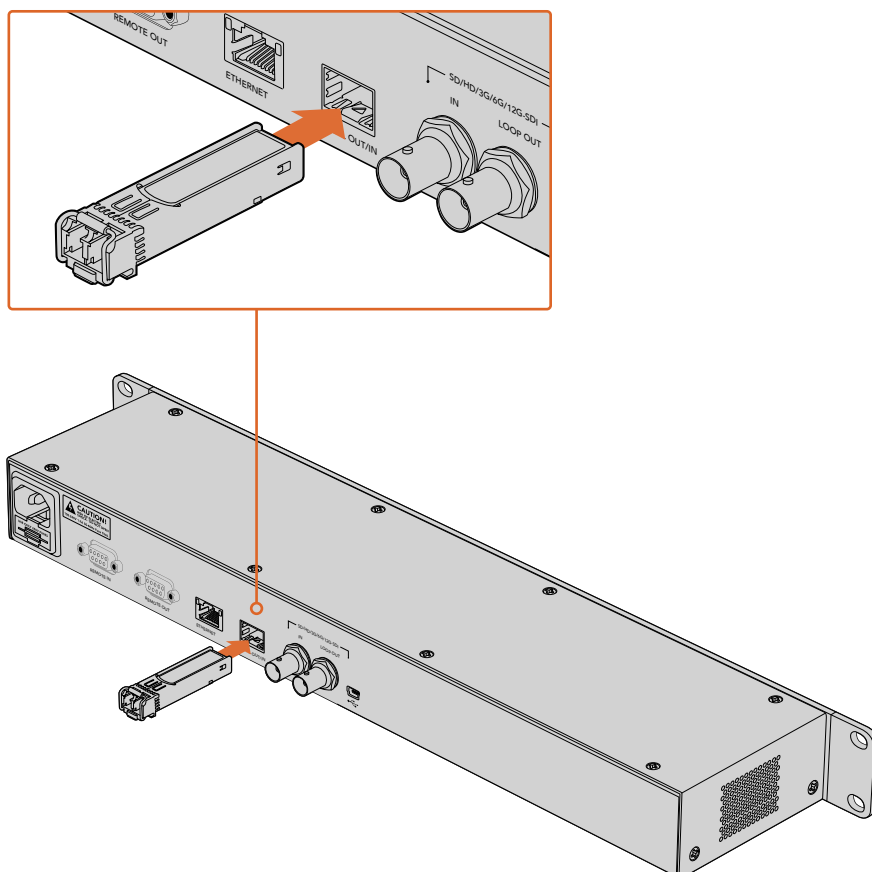

Connetti i dispositivi video SDI tramite fibra ottica installando il modulo opzionale Optical Fiber SDI Module.

Blackmagic Duplicator 4K legge il primo connettore SDI collegato. Se entrambi i connettori sono collegati, puoi selezionare la fonte desiderata nel menù impostazioni dell'LCD, alla voce "Video Source". Consulta la sezione "Impostazioni" per maggiori informazioni.

Protocollo RS-422

Cos'è il protocollo RS-422?

Il protocollo RS-422, lo standard broadcast per il controllo seriale utilizzato dalle emittenti sin dai primi anni ottanta, è già presente nei deck e nei prodotti di automazione, ed è compatibile con i programmi di montaggio lineari e non lineari. Blackmagic Duplicator 4K supporta questo standard, garantendo la perfetta integrazione ai sistemi broadcast di automazione, di controllo remoto e di registrazione, nonché di controllo personalizzato.

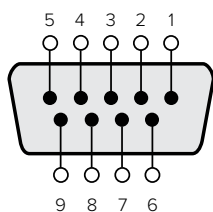

Transmit (-)	Transmit (+)	Receive (-)	Receive (+)	Ground Pins
2	7	8	3	1, 4, 6, 9

Pin del connettore RS-422 per la modalità remota.

Utilizzare un dispositivo di controllo esterno RS-422

Blackmagic Duplicator 4K ospita una porta RS-422 standard di controllo remoto, compatibile con Sony™ e con qualsiasi dispositivo di controllo remoto RS-422.

Puoi utilizzare cavi a 9 pin, assicurandoti che i connettori di entrambe le estremità abbiano la stessa configurazione. Se desideri realizzare cavi su misura per assecondare un cablaggio esistente, consulta il seguente diagramma di cablaggio per uscita di controllo remoto.

Connettendo un dispositivo esterno RS-422 al tuo Blackmagic Duplicator 4K, è possibile gestire quest'ultimo in modalità remota invece di utilizzare il pannello frontale.

- 1 Connetti il cavo RS-422 dal dispositivo di controllo esterno all'ingresso REMOTE IN di Blackmagic Duplicator 4K.
- 2 Premi il pulsante REM sul pannello di controllo frontale di Blackmagic Duplicator 4K per abilitare la funzione di controllo remoto.

Ora puoi avviare e interrompere la registrazione, e abilitare la funzione "Append" da un dispositivo di controllo esterno. La sezione successiva, intitolata "Comandi RS-422 compatibili", contiene l'elenco completo di tutti i comandi RS-422 compatibili.

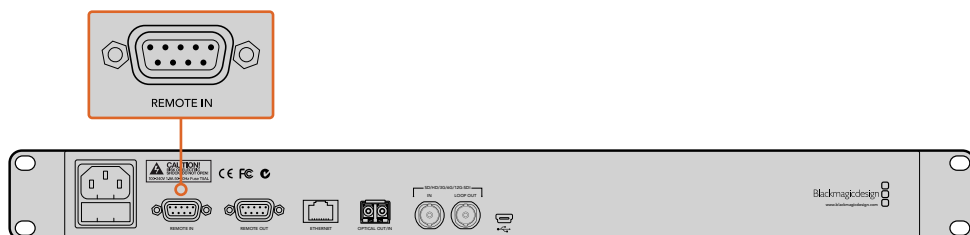

Connetti un dispositivo RS-422 di controllo esterno all'ingresso REMOTE IN di Blackmagic Duplicator 4K per gestire l'unità a distanza.

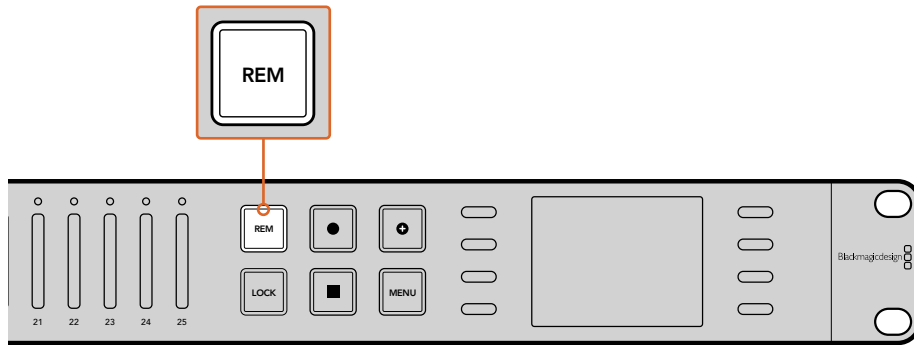

Premi il pulsante REM sul pannello di controllo frontale di Blackmagic Duplicator 4K per abilitare la funzione di controllo remoto RS-422.

Supported RS-422 Commands

		Command	Reply	No Remote	Notes
0 - System Control					
0x00	0x11	DeviceTypeRequest	NTSC: 0xF0E0 PAL: 0xF1E0 24P: 0xF2E0	Enabled	–
1 - Slave Response					
0x20	0x00	Stop	Acknowledge	Disabled	–
0x20	0x02	Record	Acknowledge	Disabled	–
0x21	0x02	Append	Acknowledge	Disabled	Non-standard command - an extra payload of 0x00 indicates append
4 - Preset/Select Control					
0x40	0x40	AutoMode Off	Acknowledge	Disabled	ignored, Status bit remembered
0x40	0x41	AutoMode On	Acknowledge	Disabled	ignored, Status bit remembered
0x61	0x20	StatusSense	StatusData	Enabled	–
7 - Sense Reply					
0x70	0x20	StatusData	–	–	Please see “Status Bits” sheet: Limited to 9 bytes of status, silently truncated

RS-422 Developer Information

	Bit 7	Bit 6	Bit 5	Bit 4	Bit 3	Bit 2	Bit 1	Bit 0
Byte 0	0	0	Cassette out	0	0	0	0	Local
Byte 1	Standby	0	Stop	0	0	0	Record	0
Byte 2	0	0	0	0	0	0	0	0
Byte 3	Auto Mode	0	0	0	0	0	0	0
Byte 4	Select EE	Full EE	0	0	0	0	0	0
Byte 5	0	0	0	0	0	0	0	0
Byte 6	0	0	0	0	0	0	0	0
Byte 7	0	0	0	0	0	0	0	0
Byte 8	0	0	0	0	0	0	0	0
Byte 9	0	0	0	0	0	0	0	0

Variables	
Cassette Out	Set if no cards are ready to record
Local	Set if in local mode (no remote control)
Standby	Set if one or more cards are ready to record
Auto Mode	For compatibility only
Full EE	For compatibility only - always on
Select EE	For compatibility only - always on

Blackmagic Duplicator 4K RS-422 Settings	
Protocol	Based on Sony 9-pin protocol
Baud Rate	38.4 K
Start Bits	1
Data Bits	8
Stop Bits	1
Parity Bits	1
Parity Type	Odd

Controllo remoto tramite ethernet

Blackmagic Duplicator 4K consente il controllo remoto tramite ethernet, sfruttando gli stessi comandi di testo del Blackmagic HyperDeck Ethernet Protocol. Con questa soluzione è possibile gestire Blackmagic Duplicator 4K da un computer utilizzando software di amministrazione come Telnet, oppure creare un pannello di controllo fisico personalizzato,

e programmarlo per una perfetta integrazione a Blackmagic Duplicator 4K utilizzando HyperDeck Ethernet Protocol.

Puoi sviluppare una soluzione di controllo personalizzata, e gestire il duplicatore da un computer, da dispositivi di controllo fisici o dai complessi sistemi degli studi broadcast e di regia mobile. Per esempio, i microcontroller Arduino sono piccole schede a circuito, personalizzabili con schede d'espansione. Sono disponibili vari tipi di schede, ognuna in grado di ospitare connettori diversi. Per gestire Blackmagic Duplicator 4K è necessaria una scheda ethernet. Sul mercato sono inoltre disponibili schede con pulsanti programmabili. Le schede Arduino sono facili da configurare, economiche e interamente open source. Dopo aver programmato il software Arduino, basta inserire la scheda nella porta ethernet di Blackmagic Duplicator 4K.

Un esempio di controllo tramite Arduino

Le schede Arduino sono programmate con il comune linguaggio C. Programma opportunamente la scheda per impartire i comandi al Blackmagic Duplicator 4K con i comandi compatibili di HyperDeck Ethernet Protocol, elencati nella sezione seguente, "Blackmagic HyperDeck Ethernet Protocol".

Per eseguire diverse funzioni di registrazione, è possibile aggiungere altre schede d'espansione alla scheda Arduino. Per esempio, inserendo un clock interno, puoi programmare la scheda di modo che Blackmagic Duplicator 4K registri ad orari specifici.

È una tecnologia innovativa e versatile, che apre le porte a numerose soluzioni su misura di controllo esterno tramite ethernet.



```
BlackmagicDuplicatorControl | Arduino 1.8.5
BlackmagiDuplicatorControl
/*
  Telnet client Blackmagic Duplicator 4K Control
  Circuit:
  * Ethernet shield attached to pins 10, 11, 12, 13
  */
#include <SPT.h>
#include <Ethernet.h>

// Enter a MAC address and IP address for your controller below.
// The IP address will be dependent on your local network:
byte mac[] = {0x90, 0xA7, 0xDA, 0x0F, 0x17, 0xEF};
byte ip[] = {192, 168, 28, 204}; //IP address of Ethernet Shield
byte server[] = {192, 168, 28, 85}; //IP address of Duplicator

EthernetClient client; //Give the ethernet client a name

void setup()
{
  Ethernet.begin(mac, ip); //Start the Ethernet connection:
  client.connect(server, 9993); //Connect to Duplicator on port 9993
}

void loop()
{
  while (client.available()) //Read the Duplicator Preamble
  {
    char c = client.read();
  }

  client.print("record: name: CAMERA\x0a"); //Start Duplicator recording a clip named Camera 1
  delay(60000); //Wait a minute
  client.print("stop\x0a"); //Stop recoding
  while (1); //Do nothing until program starts again
}
```

Done Saving

Sketch uses 9,710 bytes (30%) of program storage space. Maximum is 32,256 bytes.
Global variables use 236 bytes (11%) of dynamic memory, leaving 1,812 bytes for local variables. Maximum is 2,048 bytes.

36 Arduino/Genuino Uno on /dev/cu.usbmodem1421

Per programmare una scheda ethernet, come nell'esempio sopra indicato, consulta il protocollo ethernet qui sotto per trovare i comandi necessari.

Il codice mostrato nella finestra in alto è presente anche nella pagina successiva, che basta copiare e incollare nel software Arduino. Con questo codice, Arduino fa sì che Blackmagic Duplicator 4K registri per un minuto e interrompa la registrazione fino alla riattivazione del programma.

```

/*
   Telnet client Blackmagic Duplicator 4K Control Circuit: *
Ethernet shield attached to pins 10, 11, 12, 13
*/
#include <SPI.h>
#include <Ethernet.h>

// Enter a MAC address and IP address for your controller below.
// The IP address will be dependent on your local network:
byte mac[] = {0x90, 0xA2, 0xDA, 0x0F, 0x17, 0xEF};
byte ip[] = {192, 168, 28, 204};           // IP address of
Ethernet Shield
byte server[] = {192, 168, 28, 141};      // IP address of Duplicator
EthernetClient client;                   // Give the ethernet
client a name

void setup()
{
  Ethernet.begin(mac, ip);               //Start the Ethernet connection:

  client.connect(server, 9993);          //Connect to Duplicator on port 9993
}
void loop()
{
  while (client.available()) //Read the Duplicator Preamble
  {
    char c = client.read();
  }
  client.print("record: name: Cameral\x0a");
  //Start Duplicator recording a clip named Camera 1
  delay(60000);                          //Wait a minute
  client.print("stop\x0a");               //Stop recoding
  while (1);                              //Do nothing until program
starts again
}

```

Blackmagic HyperDeck Ethernet Protocol

Basato su comandi di testo, Blackmagic HyperDeck Ethernet Protocol era stato originariamente scritto per gestire i registratori su disco Blackmagic HyperDeck tramite una porta ethernet. Lo stesso protocollo gestisce anche Blackmagic Duplicator 4K.

Poiché il duplicatore è solo in grado di registrare, non dispone dell'intero set di comandi di HyperDeck. Questa sezione mostra i comandi disponibili e pertinenti all'utilizzo dell'HyperDeck Ethernet Protocol con il duplicatore.

Protocol Commands

Command	Command Description
help or ?	Provides help text with all commands and parameters.
remote	Queries the state of HyperDeck's remote control mode.
remote: enable: true	Enables remote control.
remote: enable: false	Disables remote control.
remote: override: true	Turns remote override on.
remote: override: false	Turns remote override off.
quit	Disconnects HyperDeck server.
ping	Determines HyperDeck server is responding.
record	Starts recording.
record: append: true	Starts appended recording.
stop	Stops playback or recording.
commands	Lists all supported commands in an XML format.
notify	Queries the current state of all notifications.
notify: transport: true	Enables transport notifications.
notify: transport: false	Disables transport notifications.
notify: slot: true	Enables slot notifications.
notify: slot: false	Disables slot notifications.
notify: remote: true	Enables remote notifications.
notify: remote: false	Disables remote notifications.
notify: configuration: true	Enables configuration notifications.
notify: configuration: false	Disables configuration notifications.
notify: dropped frames: true	Enables dropped frames notifications.
notify: dropped frames: false	Disables dropped frames notifications.
device info	Provides device information.
slot info: slot id: {slot ID}	Provides information about a specified slot.
transport info	Provides information for the state of the transport.
configuration	Queries the current configuration.
configuration: record mode: Duplicate	Configures the record mode to duplicate.

Command	Command Description
configuration: record mode: SingleDisk	Configures the record mode to single disk.
configuration: record mode: DiskOverwrite	Configures the record mode to disk overwrite.
configuration: video input: {"SDI", "optical"}	Configures video input.
configuration: file format: {format}	Configures the record codec and bit rate.
format: prepare: {format}	prepare a disk formatting operation to filesystem {format}
format: confirm: {token}	perform a pre-prepared formatting operation using token
watchdog: period: {seconds}	Configures the watchdog.

Utilizzare XML

Oltre a utilizzare il terminale per comunicare con HyperDeck, durante la programmazione del software puoi utilizzare l'XML per confermare l'esistenza di un comando specifico basato sul firmware dell'HyperDeck con il quale è collegato. In questo modo l'interfaccia può regolarsi secondo lo specifico modello HyperDeck e la versione del software.

Protocol Details

Connection

The HyperDeck Ethernet server listens on TCP port 9993.

Basic syntax

The HyperDeck protocol is a line oriented text protocol. Lines from the server will be separated by an ASCII CR LF sequence. Messages from the client may be separated by LF or CR LF.

New lines are represented in this document as a "↵" symbol.

Command syntax

Command parameters are usually optional. A command with no parameters is terminated with a new line:

```
{Command name}↵
```

If parameters are specified, the command name is followed by a colon, then pairs of parameter names and values. Each parameter name is terminated with a colon character:

```
{Command name}: {Parameter}: {Value} {Parameter}: {Value} ...↵
```

Response syntax

Simple responses from the server consist of a three digit response code and descriptive text terminated by a new line:

```
{Response code} {Response text}↵
```

If a response carries parameters, the response text is terminated with a colon, and parameter name and value pairs follow on subsequent lines until a blank line is returned:

```
{Response code} {Response text}:↵
{Parameter}: {Value}↵
{Parameter}: {Value}↵
...
↵
```

Successful response codes

A simple acknowledgement of a command is indicated with a response code of 200:

```
200 ok↵
```

Other successful responses carry parameters and are indicated with response codes in the range of 201 to 299.

Failure response codes

Failure responses to commands are indicated with response codes in the range of 100 to 199:

```
100 syntax error
101 unsupported parameter
102 invalid value
103 unsupported
104 disk full
105 no disk
106 disk error
109 out of range
110 no input
111 remote control disabled
120 connection rejected
150 invalid state
```

Asynchronous response codes

The server may return asynchronous messages at any time. These responses are indicated with response codes in the range of 500 to 599:

```
5xx {Response Text}:↵
{Parameter}: {Value}↵
{Parameter}: {Value}↵
↵
```

Connection response

On connection, an asynchronous message will be delivered:

```
500 connection info:↵
protocol version: {Version}↵
model: {Model Name}↵
↵
```

Connection rejection

Only one client may connect to the server at a time. If other clients attempt to connect concurrently, they will receive an error and be disconnected:

```
120 connection rejected↵
```

Timecode syntax

Timecodes are expressed as non-drop-frame timecode in the format:

```
HH:MM:SS:FF
```

Handling of deck "remote" state

The "remote" command may be used to enable or disable the remote control of the deck. Any attempt to change the deck state over ethernet while remote access is disabled will generate an error:

```
111 remote control disabled↵
```

To enable or disable remote control:

```
remote: enable: {"true", "false"} ↵
```

The current remote control state may be overridden allowing remote access over ethernet irrespective of the current remote control state:

```
remote: override: {"true", "false"} ↵
```

The override state is only valid for the currently connected ethernet client and only while the connection remains open.

The "remote" command may be used to query the remote control state of the deck by specifying no parameters:

```
remote↵
```

The deck will return the current remote control state:

```
210 remote info:↵
enabled: {"true", "false"}↵
override: {"true", "false"}↵
↵
```

Asynchronous remote control information change notification is disabled by default and may be configured with the "notify" command. When enabled, changes in remote state will generate a "510 remote info:" asynchronous message with the same parameters as the "210 remote info:" message.

Closing connection

The "quit" command instructs the server to cleanly shut down the connection:

```
quit↵
```

Checking connection status

The "ping" command has no function other than to determine if the server is responding:

```
ping↵
```

Getting help

The "help" or "?" commands return human readable help text describing all available commands and parameters:

```
help↵
```

or:

```
?↵
```

The server will respond with a list of all supported commands:

```
201 help:↵
{Help Text}↵
{Help Text}↵
↵
```

Stopping deck operation

The "stop" command instructs the deck to stop the current capture:

```
stop↵
```

Enumerating supported commands and parameters

The "commands" command returns the supported commands:

```
commands↵
```

The command list is returned in a computer readable XML format:

```
212 commands:
<commands>↵
    <command name="..."><parameter name="..."/>...</command>↵
    <command name="..."><parameter name="..."/>...</command>↵
    ...
</commands>↵
↵
```

More XML tokens and parameters may be added in later releases.

Controlling asynchronous notifications

The "notify" command may be used to enable or disable asynchronous notifications from the server. To enable or disable transport notifications:

```
notify: transport: {"true", "false"}↵
```

To enable or disable slot notifications:

```
notify: slot: {"true", "false"}↵
```

To enable or disable remote notifications:

```
notify: remote: {"true", "false"}↵
```

To enable or disable configuration notifications:

```
notify: configuration: {"true", "false"}↵
```

To enable or disable dropped frames notifications:

```
notify: dropped frames: {"true", "false"}↵
```

Multiple parameters may be specified. If no parameters are specified, the server returns the current state of all notifications:

```
209 notify:↵
transport: {"true", "false"}↵
slot: {"true", "false"}↵
remote: {"true", "false"}↵
configuration: {"true", "false"}↵
↵
```

Retrieving device information

The "device info" command returns information about the connected deck device:

```
device info↵
```

The server will respond with:

```
204 device info:↵
protocol version: {Version}↵
model: {Model Name}↵
unique id: {unique alphanumeric identifier}↵
↵
```

Example of response from server:

```
204 device info:↵
protocol version: 1.8↵
model: Blackmagic Duplicator 4K↵
unique id: 101112131415↵
↵
```

Retrieving slot information

The "slot info" command returns information about a slot.

The specified slot will be queried:

```
slot info: slot id: {Slot ID}↵
```

The server will respond with slot specific information:

```
202 slot info:↵
slot id: {Slot ID}↵
status: {"empty", "mounting", "error", "mounted"}↵
volume name: {Volume name}↵
recording time: {recording time available in seconds}↵
video format: {disk's default video format}↵
↵
```

Asynchronous slot information change notification is disabled by default and may be configured with the “notify” command. When enabled, changes in slot state will generate a “502 slot info:” asynchronous message with the same parameters as the “202 slot info:” message.

Retrieving transport information

The “transport info” command returns the state of the transport:

```
transport info ↵
```

The server responds with transport specific information:

```
208 transport info:↵  
status: {"stopped","record"}↵  
display timecode: {timecode}↵  
timecode: {timecode}↵
```

The “timecode” value is the timecode within the current timeline for playback or the clip for record. The “display timecode” is the timecode displayed on the front of the deck. The two timecodes will differ in some deck modes.

Asynchronous transport information change notification is disabled by default and may be configured with the “notify” command. When enabled, changes in transport state will generate a “508 transport info:” asynchronous message with the same parameters as the “208 transport info:” message.

Video Formats

The following video formats are currently supported on Blackmagic Duplicator 4K:

SD

525i59.94 NTSC
625i50 PAL

HD

720p50	1080p30
720p59.94	1080i50
720p60	1080p50
1080p23.98	1080i59.94
1080p24	1080p59.94
1080p25	1080i60
1080p29.97	1080p60

Ultra HD

2160p23.98	2160p30
2160p24	2160p50
2160p25	2160p59.94
2160p29.97	2160p60

Duplicator 4K supports progressive segmented frame modes, and automatically detects level A and level B 3G-SDI formats for 1080p50, 1080p59.94 and 1080p60.

File Formats

Duplicator 4K supports the following file formats:

- H.264Low
- H.264Medium
- H.264High
- H.265Low
- H.265Medium
- H.265High

Querying and updating configuration information

The "configuration" command may be used to query the current configuration of the deck:

```
configuration↵
```

The server returns the configuration of the deck:

```
211 configuration:↵  
video input: {"SDI", "optical"}↵  
↵
```

One or more configuration parameters may be specified to change the configuration of the deck.

To change the current video input:

```
configuration: video input: {"SDI", "optical"}↵
```

Configuring the watchdog

The "watchdog" command instructs the deck to monitor the connected client and terminate the connection if the client is inactive for at least a specified period of time.

To configure the watchdog:

```
watchdog: period: {period in seconds}↵
```

To avoid disconnection, the client must send a command to the server at least every {period} seconds. Note that if the period is set to 0 or less than 0, connection monitoring will be disabled.

Configuring the record mode

Use the 'record mode' command to select the deck recording mode:

```
configuration: record mode: {"Duplicate", "SingleDisk", "DiskOverwrite"}↵
```

Configuring the file format

The 'file format' command instructs the deck to switch to a specific file format for codec and bit rate:

```
configuration: file format: {"H.264High", "H.264Medium", "H.264Low",  
"H.265High", "H.265Medium", "H.265Low"}↵
```

Assistenza

Supporto tecnico

Il modo più veloce di ottenere assistenza è visitare la pagina di supporto clienti di Blackmagic Design. Lì troverai sempre il materiale di supporto più recente per il tuo Blackmagic Duplicator 4K.

Pagina di supporto online di Blackmagic Design

Per il materiale più recente, inclusi software e note di supporto, visita il Centro assistenza di Blackmagic Design su www.blackmagicdesign.com/it/support

Il Forum Blackmagic Design

La pagina Forum del nostro sito web Blackmagic Design è un'ottima risorsa per ottenere informazioni utili e condividere idee creative. Qui troverai le risposte alle domande più frequenti, oltre ai consigli degli utenti esistenti e dello staff Blackmagic Design. Visita il nostro Forum su <https://forum.blackmagicdesign.com>

Contatta Blackmagic Design

Se il materiale sulla nostra pagina Forum non risponde alle tue domande, clicca su "Invia una email" nella pagina Supporto, oppure clicca su "Trova un team di supporto" per contattare direttamente il team di Blackmagic Design più vicino a te.

Come verificare la versione del software

Per verificare quale versione del software Blackmagic Duplicator Utility è installata sul tuo computer, apri la tab About del software.

- Su macOS, apri la cartella Applicazioni e seleziona Blackmagic Duplicator Utility. Clicca su About Blackmagic Duplicator Utility dal menù dell'applicazione per scoprirne la versione.
- Su Windows 8.1, apri Blackmagic Duplicator Utility dall'icona Blackmagic Duplicator Utility nella pagina Start. Clicca su Help e seleziona About Blackmagic Duplicator Utility per scoprirne la versione.
- Su Windows 10, seleziona Blackmagic Duplicator Utility dal menù Start. Clicca su Help e seleziona About Blackmagic Duplicator Utility per scoprirne la versione.

Dove trovare gli aggiornamenti più recenti del software

Dopo aver verificato quale versione del software Blackmagic Duplicator Utility è installata sul tuo computer, visita il Centro assistenza di Blackmagic Design su www.blackmagicdesign.com/it/support per scaricare gli aggiornamenti più recenti. Ti consigliamo di non aggiornare il software se stai lavorando ad un progetto importante.

Normative

Smaltimento di apparecchiature elettriche ed elettroniche nell'Unione Europea



Questo simbolo indica che il prodotto non deve essere smaltito insieme agli altri rifiuti, ma consegnato a uno degli appositi centri di raccolta e riciclaggio. La raccolta e lo smaltimento differenziato corretto di questo tipo di apparecchiatura evita lo spreco di risorse e contribuisce alla sostenibilità ambientale e umana. Per tutte le informazioni sui centri di raccolta e riciclaggio, contatta gli uffici del tuo comune di residenza o il punto vendita presso cui hai acquistato il prodotto.



Questo dispositivo è stato testato e dichiarato conforme ai limiti relativi ai dispositivi digitali di Classe A, ai sensi dell'articolo 15 del regolamento FCC. Tali limiti sono stati stabiliti con lo scopo di fornire protezione ragionevole da interferenze dannose in ambienti commerciali. Questo apparecchio genera, usa e può irradiare energia a radiofrequenza e, se non è installato o usato in conformità alle istruzioni, può causare interferenze dannose che compromettono le comunicazioni radio. Operare questo prodotto in ambienti residenziali può causare interferenze dannose, nella cui evenienza l'utente dovrà porvi rimedio a proprie spese.

Il funzionamento è soggetto alle due condizioni seguenti:

- 1 Il dispositivo non deve causare interferenze dannose.
- 2 Il dispositivo deve accettare eventuali interferenze ricevute, incluse le interferenze che possono causare un funzionamento indesiderato.

Dichiarazione ISED (Canada)

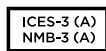

Questo dispositivo rispetta gli standard canadesi per gli apparecchi digitali di Classe A.

Qualsiasi modifica o utilizzo del dispositivo al di fuori di quello previsto potrebbe invalidare la conformità a tali standard.

Questo dispositivo è stato testato per l'uso in ambienti commerciali. Se utilizzato in ambienti domestici, può causare interferenze radio.

Sicurezza

Collegare il dispositivo a una presa di corrente con messa a terra per evitare scosse elettriche.

Per assistenza, contattare un elettricista qualificato.

Per ridurre il rischio di scosse elettriche, evitare di esporre il dispositivo a gocce o spruzzi.

Questo prodotto è adatto all'uso nei luoghi tropicali con una temperatura ambiente non superiore ai 40°C.

Lasciare uno spazio adeguato intorno al prodotto per consentire sufficiente ventilazione.

Se il dispositivo è installato su rack, assicurarsi che i dispositivi adiacenti non ne ostacolino la ventilazione.

Le parti all'interno del prodotto non sono riparabili dall'utente. Contattare il personale qualificato di un centro Blackmagic Design per le operazioni di manutenzione.

Alcuni prodotti ospitano una porta per connettere ricetrasmittitori ottici SFP. Usare solo moduli SFP Laser, Class 1.

Moduli SFP consigliati da Blackmagic Design:

- **3G-SDI:** PL-4F20-311C
- **6G-SDI:** PL-8F10-311C
- **12G-SDI:** PL-TG10-311C



Usare il dispositivo a un'altitudine non superiore a 2000 m sopra il livello del mare.

Dichiarazione dello Stato della California

Questo prodotto può esporre l'utente a sostanze chimiche come il cromo esavalente, riconosciuto nello Stato della California come causa di cancro e difetti alla nascita o altri difetti riproduttivi.

Per maggiori informazioni, visita la pagina www.P65Warnings.ca.gov

Avvertenze per il personale autorizzato



Attenzione — Fusione bipolare/neutra

L'alimentatore all'interno di questo dispositivo ha un fusibile nei conduttori di linea e di neutro, ed è idoneo alla connessione al sistema di distribuzione di energia IT in Norvegia.

Garanzia

Garanzia limitata di un anno

Blackmagic Design garantisce che il prodotto Blackmagic Duplicator 4K è fornito privo di difetti nei materiali e nella manifattura per un periodo limitato di un anno a partire dalla data d'acquisto. Durante il periodo di garanzia Blackmagic Design riparerà o, a sua scelta, sostituirà tutti i componenti che risultino difettosi esonerando il cliente da costo aggiuntivi, purché questi vengano restituiti dal Cliente.

Per ottenere l'assistenza coperta dalla presente garanzia, il Cliente deve notificare Blackmagic Design del difetto entro il periodo di garanzia. Il Cliente è responsabile del costo di imballaggio e di spedizione del prodotto al centro di assistenza indicato da Blackmagic Design. Il costo include spedizione, assicurazione, tasse, dogana, e altre spese pertinenti alla resa del prodotto a Blackmagic Design.

Questa garanzia perde di validità per danni causati da un utilizzo improprio, o da manutenzione e cura inadeguate del prodotto. Blackmagic Design non ha obbligo di assistenza e riparazione sotto garanzia per danni al prodotto risultanti da: a) previ tentativi di installazione, riparazione o manutenzione da personale non autorizzato, ovvero al di fuori del personale Blackmagic Design, b) previ usi impropri o tentativi di connessione ad attrezzatura incompatibile al prodotto, c) previo uso di parti o ricambi non originali Blackmagic Design, o d) previe modifiche o integrazione del prodotto ad altri prodotti, con il risultato di rendere la riparazione più difficoltosa o di allungare le tempistiche di eventuali ispezioni atte alla riparazione. La presente garanzia di Blackmagic Design sostituisce qualsiasi altra garanzia, esplicita o implicita. Blackmagic Design e i suoi fornitori escludono qualsiasi altra garanzia implicita di commerciabilità o di idoneità ad un uso specifico. L'intera responsabilità di Blackmagic Design e l'unico esclusivo ricorso dell'utente per qualsiasi danno arrecato di natura indiretta, specifica, accidentale o consequenziale, anche qualora Blackmagic Design fosse stata avvertita della possibilità di tali danni, è la riparazione o la sostituzione dei prodotti difettosi. Blackmagic Design non si assume alcuna responsabilità per qualsiasi uso illegale del dispositivo da parte del Cliente. Blackmagic Design non si assume alcuna responsabilità per danni derivanti dall'uso di questo prodotto. Il Cliente utilizza questo prodotto a proprio rischio.

© Copyright 2019 Blackmagic Design. Tutti i diritti riservati. 'Blackmagic Design', 'DeckLink', 'HDLink', 'Workgroup Videohub', 'Videohub', 'DeckLink', 'Intensity' and 'Leading the creative video revolution' sono marchi registrati negli Stati Uniti e in altri Paesi. Altri nomi di prodotti e aziende qui contenuti possono essere marchi dei rispettivi proprietari. Thunderbolt e il logo Thunderbolt sono marchi registrati di Intel Corporation negli Stati Uniti e/o altri Paesi.

Blackmagicdesign



Manual de Instalação e Operação

Blackmagic Duplicator 4K

Fevereiro 2019

Português



Prezado Cliente,

Obrigado por adquirir o Blackmagic Duplicator 4K.

Estamos muito entusiasmados com este produto e o consideramos a solução perfeita para tornar possível distribuir conteúdo Ultra HD de alta qualidade diretamente aos seus clientes. Isso é possível porque o duplicador grava separadamente em até 25 cartões SD em todos os formatos SD, HD e Ultra HD de até 2160p60 com compressão H.264, amplamente usada, ou com a compressão H.265 de última geração. Assim, você conta com uma excelente qualidade e taxas de quadro altas, mas com taxas de dados baixas o suficiente para gravações de longa duração usando cartões acessíveis.

O Blackmagic Duplicator 4K é fácil de usar e configurar. O painel frontal inclui um painel de controle e tela LCD integrados para que você possa alterar as configurações e controlar a unidade usando botões. Mas, também é possível controlar o seu duplicador remotamente via Ethernet ou conectando um controlador RS-422. Inclusive, você pode criar seu próprio controlador personalizado e controlar a unidade usando o Blackmagic HyperDeck Ethernet Protocol.

O codificador H.265 em tempo real integrado grava vídeos de alta qualidade em cartões SD acessíveis em formatos de vídeo Ultra HD de até 2160p60, assim você pode gravar vídeos Ultra HD incríveis sem precisar usar os cartões mais rápidos disponíveis. Na versão 1.2 do software Blackmagic Duplicator 4K, adicionamos compressão H.264 para que você também possa gravar arquivos H.264 e tenha maior compatibilidade.

O Blackmagic Duplicator 4K ocupa uma unidade de rack, ou seja, você pode montar várias unidades em cascata em um sistema de rack portátil e levá-las em locações de filmagem podendo sempre gravar em centenas de cartões SD ao mesmo tempo.

Esse manual de instrução contém todas as informações que você precisa para começar a usar o Blackmagic Duplicator 4K.

Consulte a página de suporte no nosso site em www.blackmagicdesign.com/br para a versão mais recente deste manual e para atualizações do software do seu Blackmagic Duplicator 4K. Para garantir que você receba todos os recursos mais recentes, mantenha o seu programa atualizado! Ao baixar o software, registre suas informações para que possamos informar quando novas versões do software forem lançadas. Estamos constantemente trabalhando em novos recursos e melhorias, por isso gostaríamos de receber suas opiniões e comentários!

Grant Petty

Diretor Executivo da Blackmagic Design

Índice

Blackmagic Duplicator 4K

Instruções preliminares	339
Conexão de alimentação	339
Conexão de vídeo e áudio	339
Interligação em cascata	340
Inserção e formatação de cartões SD	341
Gravação	342
Configuração de modos de gravação	342
Configuração de codecs	343
Configuração de taxas de bit	344
Gravar clipes	345
Indicadores LED de status	345
Anexar gravação	346
Bloquear o Blackmagic Duplicator 4K	347
Interligação de múltiplos duplicadores em cascata	347
Configurações do menu LCD	349
Record	349
Settings	354
About	355
Utilitário Blackmagic Duplicator	355
Atualização do Blackmagic Duplicator 4K	355
Prefixo do nome de arquivo	355
Instalação do módulo de fibra óptica SDI opcional	356
Controle RS-422	357
O que é controle RS-422?	357
Como usar um controlador RS-422 externo	357
Informações para desenvolvedores RS-422	359
Controle Remoto via Ethernet	359
Exemplo de controle via um Arduino	360
Blackmagic HyperDeck Ethernet Protocol	362
Protocolo de Comandos (em inglês)	362
Detalhes do Protocolo (em inglês)	363
Configuring the watchdog	368
Configuring the record mode	368
Configuring the file format	368
Ajuda	369
Informações regulatórias	370
Informações de segurança	371
Garantia	372

Instruções preliminares

Começar a usar o seu Blackmagic Duplicator 4K é fácil!

Basta conectá-lo à energia, à sua fonte de vídeo SDI e inserir até 25 cartões SD. Caso queira gravar em número ainda maior de cartões SD, você pode montar múltiplas unidades Blackmagic Duplicator 4K em cascata e isto é muito simples de fazer, pois há conexões de controle e vídeo integradas para conexão com cada unidade downstream. Esta seção do manual mostrará exatamente como configurar seu Blackmagic Duplicator 4K para que você possa começar a gravar imediatamente em múltiplos cartões SD ao mesmo tempo.

Conexão de alimentação

Para alimentar seu Blackmagic Duplicator 4K, basta conectar um cabo de alimentação IEC padrão à entrada de alimentação AC de 110 - 240 V no painel traseiro.

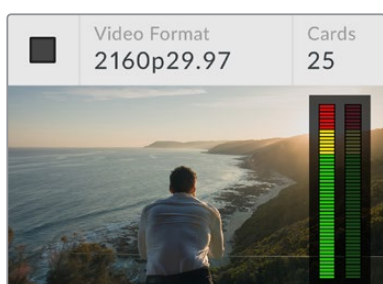

Ao ligar o Blackmagic Duplicator 4K, a tela inicial aparecerá no LCD integrado.

Tela inicial

A tela inicial exibe a imagem do vídeo de origem e informações, como o formato do vídeo de origem, a quantidade de cartões SD inseridos, um indicador de status que indica quando você está gravando e quando a gravação é parada, além de medidores de áudio para que você possa monitorar os níveis de áudio no seu vídeo de origem.

Conexão de vídeo e áudio

Conecte seu vídeo de origem à entrada 12G-SDI no painel traseiro. O Blackmagic Duplicator 4K detectará o formato de entrada automaticamente e o exibirá na tela inicial no LCD.

Os conectores BNC de entrada e saída SDI são compatíveis com sinais de vídeo de até 12G-SDI, portanto você pode conectar vídeos SD, HD ou Ultra HD de até 2160p60 com um único cabo BNC. Isso significa que a saída loop sempre se corresponderá ao formato do vídeo de origem para que você possa emitir o mesmo sinal a outros equipamentos de vídeo SDI, ou para montar muitos Blackmagic Duplicator 4K juntos em cascata. Ela também inclui compatibilidade com modos de quadro segmentados progressivos e detecta formatos 3G-SDI nível A e B para 1080p50, 1080p59.94 e 1080p60.

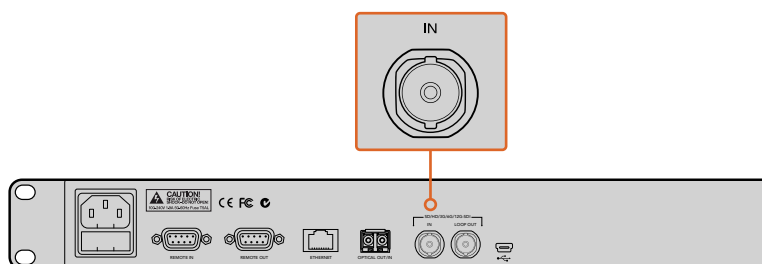

Conecte o seu vídeo de origem ao SDI no conector. O áudio é embutido no sinal de vídeo SDI.

O seu Blackmagic Duplicator 4K é compatível com 2 canais de áudio SDI embutido, portanto você não precisa conectar áudio, ele já está conectado através da entrada de vídeo SDI.

DICA Você pode monitorar os níveis de áudio do vídeo de origem na tela inicial no LCD.

Interligação em cascata

Você pode montar múltiplas unidades Blackmagic Duplicator 4K em cascata para gravar em um número ainda maior de cartões SD. Por exemplo, para duplicar 100 cartões, basta montar 4 unidades juntas em cascata.

- 1 Conecte a saída RS-422 remota, “Remote Out”, do primeiro Blackmagic Duplicator 4K à entrada remota, “Remote In”, na segunda unidade. Repita esse processo com cada unidade na cascata.
- 2 Igualmente, conecte a saída SDI loop da primeira unidade à entrada SDI da segunda unidade e repita o processo com cada unidade na cascata.
- 3 No painel de controle de cada unidade há um botão marcado REM. Este é o botão “Remote”, ele precisa ser ativado para habilitar o controle remoto entre as unidades. Pressione os botões “Remote” em cada Blackmagic Duplicator 4K da segunda unidade descendo pela cascata.

OBSERVAÇÃO Certifique-se de que a primeira unidade possua o botão “Remote” desativado, pois este será o Blackmagic Duplicator 4K responsável pelo controle de todos os outros na cascata. Esta primeira unidade, com o botão “Remote” desativado, é a unidade mestre e qualquer botão pressionado no seu painel frontal será transmitido da saída remota, a qual controla as unidades downstream com os botões “Remote” ativados. Qualquer produto televisivo com controle de deck RS-422 pode funcionar como a unidade mestre, pois o protocolo remoto é simplesmente o formato do controle de deck padrão.

Agora, todos os Blackmagic Duplicator 4K em cascata estão prontos para seguir o comando da primeira unidade.

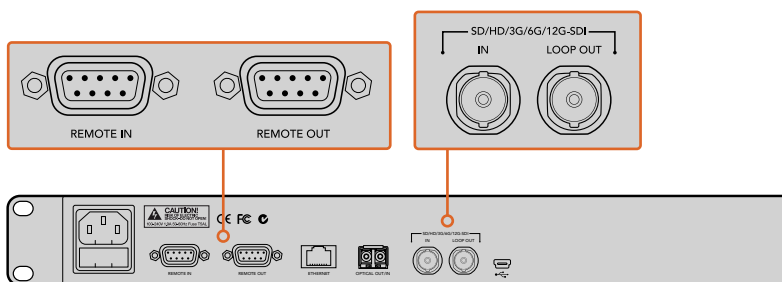

Os conectores “Remote” e “Loop” são usados para múltiplos Blackmagic Duplicator 4K montados em cascata. O conector loop na última unidade na cascata também pode ser usado para fazer o loop do vídeo de origem para outro equipamento, como um monitor Blackmagic SmartView ou um gravador HyperDeck.

Para informações mais detalhadas sobre a montagem de múltiplas unidades em cascata, consulte a seção ‘Interligação de múltiplos duplicadores em cascata’.

Inserção e formatação de cartões SD

O Blackmagic Duplicator 4K utiliza cartões SD classe 10 comuns para que você não precise comprar os cartões mais rápidos disponíveis. Os cartões SD podem ser adquiridos em qualquer loja de equipamentos de câmera e são até vendidos em alguns supermercados.

DICA No rótulo de todos os cartões SD, você encontrará um número de 1 a 10 impresso dentro de um círculo pequeno. Este número representa a classificação de velocidade do cartão e 10 é a classificação mais rápida. Qualquer cartão que tenha o número 10 impresso no círculo é um cartão SD classe 10 e o tipo de cartão necessário para gravar vídeos em até Ultra HD na configuração de taxa de bit mais elevada.

Como inserir um cartão SD:

- 1 Segure o cartão com os conectores dourados virados para o painel de controle e tela LCD e o alinhe a um dos compartimentos para cartão SD do Blackmagic Duplicator 4K.
- 2 Empurre delicadamente o cartão para dentro do compartimento até que esteja firmemente encaixado. O seu Blackmagic Duplicator 4K verificará o cartão rapidamente e quando ele estiver pronto para gravação, o LED de status acima do compartimento ficará verde.

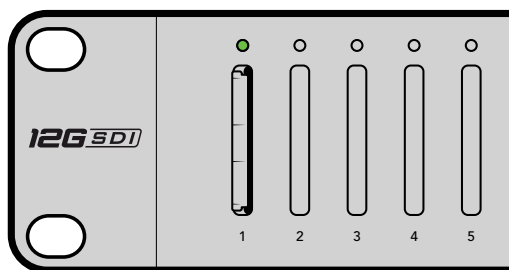
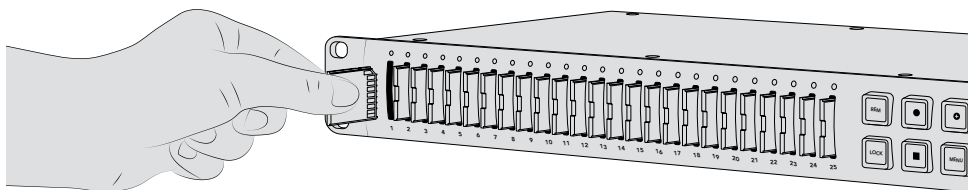

Alinhe o cartão SD com os conectores dourados virados para a tela LCD e o empurre delicadamente para dentro do compartimento até que esteja firmemente encaixado. O indicador LED de status fica verde quando o cartão está pronto para gravação.

Para remover um cartão, basta segurá-lo na sua extremidade e retirá-lo do compartimento.

DICA Ao inserir um cartão, certifique-se de que ele não esteja protegido contra gravação. A proteção contra gravação é desativada movendo a chave plástica na lateral esquerda do cartão para a posição mais próxima dos conectores. Depois da gravação, você pode então proteger o cartão contra gravação deslizando a chave de volta para a posição anterior.

Formatar Cartões SD

Antes de começar a gravação, você precisará formatar seus cartões SD em exFAT. Este formato é compatível tanto nos computadores macOS quanto Windows. É bem simples formatar as suas mídias usando o recurso “Format” do Blackmagic Duplicator 4K e ele pode ser usado para formatar até 25 cartões simultaneamente em uma única unidade.

Para formatar seus cartões SD no Blackmagic Duplicator 4K:

- 1 Pressione o botão “Menu” no painel de controle.
- 2 Com os botões funcionais de menu iluminados em cada lado do LCD, pressione “Record”.
- 3 Pressione o botão funcional da seta esquerda para selecionar a configuração “Format Cards” e depois pressione “Format” no canto inferior direito do menu LCD.
- 4 Uma mensagem de aviso aparecerá solicitando a confirmação do formato. Pressione o botão funcional “Format” para confirmar o formato ou pressione “Cancelar” para interromper.
- 5 Uma barra de progresso indicará o progresso da formatação. Quando a formatação estiver concluída, pressione “OK”.
- 6 Pressione o botão “Menu” no painel de controle para retornar à tela inicial.

Agora você já está pronto para começar. Com o seu vídeo e áudio conectados e seus cartões SD formatados, basta iniciar a gravação!

DICA A velocidade de formatação pode variar de acordo com o tipo e tamanho dos cartões SD, portanto alguns cartões concluirão a formatação mais rapidamente que outros.

Gravação

Você pode começar a gravação imediatamente pressionando o botão de gravação no painel de controle. No entanto, recomendamos primeiro a configuração do modo de gravação, do codec e da taxa de bit, pois eles determinam o tipo de gravação usada além da duração e qualidade.

Configuração de modos de gravação

O Blackmagic Duplicator 4K oferece os modos de gravação a seguir:

- **Duplicate:** grava em todos os cartões SD simultaneamente.
- **Single Disk:** grava em um cartão SD de cada vez em ordem e interrompe a gravação quando o último cartão fica cheio.
- **Single Disk Overwrite:** grava em um cartão SD de cada vez em ordem e sobrescreve em loop contínuo.

Modo Duplicate

No modo “Duplicate”, o Blackmagic Duplicator 4K grava o mesmo vídeo em todos os cartões SD ao mesmo tempo.

Modo Single Disk

O Blackmagic Duplicator 4K é o gravador ideal para registros em log com uma grande variedade de aplicativos, desde transmissão televisiva até câmeras de segurança. Ele grava em um compartimento SD de cada vez e, quando o cartão SD fica cheio, ele continua no próximo compartimento. No modo “Single Disk”, o Blackmagic Duplicator 4K interrompe a gravação quando todos os cartões SD ficam cheios. Com 25 compartimentos de gravação disponíveis, é possível gravar facilmente por uma semana. Para gravações contínuas e ininterruptas, você pode trocar os cartões cheios por cartões vazios a qualquer momento.

Se tiver múltiplos duplicadores juntos montados em cascata, você pode gravar por mais tempo ainda. Assim que todos os cartões na unidade mestre ficarem cheios, a gravação continuará na primeira unidade subordinada por todas as unidades conectadas na cascata. A gravação será interrompida no último cartão quando a última unidade ficar cheia.

Modo Single Disk Overwrite

O modo “Single Disk Overwrite” permite que um único Blackmagic Duplicator 4K com dois ou mais cartões SD retorne em loop ao primeiro cartão para gravação contínua quando o último cartão estiver cheio.

Este modo é semelhante ao modo “Single Disk”, com a diferença de que a a formatação e a gravação ocorrem no próximo cartão em loop, em vez de serem interrompidas quando o último cartão é preenchido. No modo “Single Disk Overwrite”, o Blackmagic Duplicator 4K manterá a gravação indefinidamente até que você pressione o botão “Parar”.

DICA Se estiver gravando no modo “Single Disk” ou “Single Disk Overwrite”, você pode inserir novos cartões SD com espaço em qualquer momento. O Duplicator 4K continuará a gravação enquanto houver cartões em qualquer um dos 25 compartimentos com espaço livre para gravação.

Como configurar um modo de gravação:

- 1 Ligue o Blackmagic Duplicator 4K.
- 2 Pressione o botão “Menu” no painel de controle frontal para abrir o menu LCD. Os botões funcionais próximos à tela ficam acesos para identificação das opções no menu. Pressione o botão funcional “Record”.

O menu de gravação possui pontos na parte inferior da tela indicando o número de opções disponíveis. Se quiser acessar o nível anterior na hierarquia do menu a qualquer momento, pressione o botão “Back”. Use os botões < e > para navegar pelas opções.
- 3 Navegue até a opção “Mode” e clique em “Change”.
- 4 Pressione o botão “Select” para usar o modo indicado. O menu LCD indica a opção selecionada.
- 5 Pressione o botão “Back” para retornar ao menu de gravação. A opção selecionada agora será exibida.

Para mais informações sobre a montagem de múltiplos duplicadores em cascata, consulte as seções “Montar em Cascata” e “Montar Múltiplos Duplicadores em Cascata”.

DICA Se um evento importante estiver sendo gravado no modo “Single Disk” ou “Single Disk Overwrite” e você quiser remover o cartão SD sem ter que esperar que ele fique cheio, basta pressionar e segurar o botão “Record” por três segundos para mudar a gravação para o próximo cartão SD. Quando estiver gravando no modo “Duplicate”, você pode pressionar o botão “Append Record”. Para mais informações, consulte a seção ‘Anexar Gravação’.

Configuração de codecs

O seu Blackmagic Duplicator 4K é capaz de gravar arquivos usando codecs de compressão H.264 ou H.265. A compressão H.264 é o codec padrão.

Como alterar o codec:

- 1 Pressione o botão "Menu".
- 2 Pressione o botão funcional "Record" para abrir as configurações de gravação.
- 3 Navegue pela configuração "Codec" usando os botões funcionais das setas e pressione "Change".
- 4 Use os botões funcionais das setas para selecionar o seu codec de preferência e, depois, pressione "Set" para confirmar a alteração, ou pressione o botão "Menu" no painel de controle para confirmar a alteração e retornar para a tela inicial no LCD.

OBSERVAÇÃO O seu Blackmagic Duplicator 4K deve ser atualizado para a versão de software 1.1 ou mais recente para alteração do codec. Para mais informações sobre atualizações de software, consulte a seção 'Utilitário Blackmagic Duplicator' neste manual.

Selecionando o Codec Correto

Para melhor compatibilidade, recomendamos usar o codec H.264. A razão pela qual fazemos esta recomendação é porque H.264 é o codec padrão para o Blackmagic Duplicator 4K.

O codec H.265 é excelente para vídeos Ultra HD de alta qualidade em tamanhos de arquivo menores, mas ainda é bastante recente e sua compatibilidade tende a ser mais limitada com computadores e equipamentos de reprodução.

Ambos os codecs possuem suas vantagens. Com H.265 você poderá usar cartões SD mais acessíveis, já que as taxas de bit e os tamanhos dos arquivos serão menores para determinadas qualidades de imagem. O codec H.264 é uma boa opção se compatibilidade for algo vital para o seu projeto.

Configuração de taxas de bit

As três configurações de taxas de bit no seu Blackmagic Duplicator 4K são "Low" (baixa), "Medium" (média) e "High" (alta). Elas permitem que você escolha a quantidade de dados gravados pelo codificador de vídeo para cada segundo de vídeo. A configuração padrão da taxa de bit é "Medium" para uma gravação de alta qualidade e um tamanho de arquivo mais viável. Porém, você pode alterar facilmente essa configuração no menu LCD.

Como alterar a configuração das taxas de bit:

- 1 Pressione o botão "Menu".
- 2 Pressione o botão funcional "Record" para abrir as configurações de gravação.
- 3 Navegue pela configuração "Bit Rate" usando os botões funcionais das setas e pressione "Change".
- 4 Use os botões funcionais das setas para selecionar a sua taxa de bit de preferência e, depois, pressione "Set" para confirmar a alteração, ou pressione o botão "Menu" no painel de controle para confirmar a alteração e retornar para a tela inicial no LCD.

OBSERVAÇÃO As taxas de bit mais elevadas resultam em gravações de maior qualidade, mas elas preenchem o cartão mais rapidamente ou requerem um cartão com mais espaço ou mais caro. A redução das taxas de dados aumenta o tempo de gravação no cartão, mas pode diminuir a qualidade da imagem de forma inferior à desejada.

Vale a pena fazer alguns testes usando configurações de taxas de bit diferentes para obter a qualidade de imagem adequada no menor tamanho de arquivo possível.

Gravar cliques

Para iniciar a gravação, basta pressionar o botão de gravação no painel de controle. Durante a gravação, os indicadores LED de status acima de cada compartimento ficarão vermelhos. Quando a gravação é interrompida, o indicador LED ficará verde indicando que a gravação foi bem-sucedida e o cartão está pronto para gravar outro clipe. Você pode facilmente verificar suas gravações em um computador através do seu compartimento ou leitor de cartão SD, ou em um televisor HDMI, caso ele seja compatível com cartões SD e o sistema de arquivo exFAT.

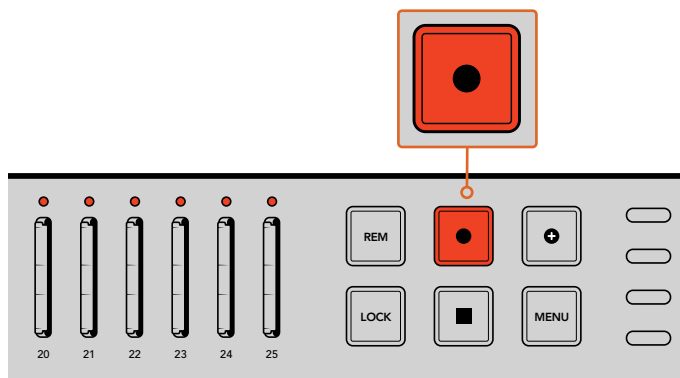

Pressione o botão "Record" para iniciar a gravação. Os LEDs de status acima de cada compartimento ficarão vermelhos indicando que os cartões SD estão gravando.

Indicadores LED de status

Os LEDs de status acima de cada compartimento de cartão SD acendem em cores diferentes para que você possa identificar o status do compartimento. Por exemplo, ao inserir um cartão SD, o LED do compartimento ficará verde quando o cartão for reconhecido e estiver pronto para gravação.

Uma descrição para cada cor, ação e status de LED está representada abaixo:



Verde Constante

Pronto para gravação. O LED ficará verde indicando que o cartão SD está pronto para gravação.



Vermelho constante

Gravando. O LED ficará vermelho enquanto um clipe estiver sendo gravado.



Vermelho piscante

Gravando e o cartão está quase cheio. O indicador piscará quando houver menos de 3 minutos de gravação disponíveis no cartão.



Vermelho piscando rapidamente

Descartando quadros. A velocidade de gravação do cartão SD não é rápida o suficiente para corresponder à velocidade de gravação do vídeo.



Amarelo constante

Cartão cheio, protegido contra gravação ou falha na gravação. Caso o LED acenda em amarelo constante durante a gravação, isso significa que o seu cartão SD pode conter falhas, está protegido contra gravação, ainda está desformatado ou tem menos de 10 segundos disponíveis. Você pode deslizar a chave de bloqueio para a posição de desbloqueio, "Unlock", reduzir a taxa de dados, usar um cartão SD mais rápido ou trocá-lo por um outro cartão.

Apesar do duplicador tentar manter o sistema de arquivo organizado em cada cartão e preparado no caso de um cartão ser removido durante a gravação, é importante que você não retire um cartão SD enquanto seu Blackmagic Duplicator 4K estiver gravando. Isto é devido a alguns sistemas operacionais com capacidade de identificar o cartão não serem tão robustos quanto outros e eles poderão identificar o cartão como danificado. Portanto, é mais seguro parar a gravação antes de retirar um cartão. Caso queira ter a capacidade de entregar cartões ao público antes de uma performance terminar, pode ser uma boa ideia usar muitos duplicadores e, assim, você pode parar uma unidade cedo para distribuir os cartões dela, enquanto as outras unidades continuam gravando.

DICA Embora cartões SD com uma classificação de velocidade classe 10 possam gravar utilizando todas as taxas de dados suportadas pelo Blackmagic Duplicator 4K, também é possível gravar a taxa de dados mais baixas usando cartões com uma classificação mais lenta, se necessário. Por exemplo, talvez você queira gravar uma câmera de segurança por durações prolongadas e não necessite de vídeo da mais alta qualidade. Recomendamos sempre fazer um teste de gravação para certificar que seu cartão SD possa gravar vídeos na taxa de bits selecionada. Para mais informações sobre a classificação de velocidade de cartões SD, consulte 'Inserção e formatação de cartões SD' na seção 'Instruções Preliminares'.

Anexar gravação

Ao gravar no modo de duplicação, talvez você queira gravar um novo clipe e adicioná-lo ao fim do clipe gravado anteriormente para que apareçam como um único clipe. Por exemplo, você poderia estar gravando uma performance com muitos eventos diferentes. Se você quiser gravar cada evento separadamente, mas combiná-los em um único clipe, é assim que o recurso "Anexar Gravação" pode ajudá-lo.

- 1 Grave o primeiro clipe como normalmente faria usando o botão de gravação. Pressione "Parar".
- 2 Quando o próximo evento começar, pressione o botão "Anexar Gravação". O botão acenderá junto com o botão de gravação padrão para indicar que você está gravando um clipe que será anexado ao clipe gravado anteriormente.
- 3 Pressione "Parar". O novo clipe será anexado ao primeiro clipe e ambos serão salvos como um único clipe.

DICA Ao usar o recurso de anexação de gravação, não há limite para o número de cliques subsequentes que podem ser anexados ao primeiro clipe. O tamanho do cartão e a duração das gravações é tudo que deve ser levado em consideração.

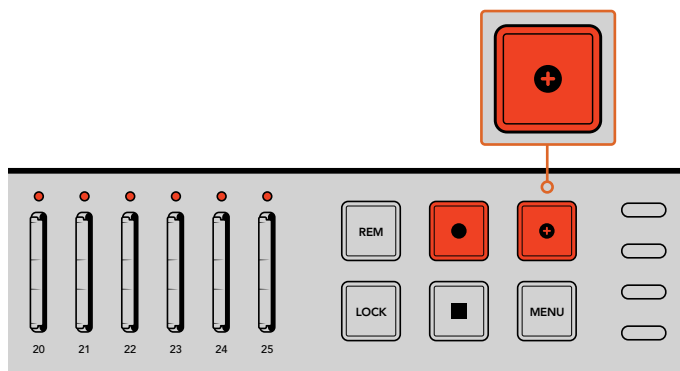

Pressione o botão "Anexar Gravação" para anexar um novo clipe ao clipe gravado anteriormente.

DICA Ao gravar no modo de gravação “Single Disk” ou “Single Disk Overwrite”, você pode pressionar e segurar o botão de gravação por três segundos para alternar a gravação para o próximo cartão, liberando o cartão atual. Isto é útil se você quiser acessar um evento importante imediatamente após seu acontecimento sem parar a gravação. Para mais informações sobre os modos de gravação de disco único e substituição de disco único, consulte a seção ‘Configuração de modos de gravação’. Quando estiver gravando no modo de duplicação, você pode pressionar o botão “Anexar Gravação”. Para mais informações, consulte a seção ‘Anexar Gravação’.

Bloquear o Blackmagic Duplicator 4K

Ao gravar um evento importante, você deve bloquear o painel de controle para que uma gravação não seja interrompida acidentalmente. Também é útil bloquear as unidades escravas interligadas em cascata para que os controles de uma delas não interrompam uma gravação acidentalmente.

O bloqueio é habilitado e desabilitado usando o botão “Lock” de cada unidade independentemente. Desbloquear uma unidade acidentalmente é muito improvável, já que você teria que segurar fisicamente o botão “Lock” por dois segundos em cada unidade para desbloquear os controles.

Como bloquear um Blackmagic Duplicator 4K:

- 1 Pressione o botão “Lock” no painel de controle do seu Blackmagic Duplicator 4K.
- 2 Para desbloquear a unidade, pressione e segure o botão “Lock”. Após dois segundos, a unidade será desbloqueada.

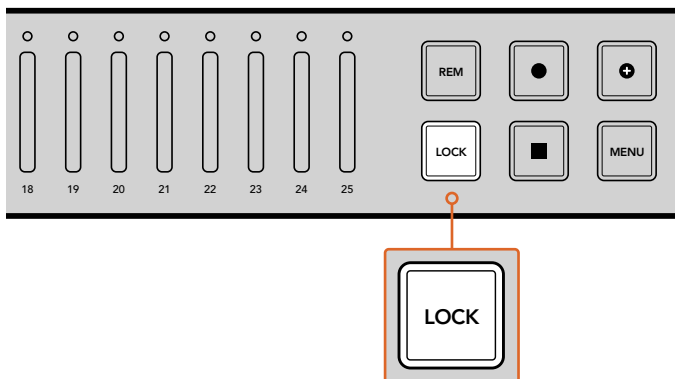

Bloquear o painel de controle do Blackmagic Duplicator 4K assegura que não há riscos de interromper uma gravação acidentalmente.

Interligação de múltiplos duplicadores em cascata

Caso seja necessário gravar em mais de 25 cartões SD, você pode interligar múltiplos modelos Blackmagic Duplicator 4K juntos em cascata. Ao interligar em cascata, eles compartilharão o mesmo sinal de vídeo através do conector SDI loop de cada unidade, além de se comunicarem entre si através dos conectores remotos usando o protocolo RS-422.

Como interligar múltiplos Blackmagic Duplicator 4Ks:

- 1 Conecte a porta RS-422 “Remote Out” da primeira unidade à porta “Remote In” da segunda unidade usando um cabo serial comum com conectores DB-9. Conectores DB-9 de cabos seriais são facilmente encontrados na sua loja de informática ou equipamentos de vídeo local.
- 2 Conecte a saída SDI loop da primeira unidade à entrada SDI da segunda unidade.

É fácil mesmo! Para interligar múltiplos Blackmagic Duplicator 4Ks em cascata, basta conectar cada saída “Remote” e “Loop” à entrada SDI e remota da próxima unidade ao longo de toda a cascata.

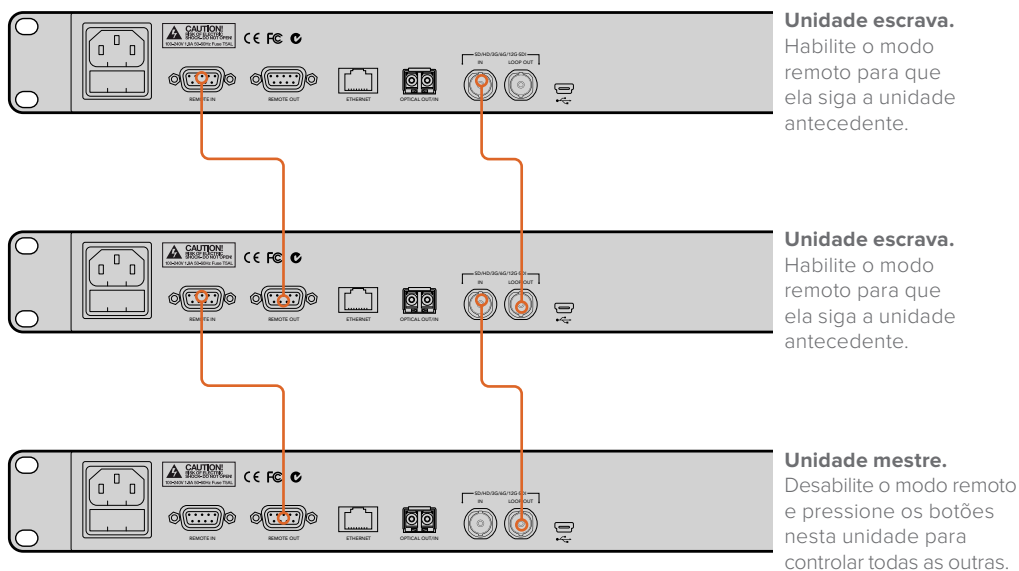

Para interligar múltiplos Blackmagic Duplicator 4K juntos, basta conectar a saída loop de uma unidade à entrada SDI da próxima unidade. Do mesmo modo, conecte a saída remota de uma unidade à entrada remota da próxima unidade.

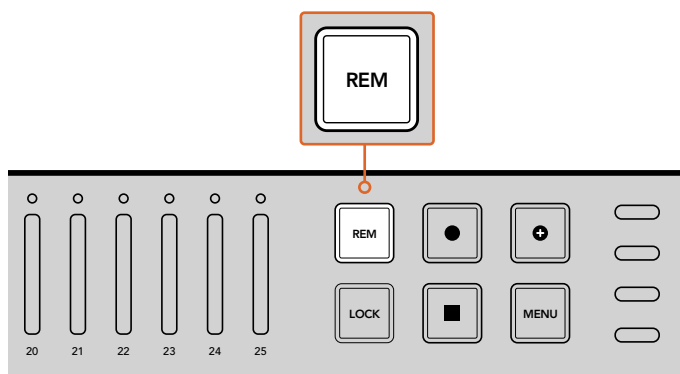

Pressione o botão “Remote” em cada unidade escrava na cadeia para que elas possam ser controladas eletronicamente pela primeira unidade.

OBSERVAÇÃO Certifique-se de manter pressionado o botão “Remote” no painel de controle de cada unidade escrava para habilitar o controle remoto. O botão “Remote” acenderá quando habilitado. Pressione novamente para desabilitá-lo.

É importante fazer um teste de gravação para assegurar que todas as unidades estejam sendo controladas pela unidade mestre antes da gravação final. Se as unidades escravas não estiverem se conformando à unidade mestre, verifique se a unidade mestre possui seu botão “Remote” apagado e as unidades escravas possuem seu botão “Remote” aceso.

Configurações do menu LCD

Todas as configurações do Blackmagic Duplicator 4K podem ser alteradas usando o menu LCD e os botões multifunção do painel de controle frontal. Os botões multifunção estão localizados acima de cada lateral do LCD e acenderão conforme as configurações exibidas no menu LCD.

Como alterar as configurações:

- 1 Pressione o botão “Menu” no painel de controle frontal para abrir as configurações de menu do LCD.
- 2 Utilize os botões multifunção do menu para a navegação.
- 3 Após ter selecionado sua configuração, pressione o botão multifunção “Change”.
- 4 Ajuste a configuração e pressione “Set” para confirmar a alteração.

A alteração pode ser sempre cancelada ao pressionar o botão “Back”, que retornará ao passo anterior na sequência do menu ou ao simplesmente pressionar o botão “Menu” do painel de controle, que retornará o LCD à sua tela inicial.

Record

As configurações “Record” possibilitam alterar a fonte de vídeo, definir a taxa de bit, habilitar ou desabilitar disparo de gravação e formatar cartões SD.

Video Source

Esta configuração é utilizada para selecionar entre a entrada SDI e a entrada de fibra óptica caso possua o módulo SDI de fibra óptica instalado.

Mode

Utilize esta configuração para selecionar um modo de gravação:

Duplicate

Grave o mesmo vídeo em todos os cartões SD ao mesmo tempo.

Single Disk

Grava em um cartão SD por vez, e quando o cartão é preenchido, continue no próximo cartão SD disponível. Quando todos os cartões são preenchidos, o Duplicator 4K encerra a gravação. Caso possua múltiplas unidades interligadas em cascata, a gravação continua no próximo Duplicator 4K até que todos os cartões SD sejam preenchidos.

Single Disk Overwrite

Grava em um loop contínuo. Grava em um cartão SD por vez, e quando o cartão é preenchido, continue no próximo cartão SD disponível. Quando todos os cartões estão cheios, o Duplicator 4K retorna ao primeiro cartão SD e continua a gravação.

Codec

Utilize esta configuração para definir o Blackmagic Duplicator 4K para gravar usando os codecs de compactação H.264 e H.265.

Abaixo está uma descrição dos dois codecs:

H.264

Compactação muito comumente usada oferecendo um bom meio-termo entre qualidade de imagem e tamanho de arquivo. A maioria dos dispositivos de reprodução da última década será capaz de identificar arquivos compactados com este codec até, pelo menos, a resolução HD.

H.265

Compactação altamente eficiente, capaz de reduzir o tamanho dos arquivos de vídeo pela metade para uma qualidade de imagem que se compara a H.264. Este codec é excelente para empacotamento de alta qualidade ou vídeos Ultra HD, mas pode necessitar de software e hardware de reprodução mais atualizado para ser reproduzido.

OBSERVAÇÃO Para mais informações sobre a diferença entre H.264 e H.265, consulte a seção 'Gravação' deste manual.

Bit Rate

A taxa de bit determina a quantidade vídeo a ser gravada nos seus cartões SD e a qualidade da gravação do vídeo. Há três opções de seleção.

High

Selecione "High" quando desejar a qualidade de vídeo mais alta com o mínimo de compactação.

Medium

Selecione a configuração "Medium" se desejar que mais vídeo caiba nos seus cartões SD, mas também quiser uma qualidade de imagem muito boa.

Baixa

Selecione "Low" se desejar que mais vídeo caiba nos seus cartões SD e não precisar da qualidade de imagem mais alta. Esta configuração utilizará mais compactação, portanto é possível que você veja artefatos de compressão visíveis na sua gravação.

OBSERVAÇÃO O codificados H.265 integrado utiliza a tecnologia de compressão mais atual, o que significa que você obtém gravações de vídeo de alta qualidade usando uma quantidade mínima de dados. Mesmo na sua configuração mais baixa, com o máximo de compressão de vídeo, a qualidade da sua gravação ainda será muito boa.

Taxas de Bit para Formatos de Vídeo

Ultra HD			
Formato de Vídeo	Configuração da Taxa de Bit	Taxa de Bit (Mb/s) H.264	Taxa de Bit (Mb/s) H.265
2160p60	High	75	50
	Medium	66	38
	Low	50	20
2160p59.94	High	75	50
	Medium	66	38
	Low	50	20

Ultra HD			
Formato de Vídeo	Configuração da Taxa de Bit	Taxa de Bit (Mb/s) H.264	Taxa de Bit (Mb/s) H.265
2160p50	High	72	48
	Medium	61	32
	Low	42	16
2160p30	High	50	30
	Medium	37	20
	Low	24	10
2160p29.97	High	50	30
	Medium	37	20
	Low	24	10
2160p25	High	40	25
	Medium	32	18
	Low	20	10
2160p24	High	40	25
	Medium	32	18
	Low	20	10
2160p23.98	High	40	25
	Medium	32	18
	Low	20	10

HD			
Formato de Vídeo	Configuração da Taxa de Bit	Taxa de Bit (Mb/s) H.264	Taxa de Bit (Mb/s) H.265
1080p60	High	40	20
	Medium	32	15
	Low	20	10
1080i60	High	40	20
	Medium	32	15
	Low	20	10
1080p59.94	High	40	20
	Medium	32	15
	Low	20	10
1080i59.94	High	40	20
	Medium	32	15
	Low	20	10
1080p50	High	36	20
	Medium	28	15
	Low	18	10

HD			
Formato de Vídeo	Configuração da Taxa de Bit	Taxa de Bit (Mb/s) H.264	Taxa de Bit (Mb/s) H.265
1080i50	High	36	20
	Medium	28	15
	Low	18	10
1080p30	High	28	15
	Medium	20	11
	Low	11	7
1080p29.97	High	28	15
	Medium	20	11
	Low	11	7
1080p25	High	24	15
	Medium	16	10
	Low	9	6
1080p24	High	24	15
	Medium	15	10
	Low	8	6
1080p23.98	High	24	15
	Medium	15	10
	Low	8	6
720p60	High	25	12
	Medium	17	10
	Low	9	8
720p59.94	High	25	12
	Medium	17	10
	Low	9	8
720p50	High	20	12
	Medium	14	9
	Low	7	6

SD			
Formato de Vídeo	Configuração da Taxa de Bit	Taxa de Bit (Mb/s) H.264	Taxa de Bit (Mb/s) H.265
625i50 PAL	High	18	11
	Medium	12	8
	Low	6	6
525i59.94 NTSC	High	20	12
	Medium	14	9
	Low	7	6

Trigger

A configuração “Trigger” habilita o recurso de disparo de gravação, que viabiliza gravações no Blackmagic Duplicator 4K com o disparo do botão de gravação em outros equipamentos SDI, por exemplo, uma Blackmagic URSA Mini.

None

Para desativar o disparador de gravação, selecione “None”.

SDI Start/Stop

Quando “SDI Start/Stop” é selecionado, o Blackmagic Duplicator 4K pode começar a gravar quando você pressiona o botão de gravação em outros equipamentos SDI.

Por exemplo, a Blackmagic URSA Mini sempre envia um sinal de disparo de gravação através das saídas SDI, portanto sempre que você pressionar o botão de gravação da câmera, o Blackmagic Duplicator 4K começará a gravar e cessará a gravação quando você pressionar o botão de gravação novamente. Você não precisa ajustar configurações para habilitar o recurso de disparo de gravação na URSA Mini, mas se estiver utilizando outros equipamentos com suporte a disparo de gravação e desejar disparar a gravação com este equipamento, será necessário habilitar o disparo de gravação “SDI Start/Stop” usando o menu de configurações do seu equipamento.

Timecode Run

Se o equipamento SDI não suportar disparos de gravação SDI iniciar/parar, você pode configurar o Blackmagic Duplicator 4K para iniciar a gravação assim que ele detectar um código de tempo em execução. Por exemplo, caso tenha uma câmera SDI conectada ao seu Blackmagic Duplicator 4K e a câmera estiver configurada como “Record Run”, ela irá disparar o Blackmagic Duplicator 4K para começar a gravar também. Quando você parar de gravar na sua câmera, o código de tempo cessará a execução e a gravação será encerrada no Blackmagic Duplicator 4K.

Este é um recurso excelente, mas será necessário assegurar que o código de tempo do seu equipamento esteja definido como “Record Run”. Se o código de tempo estiver configurado para hora do dia, ele continuará emitindo o código de tempo de execução e disparando a gravação no Blackmagic Duplicator 4K, o que é provavelmente indesejável.

Format Cards

Você pode formatar até 25 cartões simultaneamente usando o recurso de formatação no seu Blackmagic Duplicator 4K.

Como formatar seus cartões:

- 1** Pressione o botão “Menu” no painel de controle frontal para abrir as configurações de menu do LCD.
- 2** Pressione o botão multifunção “Record” para abrir as configurações de gravação.
- 3** Pressione os botões de seta esquerda ou direita para navegar até a configuração “Format Cards” e pressione “Format”.
- 4** Um aviso aparecerá solicitando a confirmação da formatação. Você também visualizará um alerta de que esta ação não pode ser desfeita. Caso tenha dados que deseja manter nos seus cartões SD, certifique-se de que tenha cópias de segurança antes de prosseguir com a ação.
- 5** Pressione “Format” para confirmar a ação. Você também pode pressionar “Cancel” e retornar às configurações de gravação.
- 6** Enquanto seus cartões estiverem sendo formatados, os indicadores LED piscarão em amarelo e uma barra de progresso aparecerá no LCD. Quando os cartões estiverem formatados, os indicadores de status permanecerão verdes e o menu LCD indicará que a formatação está concluída e os cartões prontos para a gravação.
- 7** Pressione “OK”. Pressione o botão “Menu” no painel de controle para retornar à tela inicial.

Settings

O menu “Settings” é utilizado para alterar as configurações de rede do Blackmagic Duplicator 4K, como habilitar ou desabilitar DHCP e configurações de endereço IP, máscara de sub-rede e gateway. Conectar seu Blackmagic Duplicator 4K a uma rede possibilita controlar a unidade remotamente usando um software de administração de terceiros, como Telnet.

DHCP ‘ON’

Para definir o Blackmagic Duplicator 4K para configurar automaticamente as melhores definições quando conectado a uma rede, selecione “On”. Isso significa que o Blackmagic Duplicator 4K verificará todos os dispositivos conectados a rede e definir seu endereço IP e outras configurações de rede para evitar quaisquer conflitos de configuração possíveis. Isto é muito confiável e uma maneira fácil de obter suas configurações de rede funcionando rapidamente.

DHCP ‘OFF’

Caso queira controlar toda a sua rede manualmente, você pode inserir os detalhes manualmente ao desabilitar DHCP e navegar até as configurações para alterar o endereço IP, máscara de sub-rede e gateway.

IP Address, Subnet Mask e Gateway

Quando DHCP está desabilitado, você pode alterar essas configurações manualmente.

Como editar os campos de número:

- 1 Selecione o campo de número que deseja alterar usando os botões multifunção esquerdo ou direito do menu e pressione “Change”.
- 2 Pressione os botões esquerdo e direito do menu para aumentar ou diminuir o valor do número. Você também pode manter o botão pressionado para configurar mais rapidamente.
- 3 Pressione “Set” para confirmar a alteração.

Agora, você pode usar os botões multifunção para navegar pelo resto da sequência e fazer os ajustes necessários.



O menu de configurações LCD possibilita alterar as configurações de rede para que você possa controlar seu Blackmagic Duplicator 4K usando um software de administração de terceiros, como Telnet.

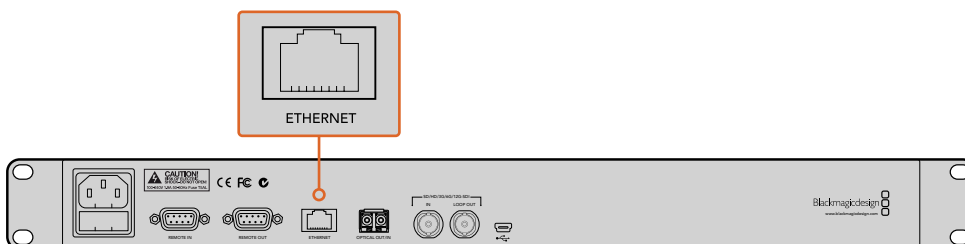

Conecte seu Blackmagic Duplicator 4K à sua rede através da porta Ethernet do painel traseiro.

About

Esta configuração de menu oferece uma visão geral instantânea que exibe a configuração da taxa de bit atual, nome de arquivo da gravação mais recente, status da rede e a versão do software interno do Blackmagic Duplicator 4K.

Utilitário Blackmagic Duplicator

Atualização do Blackmagic Duplicator 4K

O utilitário de software Blackmagic Duplicator é utilizado para atualizar o software interno do seu Blackmagic Duplicator 4K e alterar a configuração do prefixo de nome de arquivo para que você possa rotular suas gravações. Recomendamos baixar o software e atualizar o seu Blackmagic Duplicator 4K para que possa tirar proveito de recursos e aprimoramentos novos.

Você pode baixar a última versão na Central de Suporte Técnico da Blackmagic Design em www.blackmagicdesign.com/support/br.

Como atualizar o software interno usando macOS:

- 1 Baixe e descompacte o utilitário Blackmagic Duplicator.
- 2 Abra a imagem de disco resultante e inicie o instalador Blackmagic Video Assist Setup. Siga as instruções na tela.
- 3 Após instalar o utilitário Blackmagic Duplicator mais recente, conecte um cabo USB do Blackmagic Duplicator 4K ao seu computador.
- 4 Inicie o utilitário Blackmagic Duplicator e abra as configurações ao clicar no ícone circular de configurações. Se o software detectar uma versão anterior instalada no seu Blackmagic Duplicator 4K, ele exibirá um ícone de atualização imediata "Update Now". Basta clicar no ícone para atualizar o software interno. Caso o Blackmagic Duplicator 4K tenha o software interno mais recente instalado, não é necessário fazer mais nada.

Como atualizar o software interno usando Windows:

- 1 Baixe e descompacte o utilitário Blackmagic Duplicator.
- 2 Você deve visualizar uma pasta Blackmagic Duplicator Utility contendo este manual e o instalador do utilitário Blackmagic Duplicator. Dê um clique duplo no instalador e siga as orientações na tela para concluir a instalação.
- 3 Após instalar o utilitário Blackmagic Duplicator mais recente, conecte um cabo USB do Blackmagic Duplicator 4K ao seu computador.
- 4 Inicie o utilitário Blackmagic Duplicator e abra as configurações ao clicar no ícone circular de configurações. Se o software detectar uma versão anterior instalada no seu Blackmagic Duplicator 4K, ele exibirá um ícone de atualização imediata "Update Now". Basta clicar no ícone para atualizar o software interno. Caso o Blackmagic Duplicator 4K tenha o software interno mais recente instalado, não é necessário fazer mais nada.

Prefixo do nome de arquivo

Você pode alterar o prefixo do nome de arquivo para que suas gravações possam ser rotuladas e facilmente identificadas. Basta clicar na caixa de edição "File Name Prefix" e digitar um novo nome. Agora, quando seu Blackmagic Duplicator 4K gravar o próximo clipe, seu nome de arquivo será personalizado e seguido de quatro dígitos para identificar o número do clipe. Esses dígitos serão incrementados com cada clipe gravado.

Você também pode assegurar que as gravações nas unidades interligadas em cascatas utilizem o mesmo nome de arquivo ao habilitar os botões “Remote” nas unidades escravas e alterar a configuração do prefixo do nome de arquivo na unidade mestre. Isto possibilita gravar cliques e que todos os cartões em todas as unidades compartilhem o mesmo nome de arquivo.

Instalação do módulo de fibra óptica SDI opcional

Caso deseje conectar vídeos SDI via fibra óptica, será necessário instalar o módulo de fibra óptica SDI opcional. Qualquer módulo SFP de fibra óptica compatível com SMPTE pode ser instalado e adquirido separadamente de qualquer revendedor Blackmagic Design. O módulo simplesmente se encaixa à gaiola de fibra óptica no painel traseiro do Blackmagic Duplicator 4K. Com o módulo de fibra óptica SDI instalado, você pode conectar vídeos SDI com áudio embutido com cabos de extensão extremamente longos. Também é possível utilizar a saída óptica como um conector loop de vídeo adicional.

Se estiver operando em sistemas de fibra óptica de velocidade mais baixa, como fibra óptica 3G-SDI ou 6G-SDI, você pode instalar um módulo mais lento nesse compartimento para reduzir custos se não precisar das velocidades mais altas.

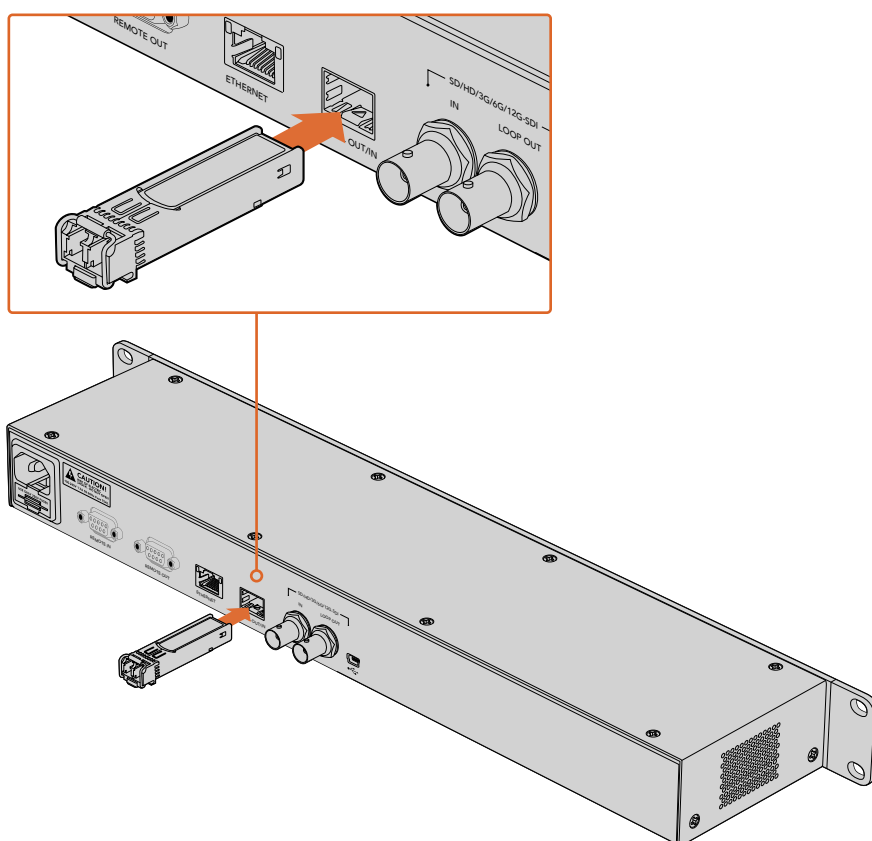

Você também pode conectar vídeos SDI através de fibra óptica ao instalar o módulo de fibra óptica SDI opcional.

O Blackmagic Duplicator 4K utilizará qualquer um dos conectores de vídeo plugados primeiro, mas caso possua SDI e fibra óptica conectados, é possível selecionar entre eles usando a configuração “Video Source” no menu LCD. Consulte a seção ‘Configurações’ para mais informações.

Controle RS-422

O que é controle RS-422?

O padrão RS-422 é uma especificação de controle serial de deck profissional. Ele é usado por teledifusores desde o início dos anos 80 e encontrado em diversos decks, editores lineares, editores não lineares e produtos de automação profissionais. Seu Blackmagic Duplicator 4K oferece suporte a esse padrão para que possa ser integrado a sistemas de automação e controle remoto profissionais, sistemas de gravação agendada e qualquer tipo de controle personalizado que você mesmo deseje desenvolver.

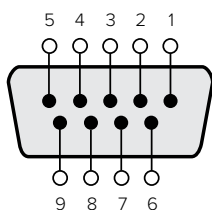

Transmit (-)	Transmit (+)	Receive (-)	Receive (+)	Pinos de Aterramento
2	7	8	3	1, 4, 6, 9

Conexões de pino do modo remoto RS-422 para os conector da entrada remota.

Como usar um controlador RS-422 externo

O Blackmagic Duplicator 4K inclui uma porta de controle de deck remota RS-422 compatível com padrão de indústria Sony(tm), que inclui as conexões de pino corretas para a conexão direta a qualquer controlador remoto com RS-422.

Você pode usar cabos pré-fabricados de 9 pinos, desde que cada extremidade do cabo seja conectada “pino a pino”, ou seja, com os mesmos números de pino interligados em cada extremidade do cabo. Se o seu equipamento for conectado de forma diferente e desejar criar cabos personalizados, consulte o diagrama elétrico da entrada remota incluído para que possa assegurar que os pinos de transmissão, ou Tx, estejam conectados aos pinos receptores, ou Rx.

Ao conectar um controlador RS-422 externo ao Blackmagic Duplicator 4K, você pode controlar a unidade remotamente em vez de apertar os botões localmente.

- 1 Conecte um cabo RS-422 do seu controlador externo à entrada remota do Blackmagic Duplicator 4K.
- 2 Pressione o botão marcado “Rem” no painel de controle do Blackmagic Duplicator 4K para habilitar o controle de deck remoto.

Agora, você pode iniciar e parar gravações, ou iniciar e parar um anexo de gravação com seu Blackmagic Duplicator 4K remotamente. Confira a lista completa de comandos RS-422 suportados na próxima seção ‘Comandos RS-422 suportados’.

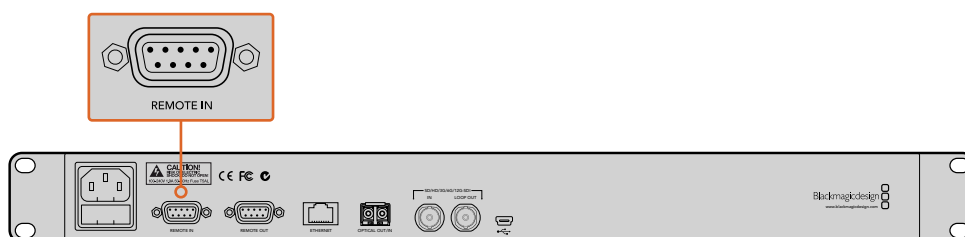

Conecte um controlador RS-422 externo à entrada remota do Blackmagic Duplicator 4K para controlar a unidade remotamente.

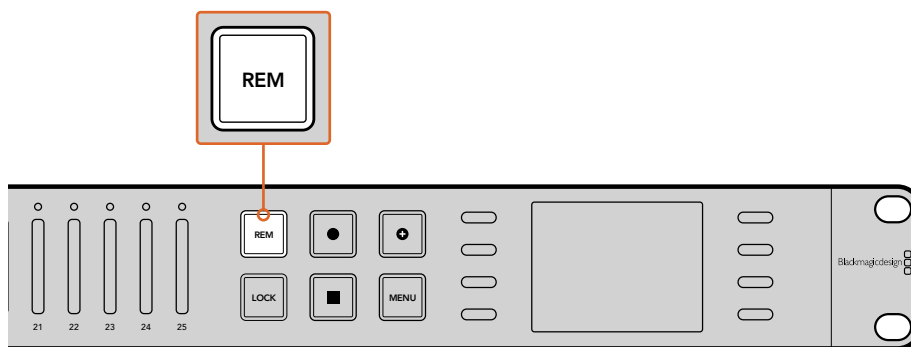

Pressione o botão marcado "Rem" no painel de controle do Blackmagic Duplicator 4K para habilitar o controle de deck RS-422.

Comandos RS-422 Suportados

		Comando	Resposta	Não Remoto	Notas
0 - System Control					
0x00	0x11	DeviceTypeRequest	NTSC: 0xF0E0 PAL: 0xF1E0 24P: 0xF2E0	Enabled	–

1 - Resposta do Escravo					
= 0x20	0x00	Parar	Confirmar	Desabilitado	–
= 0x20	= 0x02	Gravar	Confirmar	Desabilitado	–
0x21	= 0x02	Anexar	Confirmar	Desabilitado	Comando não-padrão - uma carga adicional de 0x00 indica anexar

4 - Predefinição/Seleção de Controle					
0x40	0x40	Modo Automático Inativo	Confirmar	Desabilitado	ignorado, status de bit memorizado
0x40	0x41	Modo Automático Ativo	Confirmar	Desabilitado	ignorado, status de bit memorizado
0x61	0x20	StatusSense	StatusData	Habilitado	–

7 - Sense Reply					
0x70	= 0x20	StatusData	–	–	Confira a tabela "Status Bits": Limitada a 9 bytes de status, truncados silenciosamente

Informações para desenvolvedores RS-422

	Bit 7	Bit 6	Bit 5	Bit 4	Bit 3	Bit 2	Bit 1	Bit 0
Byte 0	0	0	Cassette out	0	0	0	0	Local
Byte 1	Standby	0	Stop	0	0	0	Record	0
Byte 2	0	0	0	0	0	0	0	0
Byte 3	Auto Mode	0	0	0	0	0	0	0
Byte 4	Select EE	Full EE	0	0	0	0	0	0
Byte 5	0	0	0	0	0	0	0	0
Byte 6	0	0	0	0	0	0	0	0
Byte 7	0	0	0	0	0	0	0	0
Byte 8	0	0	0	0	0	0	0	0
Byte 9	0	0	0	0	0	0	0	0

Variáveis	
Cassette Out	Definir se não houver cartões prontos para gravar.
Local	Definir se no modo local (sem controle remoto)
Standby	Definir se um ou mais cartões estiverem prontos para gravar.
Auto Mode	Apenas para compatibilidade.
Full EE	Apenas para compatibilidade - sempre habilitado.
Select EE	Apenas para compatibilidade - sempre habilitado.

Configurações RS-422 Blackmagic Duplicator 4K	
Protocolo	Baseado no protocolo Sony de 9 pinos.
Taxa Baud	38.4 K
Bits de Inicialização	1
Bits de Dados	8
Bits de Finalização	1
Bits de Paridade	1
Tipo de Paridade	Ímpar

Controle Remoto via Ethernet

O Blackmagic Duplicator 4K pode ser controlado externamente via Ethernet usando comandos baseados em texto do Blackmagic HyperDeck Ethernet Protocol. Isso oferece a capacidade de controlar seu Blackmagic Duplicator 4K remotamente de um computador utilizando um software de administração, como Telnet, ou você pode criar seu próprio painel hardware de controle e programá-lo para se integrar ao Blackmagic Duplicator 4K usando o HyperDeck Ethernet Protocol.

Você pode desenvolver suas próprias soluções personalizadas para controlar seu duplicador a partir de computadores, dispositivos de controle hardware dedicados ou sistemas de grande porte utilizados em estúdios profissionais ou caminhões de transmissão. Por exemplo, microcontroladores Arduino são pequenas placas de circuito que podem ser personalizadas com placas de expansão chamadas “shields”. Há diversos tipos de shields e podem alojar conectores diferentes. Para controlar seu Blackmagic Duplicator 4K, um shield de Ethernet é necessário. Você pode até comprar shields adicionais com botões programáveis. Os microcontroladores Arduino são fáceis de configurar, muito acessíveis com código completamente aberto. Após programar o software Arduino, basta conectar o Arduino à porta de Ethernet do Blackmagic Duplicator 4K e iniciar o controle imediato do seu duplicador.

Exemplo de controle via um Arduino

Os microcontroladores Arduino são programados usando a linguagem de programação C comum. Basta programar seu controlador para disparar comandos ao seu Blackmagic Duplicator 4K usando o HyperDeck Ethernet Protocol. Todos os comandos suportados são demonstrados na seção ‘Blackmagic HyperDeck Ethernet Protocol’ abaixo.

Você pode adicionar outros shields de expansão ao seu Arduino para que possa desempenhar diversas funções de gravação. Por exemplo, ao adicionar um relógio interno, você pode programar seu controlador para instruir o Blackmagic Duplicator 4K a gravar em horários específicos do dia, o que pode ser útil se estiver agendando gravações de segurança.

Estamos animados com essa tecnologia e gostaríamos de saber mais sobre os controles de Ethernet externos que você criar!

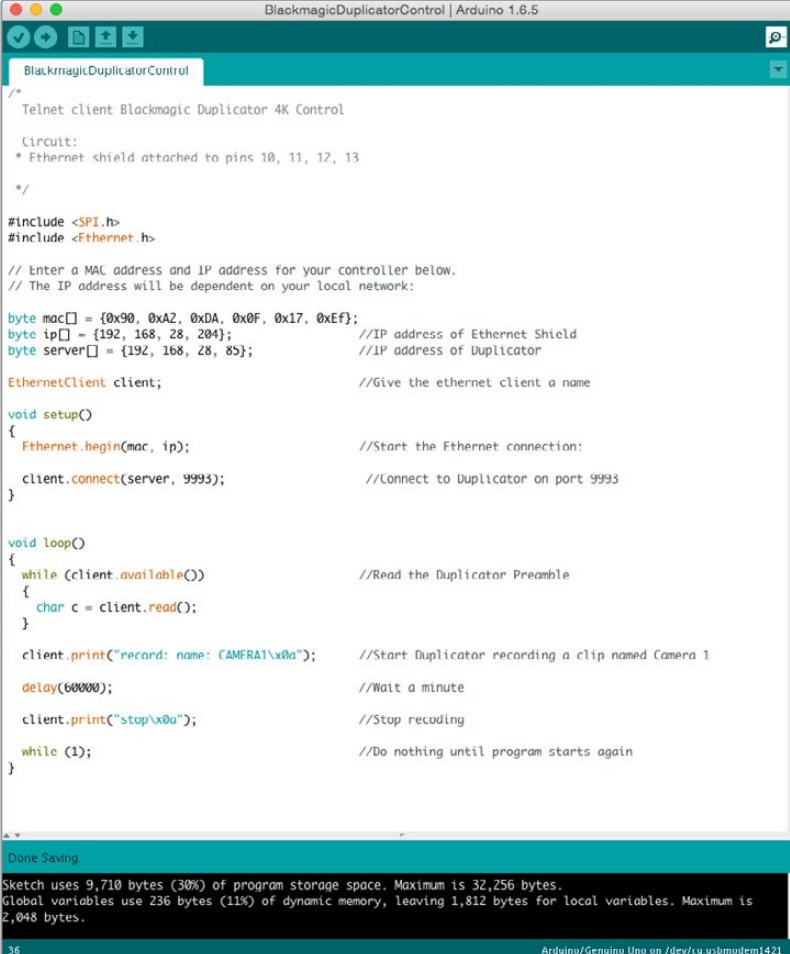

```
BlackmagicDuplicatorControl | Arduino 1.6.5
BlackmagicDuplicatorControl
/*
  Telnet client Blackmagic Duplicator 4K Control

  Circuit:
  * Ethernet shield attached to pins 10, 11, 12, 13
  */

#include <SPI.h>
#include <Ethernet.h>

// Enter a MAC address and IP address for your controller below.
// The IP address will be dependent on your local network:

byte mac[] = {0x90, 0xA2, 0xDA, 0x0F, 0x17, 0xEF};
byte ip[] = {192, 168, 28, 204}; //IP address of Ethernet Shield
byte server[] = {192, 168, 28, 85}; //IP address of Duplicator

EthernetClient client; //Give the ethernet client a name

void setup()
{
  Ethernet.begin(mac, ip); //Start the Ethernet connection:
  client.connect(server, 9993); //Connect to Duplicator on port 9993
}

void loop()
{
  while (client.available()) //Read the Duplicator Preamble
  {
    char c = client.read();
  }

  client.print("record: name: CAMERA1\r\n"); //Start Duplicator recording a clip named Camera 1
  delay(60000); //Wait a minute
  client.print("stop\r\n"); //Stop recoding
  while (1); //Do nothing until program starts again
}

Done Saving.
Sketch uses 9,710 bytes (30%) of program storage space. Maximum is 32,256 bytes.
Global variables use 236 bytes (11%) of dynamic memory, leaving 1,812 bytes for local variables. Maximum is 2,048 bytes.
36 Arduino/Genuino Uno an /dev/cu.usbmodem1421
```

Ao programar um controlador de Ethernet externo, como neste exemplo usando um Arduino com um shield de Ethernet, basta usar o protocolo de Ethernet de referência aqui para selecionar quais comandos necessita usar para obter o controle desejado.

O código demonstrado na janela acima também é demonstrado na página abaixo para que você possa copiar e colar no seu IDE Arduino. O código programa o Arduino a instruir o Blackmagic Duplicator 4K para gravar por um minuto, parar a gravação e esperar até que o programa seja executado novamente.

```
/*
   Telnet client Blackmagic Duplicator 4K Control Circuit: *
Ethernet shield attached to pins 10, 11, 12, 13
*/
#include <SPI.h>
#include <Ethernet.h>
// Enter a MAC address and IP address for your controller below.
// The IP address will be dependent on your local network:
byte mac[] = {0x90, 0xA2, 0xDA, 0x0F, 0x17, 0xEF};
byte ip[] = {192, 168, 28, 204};      // IP address of Ethernet Shield
byte server[] = {192, 168, 28, 141};  // IP address of Duplicator
EthernetClient client;                // Give the ethernet client a name

void setup()
{
  Ethernet.begin(mac, ip); //Start the Ethernet connection:

  client.connect(server, 9993);      //Connect to Duplicator on port 9993
}

void loop()
{
  while (client.available()) //Read the Duplicator Preamble
  {
    char c = client.read();
  }
  client.print("record: name: Camera1\x0a");
  //Start Duplicator recording a clip named Camera 1
  delay(60000);                      //Wait a minute
  client.print("stop\x0a");          //Stop recoding
  while (1);                          //Do nothing until program starts again
}
```

Blackmagic HyperDeck Ethernet Protocol

O Blackmagic HyperDeck Ethernet Protocol é um protocolo baseado em texto que foi originalmente escrito para controlar os gravadores de disco HyperDeck através da porta Ethernet, mas você pode utilizar o mesmo protocolo para controlar o Blackmagic Duplicator 4K.

Como o duplicador apenas grava, ele não possui o conjunto de comandos completo do protocolo HyperDeck, mas esta seção demonstra os comandos disponíveis relevantes ao usar o protocolo de Ethernet HyperDeck no duplicador.

Protocolo de Comandos (em inglês)

Comando	Descrição do Comando
help or ?	Provides help text on all commands and parameters
remote	Queries the state of HyperDeck's remote control mode.
remote: enable: true	Enables remote control.
remote: enable: false	Disables remote control.
remote: override: true	Turns remote override on.
remote: override: false	Turns remote override off.
quit	Disconnects HyperDeck server.
ping	Determines HyperDeck server is responding.
record	Starts recording.
record: append: true	Starts appended recording.
stop	Stops playback or recording.
commands	Lists all supported commands in an XML format.
notify	Queries the current state of all notifications.
notify: transport: true	Enables transport notifications.
notify: transport: false	Disables transport notifications.
notify: slot: true	Enables slot notifications.
notify: slot: false	Disables slot notifications.
notify: remote: true	Enables remote notifications.
notify: remote: false	Disables remote notifications.
notify: configuration: true	Enables configuration notifications.
notify: configuration: false	Disables configuration notifications.
notify: dropped frames: true	Enables dropped frames notifications.
notify: dropped frames: false	Disables dropped frames notifications.
device info	Provides device information.
slot info: slot id: {slot ID}	Provides information about a specified slot.
transport info	Provides information for the state of the transport.
configuration	Queries the current configuration.
configuration: record mode: Duplicate	Configures the record mode to duplicate.
configuration: record mode: SingleDisk	Configures the record mode to single disk.

Comando	Descrição do Comando
configuration: record mode: DiskOverwrite	Configures the record mode to disk overwrite.
configuration: video input: ["SDI", "optical"]	Configures video input.
configuration: file format: {format}	Configures the record codec and bit rate.
format: prepare: {format}	prepare a disk formatting operation to filesystem {format}
format: confirm: {token}	perform a pre-prepared formatting operation using token
watchdog: period: {seconds}	Configures the watchdog.

Como usar XML

Embora você utilize o Terminal para se comunicar com o HyperDeck, se você estiver programando software poderá usar XML para confirmar a existência de um comando específico baseado no firmware do HyperDeck com o qual está se comunicando. Isso ajuda a interface de usuário do seu software a se ajustar às capacidades do modelo HyperDeck específico e da versão do software.

Detalhes do Protocolo (em inglês)

Connection

The HyperDeck Ethernet server listens on TCP port 9993.

Basic syntax

The HyperDeck protocol is a line oriented text protocol. Lines from the server will be separated by an ASCII CR LF sequence. Messages from the client may be separated by LF or CR LF.

New lines are represented in this document as a "`\n`" symbol.

Command syntax

Command parameters are usually optional. A command with no parameters is terminated with a new line:

```
{Command name}\n
```

If parameters are specified, the command name is followed by a colon, then pairs of parameter names and values. Each parameter name is terminated with a colon character:

```
{Command name}: Parameter {Value} {Parameter}: {Value} ...\n
```

Response syntax

Simple responses from the server consist of a three digit response code and descriptive text terminated by a new line:

```
{Response code} {Response text}\n
```

If a response carries parameters, the response text is terminated with a colon, and parameter name and value pairs follow on subsequent lines until a blank line is returned:

```
{Response code} {Response text}:\n
```

```
{Parameter}: {Value}\n
```

```
{Parameter}: {Value}\n
```

```
...
```

```
\n
```

Successful response codes

A simple acknowledgement of a command is indicated with a response code of 200:

```
200 ok\n
```

Other successful responses carry parameters and are indicated with response codes in the range of 201 to 299.

Failure response codes

Failure responses to commands are indicated with response codes in the range of 100 to 199:

```
100 syntax error
101 unsupported parameter
102 invalid value
103 unsupported
104 disk full
105 no disk
106 disk error
109 out of range
110 no input
111 remote control disabled
120 connection rejected
150 invalid state
```

Asynchronous response codes

The server may return asynchronous messages at any time. These responses are indicated with response codes in the range of 500 to 599:

```
5xx {Response Text}:↵
{Parameter}: {Value}↵
{Parameter}: {Value}↵
↵
```

Connection Response

On connection, an asynchronous message will be delivered:

```
500 connection info:↵
protocol version: {Version}↵
model: {Model Name}↵
↵
```

Connection rejection

Only one client may connect to the server at a time. If other clients attempt to connect concurrently, they will receive an error and be disconnected:

```
120 connection rejected↵
```

Timecode syntax

Timecodes are expressed as non-drop-frame timecode in the format:

```
HH:MM:SS:FF
```

Handling of deck "remote" state

The "remote" command may be used to enable or disable the remote control of the deck. Any attempt to change the deck state over ethernet while remote access is disabled will generate an error:

```
111 remote control disabled↵
```

To enable or disable remote control:

```
remote: enable: {"true", "false"} ↵
```

The current remote control state may be overridden allowing remote access over ethernet irrespective of the current remote control state:

```
remote: override: {"true", "false"} ↵
```

The override state is only valid for the currently connected ethernet client and only while the connection remains open.

The "remote" command may be used to query the remote control state of the deck by specifying no parameters:

```
remote↵
```

The deck will return the current remote control state:

```
210 remote info:↵
enabled: {"true", "false"}↵
override: {"true", "false"}↵
↵
```

Asynchronous remote control information change notification is disabled by default and may be configured with the "notify" command. When enabled, changes in remote state will generate a "510 remote info:" asynchronous message with the same parameters as the "210 remote info:" message.

Closing connection

The "quit" command instructs the server to cleanly shut down the connection:

```
quit↵
```

Checking connection status

The "ping" command has no function other than to determine if the server is responding:

```
ping↵
```

Getting help

The "help" or "?" commands return human readable help text describing all available commands and parameters:

```
help↵
```

ou

```
?↵
```

The server will respond with a list of all supported commands:

```
201 help:↵
{Help Text}↵
{Help Text}↵
↵
```

Stopping deck operation

The "stop" command instructs the deck to stop the current capture:

```
stop↵
```

Enumerating supported commands and parameters

The "commands" command returns the supported commands:

```
commands↵
```

The command list is returned in a computer readable XML format:

```
212 commands:
<commands>↵
  <command name="..."><parameter name="...">...</command>↵
  <command name="..."><parameter name="...">...</command>↵
  ...
</commands>↵
↵
```

More XML tokens and parameters may be added in later releases.

Controlling asynchronous notifications

The "notify" command may be used to enable or disable asynchronous notifications from the server. To enable or disable transport notifications:

```
notify: transport: {"true", "false"}↵
```

To enable or disable slot notifications:

```
notify: slot: {"true", "false"}↵
```

To enable or disable remote notifications:

```
notify: remote: {"true", "false"}↵
```

To enable or disable configuration notifications:

```
notify: configuration: {"true", "false"}↵
```

To enable or disable dropped frames notifications:

```
notify: dropped frames: {"true", "false"}↵
```

Multiple parameters may be specified. If no parameters are specified, the server returns the current state of all notifications:

```
209 notify:↵  
transport: {"true", "false"}↵  
slot: {"true", "false"}↵  
remote: {"true", "false"}↵  
configuration: {"true", "false"}↵  
↵
```

Retrieving device information

The "device info" command returns information about the connected deck device:

```
device info↵
```

The server will respond with:

```
204 device info:↵  
protocol version: {Version}↵  
model: {Model Name}↵  
unique id: {unique alphanumeric identifier}↵  
↵
```

Example of response from server:

```
204 device info:↵  
protocol version: 1.8↵  
model: Blackmagic Duplicator 4K↵  
unique id: 101112131415↵  
↵
```

Retrieving slot information

The "slot info" command returns information about a slot.

The specified slot will be queried:

```
slot info: slot id: {Slot ID}↵
```

The server will respond with slot specific information:

```
202 slot info:↵  
slot id: {Slot ID}↵  
status: {"empty", "mounting", "error", "mounted"}↵  
volume name: {Volume name}↵  
recording time: {recording time available in seconds}↵  
video format: {disk's default video format}↵  
↵
```

Asynchronous slot information change notification is disabled by default and may be configured with the “notify” command. When enabled, changes in slot state will generate a “502 slot info:” asynchronous message with the same parameters as the “202 slot info:” message.

Retrieving transport information

The “transport info” command returns the state of the transport:

```
transport info ↵
```

The server responds with transport specific information:

```
208 transport info:↵
status: {"stopped","record"}↵
display timecode: {timecode}↵
timecode: {timecode}↵
```

The “timecode” value is the timecode within the current timeline for playback or the clip for record. The “display timecode” is the timecode displayed on the front of the deck. The two timecodes will differ in some deck modes.

Asynchronous transport information change notification is disabled by default and may be configured with the “notify” command. When enabled, changes in transport state will generate a “508 transport info:” asynchronous message with the same parameters as the “208 transport info:” message.

Video Formats

The following video formats are currently supported on Blackmagic Duplicator 4K:

SD

525i59.94 NTSC

625i50 PAL

HD

720p50	1080p30
720p59.94	1080i50
720p60	1080p50
1080p23.98	1080i59.94
1080p24	1080p59.94
1080p25	1080i60
1080p29.97	1080p60

Ultra HD

2160p23.98	2160p30
2160p24	2160p50
2160p25	2160p59.94
2160p29.97	2160p60

Duplicator 4K supports progressive segmented frame modes, and automatically detects level A and level B 3G-SDI formats for 1080p50, 1080p59.94 and 1080p60.

File Formats

Duplicator 4K supports the following file formats:

- H.264Low
- H.264Medium
- H.264High
- H.265Low
- H.265Medium
- H.265High

Querying and updating configuration information

The "configuration" command may be used to query the current configuration of the deck:

```
configuration↵
```

The server returns the configuration of the deck:

```
211 configuration:↵  
video input: {"SDI", "optical"}↵  
↵
```

One or more configuration parameters may be specified to change the configuration of the deck.

To change the current video input:

```
configuration: video input: {"SDI", "optical"}↵
```

Configuring the watchdog

The "watchdog" command instructs the deck to monitor the connected client and terminate the connection if the client is inactive for at least a specified period of time.

To configure the watchdog:

```
watchdog: period: {period in seconds}↵
```

To avoid disconnection, the client must send a command to the server at least every {period} seconds. Note that if the period is set to 0 or less than 0, connection monitoring will be disabled.

Configuring the record mode

Use the 'record mode' command to select the deck recording mode:

```
configuration: record mode: {"Duplicate", "SingleDisk", "DiskOverwrite"}↵
```

Configuring the file format

The 'file format' command instructs the deck to switch to a specific file format for codec and bit rate:

```
configuration: file format: {"H.264High", "H.264Medium", "H.264Low",  
"H.265High", "H.265Medium", "H.265Low"}↵
```

Ajuda

Obter Ajuda

A maneira mais rápida de obter ajuda é visitando as páginas de suporte online da Blackmagic Design e consultando os materiais de suporte mais recentes disponíveis para o Blackmagic Duplicator 4K.

Central de Suporte Técnico Online da Blackmagic Design

O manual, o programa e as notas de suporte mais recentes podem ser encontrados na Central de Suporte Técnico da Blackmagic Design em www.blackmagicdesign.com/br/support.

Fórum Blackmagic Design

O fórum da Blackmagic Design no nosso site é um recurso útil que você pode acessar para obter mais informações e ideias criativas. Também pode ser uma maneira mais rápida de obter ajuda, pois já podem existir respostas de outros usuários experientes e da equipe da Blackmagic Design, o que o ajudará a seguir em frente. Você pode visitar o fórum em <https://forum.blackmagicdesign.com>.

Como Entrar em Contato com o Suporte Técnico Blackmagic Design

Caso não encontre a ajuda que precisa no nosso material de suporte ou no fórum, por favor use o botão “Envie-nos um email” na página de suporte para nos encaminhar uma solicitação de suporte. Como alternativa, clique no botão “Encontre sua equipe de suporte local” na página de suporte e ligue para a sua central de assistência técnica Blackmagic Design mais próxima.

Verificar a Versão de Software Atualmente Instalada

Para verificar qual versão do software utilitário Blackmagic Duplicator está instalada no seu computador, abra a janela “About” do utilitário Blackmagic Duplicator.

- No macOS, abra o Blackmagic Camera Utility na pasta de aplicativos. Selecione “About” no utilitário Blackmagic Duplicator no menu de aplicativos para revelar o número da versão.
- No Windows 8.1, abra o utilitário Blackmagic Duplicator a partir do ladrilho Blackmagic Duplicator Utility na página Iniciar. Clique no menu “Ajuda” e selecione “Sobre Blackmagic Duplicator Utility” para revelar o número da versão.
- No Windows 10, abra o Blackmagic Duplicator Utility a partir do menu “Iniciar”. Clique no menu “Ajuda” e selecione “Sobre Blackmagic Duplicator Utility” para revelar o número da versão.

Como Obter as Atualizações de Software Mais Recentes

Depois que verificar a versão do software Blackmagic Duplicator Utility instalada no seu computador, por favor, visite a Central de Suporte Técnico da Blackmagic Design em www.blackmagicdesign.com/br/support para conferir as últimas atualizações. Embora seja uma boa ideia executar as atualizações mais recentes, é recomendável evitar atualizar qualquer software caso esteja no meio de um projeto importante.

Informações regulatórias

Descarte de resíduos de equipamentos elétricos e eletrônicos na União Europeia.



O símbolo no produto indica que este equipamento não pode ser descartado com outros materiais residuais. Para descartar o equipamento usado, ele deve ser entregue em um ponto de coleta designado para reciclagem. A coleta e a reciclagem seletivas de seu equipamento usado no momento do descarte ajudarão a conservar os recursos naturais e a garantir que ele seja reciclado de modo a proteger a saúde humana e o meio ambiente. Para mais informações sobre onde você pode eliminar os resíduos do seu equipamento para reciclagem, por favor entre em contato com a agência de reciclagem local da sua cidade ou o revendedor do produto adquirido.



Este equipamento foi testado e respeita os limites para um dispositivo digital Classe A, conforme a Parte 15 das normas da FCC. Esses limites foram criados para fornecer proteção razoável contra interferências nocivas quando o equipamento é operado em um ambiente comercial. Este equipamento gera, usa e pode irradiar energia de radiofrequência e, se não for instalado ou usado de acordo com as instruções, poderá causar interferências nocivas nas comunicações via rádio. A operação deste produto em uma área residencial pode causar interferência nociva, nesse caso o usuário será solicitado a corrigir a interferência às suas próprias custas.

A operação está sujeita às duas condições a seguir:

- 1 Este dispositivo não poderá causar interferência nociva.
- 2 Este dispositivo deve aceitar qualquer interferência recebida, incluindo interferência que possa causar uma operação indesejada.

Norma Canadense ISED

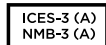

Este dispositivo está em conformidade com os padrões canadenses para equipamentos digitais de Classe A.

Qualquer modificação ou uso indevido do dispositivo poderá invalidar a conformidade com tais normas.

Este equipamento foi testado para conformidade com a sua finalidade original em um ambiente comercial.

Se o equipamento for usado em ambiente doméstico, ele poderá causar interferência radioelétrica.

Informações de segurança

Este equipamento deve ser conectado a uma tomada com conexão de aterramento de proteção.

Para reduzir o risco de choque elétrico, não exponha este equipamento a gotas ou respingos.

Este equipamento é adequado para uso em locais tropicais com uma temperatura ambiente de até 40°C.

Certifique-se de que seja fornecida ventilação adequada em torno do produto e que não seja colocado em local com ventilação restrita. Ao montar o produto em rack, certifique-se de que a ventilação não ficará reduzida em função do equipamento adjacente.

Não há peças que possam ser reparadas pelo operador no interior do produto. Consulte o serviço de assistência técnica local da Blackmagic Design.

Este produto tem os recursos de conexão para módulos transceptores de fibra ótica com fator de forma SFP. Use apenas módulos SFP ópticos de Laser de classe 1.

Módulos SFP recomendados pela Blackmagic Design:

- **3G-SDI:** PL-4F20-311C
- **6G-SDI:** PL-8F10-311C
- **12G-SDI:** PL-TG10-311C



Use apenas em altitudes inferiores a 2000 m acima do nível do mar.

Declaração do Estado da Califórnia

Este produto pode expor o usuário a substâncias químicas, incluindo cromo hexavalente que, de acordo com o estado da Califórnia, causam câncer, defeitos congênitos ou outros danos reprodutivos.

Para mais informações, visite www.P65Warnings.ca.gov.

Aviso para Pessoal de Assistência Autorizado



Cuidado – Interruptor Bipolar/ Aterramento Neutro

A fonte de alimentação neste equipamento possui um fusível tanto nos condutores de linha quanto neutro e é adequada para conexão com o sistema de distribuição de alimentação IT na Noruega.

Garantia

12 Meses de Garantia Limitada

A Blackmagic Design garante que este produto estará isento de quaisquer defeitos de materiais e fabricação por um período de 12 meses a partir da data de compra. Se um produto revelar-se defeituoso durante este período de garantia, a Blackmagic Design, a seu critério, consertará o produto defeituoso sem cobrança pelos componentes e mão-de-obra, ou fornecerá a substituição em troca pelo produto defeituoso.

Para obter o serviço sob esta garantia você, o Consumidor, deve notificar a Blackmagic Design do defeito antes da expiração do período de garantia e tomar as providências necessárias para o desempenho do serviço. O Consumidor é responsável pelo empacotamento e envio do produto defeituoso para um centro de assistência designado pela Blackmagic Design com os custos de envio pré-pagos. O Consumidor é responsável pelo pagamento de todos os custos de envio, seguro, taxas, impostos e quaisquer outros custos para os produtos retornados para nós por qualquer razão.

Esta garantia não se aplica a defeitos, falhas ou danos causados por uso inadequado ou manutenção e cuidado inadequado ou impróprio. A Blackmagic Design não é obrigada a fornecer serviços sob esta garantia: a) para consertar danos causados por tentativas de instalar, consertar ou fornecer assistência técnica ao produto por pessoas que não sejam representantes da Blackmagic Design, b) para consertar danos causados por uso ou conexão imprópria a equipamentos não compatíveis, c) para consertar danos ou falhas causadas pelo uso de componentes ou materiais que não são da Blackmagic Design, d) para fornecer assistência técnica de um produto que foi modificado ou integrado a outros produtos quando o efeito de tal modificação ou integração aumenta o tempo ou a dificuldade da assistência técnica do serviço. ESTA GARANTIA É FORNECIDA PELA BLACKMAGIC DESIGN NO LUGAR DE QUAISQUER OUTRAS GARANTIAS, EXPLÍCITAS OU IMPLÍCITAS. A BLACKMAGIC DESIGN E SEUS FORNECEDORES NEGAM QUAISQUER GARANTIAS IMPLÍCITAS DE COMERCIALIZAÇÃO OU ADEQUAÇÃO A UMA FINALIDADE ESPECÍFICA. A RESPONSABILIDADE DA BLACKMAGIC DESIGN DE CONSERTAR OU SUBSTITUIR PRODUTOS DEFEITUOSOS É A ÚNICA E EXCLUSIVA MEDIDA FORNECIDA AO CONSUMIDOR PARA QUAISQUER DANOS INDIRETOS, ESPECIAIS OU ACIDENTAIS INDEPENDENTEMENTE DA BLACKMAGIC DESIGN OU DO FORNECEDOR TIVER INFORMAÇÃO PRÉVIA SOBRE A POSSIBILIDADE DE TAIS DANOS. A BLACKMAGIC DESIGN NÃO É RESPONSÁVEL POR QUAISQUER USOS ILEGAIS DO EQUIPAMENTO PELO CONSUMIDOR. A BLACKMAGIC NÃO É RESPONSÁVEL POR QUAISQUER DANOS CAUSADOS PELO USO DESTE PRODUTO. O USUÁRIO DEVE OPERAR ESTE PRODUTO POR CONTA E RISCO PRÓPRIOS.

© Direitos autorais 2019 Blackmagic Design. Todos os direitos reservados. 'Blackmagic Design', 'DeckLink', 'HDLink', 'Workgroup Videohub', 'Multibrigde Pro', 'Multibrigde Extreme', 'Intensity' e 'Leading the creative video revolution' são marcas comerciais registradas nos Estados Unidos e em outros países. Todos os outros nomes de empresas e produtos podem ser marcas comerciais de suas respectivas empresas com as quais elas são associadas. Thunderbolt e o logotipo Thunderbolt são marcas registradas da Intel Corporation nos Estados Unidos e/ou em outros países.

Blackmagicdesign



Kurulum ve Kullanım Kılavuzu

Blackmagic Duplicator 4K

Şubat 2019

Türkçe



Hoş Geldiniz

Blackmagic Duplicator 4K ürünümüzü satın aldığınız için teşekkür ederiz.

Blackmagic Duplicator 4K cihazını tasarlamış olmaktan son derece heyecanlıyız ve müşterilerinize doğrudan yüksek kalite Ultra HD içerik vermenizi sağlayacak, mükemmel bir çözüm olduğunu düşünüyoruz. Bu mümkündür çünkü, çoğaltıcı (duplicator) cihazı, yaygın olarak kullanılan H.264 ya da en son H.265 sıkıştırma standartlarında, 2160p60'a kadar tüm SD, HD ve Ultra HD formatlarında 25 ayrı SD karta kaydeder. Böylelikle, muhteşem kaliteye ve yüksek kare hızlarına ulaşmanın yanı sıra, data hızlarının yeterince düşük olması nedeniyle, ucuz kartları kullanabilir ve uzun bir kayıt süresi elde edebilirsiniz.

Blackmagic Duplicator 4K'nın kurulumu ve kullanımı çok kolaydır. Ön panelindeki dahili LCD ekran ve kontrol paneli sayesinde ayarları değiştirebilir ve butonlar ile üniteyi kontrol edebilirsiniz. Ayrıca, çoğaltıcı cihazını Ethernet ile ya da bir RS-422 kontrolör ile uzaktan kontrol edebilirsiniz. Dilerseniz kendi kumanda cihazınızı geliştirip, üniteyi Blackmagic HyperDeck Ethernet Protokolü ile kontrol edebilirsiniz.

Dahili gerçek zamanlı H.265 video kodlayıcı, Ultra HD 2160p60'a kadar video formatlarında, ucuz SD kartlarına yüksek kalitede video kaydeder. Böylece, piyasadaki en hızlı kartları kullanmak zorunda kalmadan, harika Ultra HD video kaydedebilirsiniz. En son Blackmagic Duplicator 4K 1.2 yazılımına ilave ettiğimiz H.264 sıkıştırma sayesinde, daha iyi bir uyumluluk için H.264 dosyalarını da kaydedebilirsiniz!

Blackmagic Duplicator 4K'nın, 1 rack ünitesi boyunda olması sayesinde, portatif bir raf sisteminde birden fazla üniteyi birbirine zincirleme bağlayabilir ve dış mekanlara rahatlıkla yanınızda götürüp, yüzlerce SD karta, aynı anda kayıt yapabilirsiniz.

Bu kurulum ve kullanım kılavuzu, Blackmagic Duplicator 4K'yı kullanmaya başlamanız için ihtiyacınız olan tüm bilgileri içerir.

Bu kullanım kılavuzunun en güncel sürümü ve Blackmagic Duplicator 4K yazılımı güncellemeleri için, lütfen www.blackmagicdesign.com/tr adresindeki internet sitemizden, destek bilgilerini içeren sayfamıza bakın. Yazılımınızı güncel tutarak, en son özelliklerden yararlandığınızdan emin olabilirsiniz. Yeni yazılımlar piyasaya sürüldüğünde size duyurabilmemiz için, bilgisayarınıza yazılımı indirirken, bilgilerinizi sitemize kaydetmenizi rica ediyoruz. Sürekli yeni özellikler ve geliştirmeler için çaba içinde olduğumuzdan, yorumlarınızı almaktan mutluluk duyarız.

Grant Petty
Blackmagic Design CEO

İçindekiler

Blackmagic Duplicator 4K

Başlarken	376
Güç Kaynağının Takılması	376
Video ve Ses Kaynaklarının Bağlanması	376
Birden Fazla Cihazın Birbirine Bağlanması	377
SD Kartların Yerleştirilmesi ve Formatlanması	378
Kaydetme	379
Kayıt Modunun Ayarlanması	379
Kodeğin Belirlenmesi	380
Bit Oranının Ayarlanması	381
Kliplerin Kaydedilmesi	382
LED Durum Göstergeleri	382
Kayıt Ekleme	383
Blackmagic Duplicator 4K'nızın Kilitlenmesi	384
Birden Fazla Çoğaltıcının Birbirine Bağlanması	384
LCD Menü Ayarları	386
Kaydet	386
Ayarlar	391
Hakkında	392
Blackmagic Duplicator Yardımcı Yazılımı	392
Blackmagic Duplicator 4K'nızın Güncellenmesi	392
File Name Prefix (Dosya Adı Öneki)	392
İsteğe Bağlı Optik Fiber SDI Modülünün Takılması	393
RS-422 Kontrol	394
RS-422 Kontrol Nedir?	394
Harici bir RS-422 Kontrolörünün Kullanımı	394
RS-422 Yazılım Geliştirici Bilgileri	396
Ethernet ile Uzaktan Kontrol	396
Bir Arduino üzerinden Kontrol Etme için bir Örnek	397
Blackmagic HyperDeck Ethernet Protokolü	399
Protocol Komutları	399
Protocol Details	400
Configuring the watchdog	405
Configuring the record mode	405
Configuring the file format	405
Yardım	406
Düzenleyici Uyarıları	407
Güvenlik Bilgileri	408
Garanti	409

Başlarken

Blackmagic Duplicator 4K'nızı kullanmaya başlamak çok kolay!

Tüm yapmanız gereken; cihazı bir güç kaynağına takmak, SDI video kaynağını takmak ve 25 adede kadar SD kartı yerleştirmektir. Bundan daha fazla sayıda SD karta kaydetmeyi istediğinizde, birkaç Blackmagic Duplicator 4K'yı birbirine kolaylıkla bağlayabilirsiniz çünkü, sinyal yönündeki her üniteye bağlanması için, dahili video ve kontrol bağlantıları vardır. Birden fazla SD karta aynı anda kaydetmeye hemen başlayabilmeniz için, kılavuzun bu kısmında, Blackmagic Duplicator 4K'nızı tam olarak nasıl kurabileceğinizle ilgili bilgiler sunulmuştur.

Güç Kaynağının Takılması

Blackmagic Duplicator 4K cihazınızı çalıştırmak için yapmanız gereken tek şey, standart bir IEC elektrik kablosunu, arka paneldeki 110-240V AC güç girişine takmaktır.

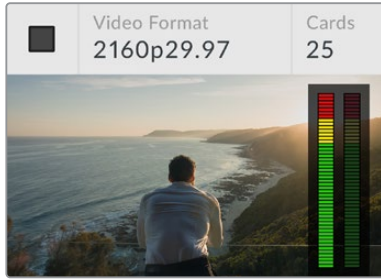

Blackmagic Duplicator 4K'yı çalıştırdığınızda, ana ekranı dahili LCD ekranda göreceksiniz.

Ana Ekran

Kaynak video görüntüsünün yanı sıra, ana ekran; kaynak video formatı, takılı SD kart sayısı, kayıt yaptığınızı ve kaydın durduğunu gösteren bir durum göstergesi ve kaynak videodaki ses seviyelerini denetleyebilmemiz için ses göstergeleri gibi bilgileri görüntüler.

Video ve Ses Kaynaklarının Bağlanması

Kaynak videonuzu, arka paneldeki 12G-SDI girişine takın. Blackmagic Duplicator 4K'nız otomatik olarak giriş formatını tespit edecek ve LCD ana ekranında görüntüleyecektir.

SDI giriş ve çıkış BNC konektörleri, 12G-SDI'ya kadar olan video sinyallerini desteklediğinden, tek bir BNC kabloyla 2160p60'a kadar SD, HD veya Ultra HD video takabilirsiniz. Bu şekilde, loop (düz geçiş) çıkışınız daima kaynak video formatınız ile eşleşecektir ve böylelikle, diğer SDI video ekipmanlarına veya birden fazla Blackmagic Duplicator 4K'yı birbirine paralel bağladığınızda, aynı sinyali gönderebilirsiniz. Blackmagic Duplicator 4K ayrıca, 'progressive segmented frame (PsF)' olarak bilinen parçalara ayrılmış tek geçişli kare modlarını destekler ve 1080p50, 1080p59.94 ve 1080p60 için A seviye ve B seviye 3G-SDI formatlarını otomatik olarak tespit eder.

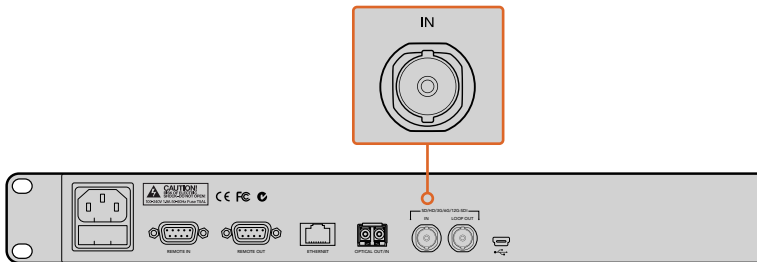

Kaynak videonuzu SDI giriş bağlantısına takın.
Ses, SDI video sinyalinde gömülüdür.

Blackmagic Duplicator 4K, 2 kanal gömülü SDI sesi destekler. Yani, SDI video girişi üzerinden ses zaten bağlı olduğu için, sesi bağlamanıza gerek yoktur.

BİLGİ Kaynak videonuzun ses seviyelerini, ana LCD ekranında denetleyebilirsiniz.

Birden Fazla Cihazın Birbirine Bağlanması

Daha çok sayıda SD karta kaydedebilmek için, birden fazla Blackmagic Duplicator 4K'yı birbirine bağlayabilirsiniz. Örneğin, 100 adet kartı çoğaltmayı istediğinizde, sadece 4 üniteyi birbirine bağlamanız yeterlidir.

- 1 Birinci Blackmagic Duplicator 4K'daki RS-422 'uzaktan kontrol' çıkışını, ikinci ünitedeki 'uzaktan kontrol' girişine takın. Zincirdeki her ünite için, bu işlemi tekrar edin.
- 2 Benzer bir şekilde, ilk ünitenin loop SDI çıkışını, ikinci ünitenin SDI girişine takın ve diğer üniteler için aynı işlemi tekrar edin.
- 3 Her ünitenin kontrol panelinde, 'REM' olarak işaretli bir buton vardır. Bu, 'uzaktan kontrol' butonudur ve üniteler arası uzaktan kontrol için, etkinleştirilmesi gerekir. İkinci üniteden başlayarak, sırasıyla tüm Blackmagic Duplicator 4K ünitelerinin üzerindeki 'remote' (uzaktan kontrol) butonuna basın.

NOT Zincirdeki diğer ünitelerin hepsini kontrol edeceği için, ilk Blackmagic Duplicator 4K'nın üzerindeki 'uzaktan kontrol' butonunun etkisiz halde olduğundan emin olun. Uzaktan kontrol butonu etkisiz haldeki ilk ünite, ana ünite ve ön panelindeki basılı olan herhangi bir butonun çıkışı, 'uzaktan kontrol' çıkışından yapılacaktır. Bu, sinyal akış yönündeki 'uzaktan kontrol' butonları basılı olan üniteleri kontrol eder. Uzaktan kontrol protokolü, endüstri standardında deck kontrol formatı olduğundan, RS-422 deck kontrolü olan herhangi bir televizyon cihazı, ana ünite olarak kullanılabilir.

Artık, zincirde bulunan tüm Blackmagic Duplicator 4K üniteleri, ilk ünitenin komutlarını takip etmeye hazırdır.

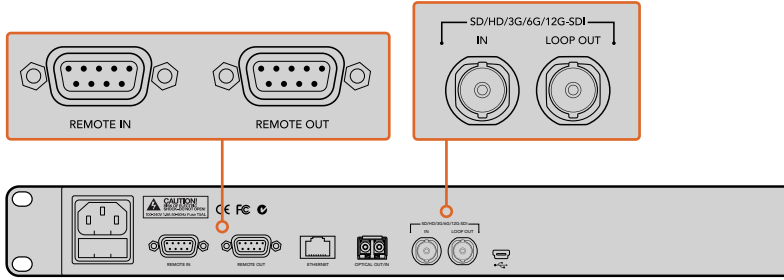

Uzaktan kontrol (remote) ve 'loop' konektörleri, birden fazla Blackmagic Duplicator 4K'nın birbirine bağlanmasında kullanıldı. En son üniteye düz geçiş (loop) konektörü; Blackmagic SmartView monitör veya HyperDeck disk kaydedici gibi, diğer SDI ekipmanlara kaynak videoyu bağlamak için de kullanılabilir.

Birden fazla üniteyi birbirine bağlama hakkında daha fazla bilgi için, 'Birden Fazla Duplicator Ünitesinin Birbirine Bağlanması' başlıklı bölüme bakınız.

SD Kartların Yerleştirilmesi ve Formatlanması

Blackmagic Duplicator 4K, yaygın class 10 SD kartları kullanır. Böylece, piyasadaki en hızlı kartları almak zorunda kalmazsınız. SD kartlar, kamera ekipmanı satan tüm mağazalardan satın alınabilir ve hatta bazı süpermarketlerde bile class 10 SD kartları bulabilirsiniz.

BİLGİ Tüm SD kartların etiketlerinde, küçük bir daire içinde basılı, 1'den 10'a kadar bir rakam göreceksiniz. Bu rakam, kartın hız değerini temsil eder ve 10, en yüksek hızı temsil eder. Daire içinde 10 rakamının basılı olduğu her kart, class 10 SD karttır ve Ultra HD'ye kadar en yüksek bit oranı ayarında, video kaydetmek için ihtiyacınız olan kart türüdür.

Bir SD kartı takmak için:

- 1 Altın rengindeki konektörler, kontrol panel LCD ekranına bakacak şekilde kartı tutun ve Blackmagic Duplicator 4K'nın SD kart yuvalarından biri ile aynı hizaya getirin.
- 2 Yuvaya sıkıca oturana kadar, kartı yuvanın içine yavaşça itin. Blackmagic Duplicator 4K'nız kartı hemen doğrular ve kart kayda hazır olduğunda, kart yuvasının üstündeki LED durum göstergesi yeşil renge dönüşür.

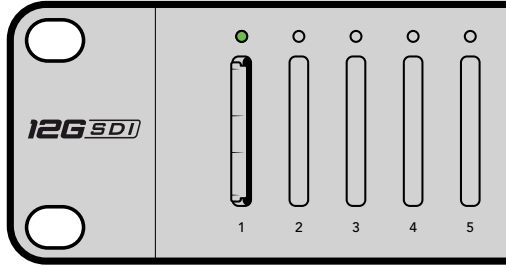
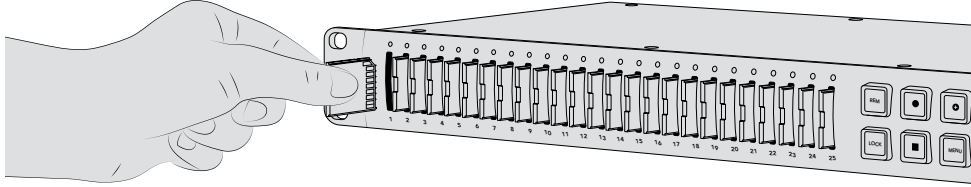

SD kartı, altın rengindeki konektörleri LCD ekrana bakarken hizaya getirin ve yuvaya sıkıca oturana kadar, kartı hafifçe yuvanın içine itin. Kartınız kayda hazır olduğunda, LED durum göstergesi yeşil renge dönüşür.

Kartı çıkarmak için, kenarından tutun ve yuvadan çıkartın.

BİLGİ Bir kartı yerleştirirken, kartın yazma korumalı olmadığından emin olun. Yazma koruması, kartın sol tarafındaki küçük plastik düğmenin, konektörlere en yakın olan konuma hareket ettirilmesiyle etkisiz hale getirilir. Kayıt bittikten sonra, düğmeyi tekrar alttaki eski konumuna kaydırarak, kartı yazma korumalı hale getirebilirsiniz.

SD Kartların Formatlanması

Kaydetmeye başlamadan önce, SD kartlarınızı exFAT formatına formatlamanız gerekecektir. Bu format hem macOS hem de Windows bilgisayarları ile uyumludur. Blackmagic Duplicator 4K'nın 'format' özelliği ile ortamınızın formatlanması kolaydır ve tek bir üniteye, aynı anda 25 adede kadar SD kartın formatlanması için kullanılabilir.

SD kartlarınızı Blackmagic Duplicator 4K'da formatlamak için:

- 1 Kontrol panelinin üzerindeki 'Menu' butonuna basın.
- 2 LCD ekranın her iki yanında bulunan ışıklı ekran butonlarını kullanarak 'record' (kayıt) ibaresine basın.
- 3 'Format cards' (kartları formatla) ayarını seçmek için, sol ok ekran butonuna basın, sonra da LCD ekran menüsünün sağ alt köşesindeki 'format' butonuna basın.
- 4 Formatı doğrulamanız için bir uyarı mesajı belirecektir. Formatlama işlemi onaylamak için ekrandaki 'format' butonuna basın ya da durdurmak için, 'cancel' (iptal) butonuna basın.
- 5 Bir gelişme çubuğu, formatlamanın ilerlemesini gösterir. Formatlama işlemi tamamlandıktan sonra, 'OK' ibaresini tıklayın.
- 6 Ana ekrana geri dönmek için kontrol paneldeki menü butonuna basın.

Kullanıma başlamanız için yapmanız gerekenler bu kadardır. Video ve sesiniz bağlandığına ve SD kartlarınız formatlandığına göre, artık kayıt yapmaya başlayabilirsiniz!

BİLGİ Farklı tür ve boyuttaki SD kartların formatlanması, farklı hızlarda olabilir. Bu bakımdan, bazı kartlar formatlama işlemi diğer kartlardan daha hızlı tamamlar.

Kaydetme

Kontrol panelindeki kayıt düğmesine basarak kayıt işlemi anında başlatabilirsiniz. Lakin, ilk olarak kayıt modunu, kodeği ve bit oranını ayarlamanız tavsiye edilir; çünkü bunlar, kullanılan kayıt türünün yanında, kaydınızın süresi ile kalitesini de belirleyecektir.

Kayıt Modunun Ayarlanması

Blackmagic Duplicator 4K'da aşağıdaki modlar bulunmaktadır:

- **Çoğalt:** SD kartları hepsine aynı anda yaz.
- **Tek Disk:** sırayla SD kartlara birer birer yaz ve son kart dolduğunda, kayıt işlemi durdur.
- **Tek Disk Overwrite (Üzerine Yazma):** sırayla SD kartlara birer birer yaz ve sürekli bir döngü halinde üzerlerine yaz.

Çoğaltma Modu

Çoğaltma modunda, Blackmagic Duplicator 4K, tüm SD kartlara aynı anda aynı videoyu kaydeder.

Tek Disk Modu

Blackmagic Duplicator 4K; televizyon yayınlarından, güvenlik kameralarına kadar çok sayıda uygulaması olan, ideal bir logging (günlüklemeli) kaydedicidir. Yuvalardaki SD kartlara birer birer yazar ve SD kart dolduğunda, sıradaki yuvada olan başka bir SD karta yazmaya devam eder. Blackmagic Duplicator 4K tek disk modunda iken, SD kartların hepsi dolunca kaydı durdurur. 25 adet kayıt yuvasının olmasıyla, bir hafta süresince kolaylıkla kayıt yapabilirsiniz. Sürekli ve kesintisiz kayıt için, dolu kartları boş kartlarla dilediğiniz zaman değiştirebilirsiniz.

Birden fazla duplicator (çoğaltıcı) cihazını birbirine bağlarsanız daha da uzun süre boyunca bile kaydedebilirsiniz. Ana üniteadaki kartların hepsi dolduğunda, kayıt, bağımlı ilk üniteye geçer ve zincirde bulunan bağlı ünitelere kayıt devam eder. Son üniteadaki en son kart dolduğunda, kayıt işlemi durur.

Tek Disk Üzerine Yazma (Single Disk Overwrite) Modu

Tek disk üzerine yazma modu; iki ya da daha fazla SD kartı olan tek bir Blackmagic Duplicator 4K'nın, en son kart dolduğunda ilk karta dönmesini mümkün kılarak kaydın aralıksız devam etmesini sağlar. Bir defada sadece bir yuvadaki SD karta yazar. Bir SD kart dolunca, bir sonraki yuvada bulunan kartı formatlayıp yazmaya başlar.

Bu mod, tek disk moduna benzer, ama en son kart dolduğunda, cihaz durmak yerine, bir sonraki kartı formatlar ve döngü şeklinde yazmaya devam eder. Tek disk üzerine yazma modunda Blackmagic Duplicator 4K'nız, siz durdur düğmesine basana kadar, kaydetmeye süresiz devam eder.

BİLGİ Tek disk modunda ya da tek disk üzerine yazma modunda kaydediyorsanız yeni boş SD kartları dilediğiniz zaman takabilirsiniz. Duplicator 4K; 25 kart yuvasının herhangi birinde, boş yeri olan bir kart olduğu sürece, kaydetmeye devam edecektir.

Bir kayıt modunu belirlemek için:

- 1 Blackmagic Duplicator 4K'yı çalıştırın.
- 2 LCD menüyü açmak için, ön kontrol panelindeki 'menu' butonuna basın. Ekranın yanında bulunan ekran butonları, menüdeki seçenekleri görebilmeniz için yanarlar. 'Record' (kayıt) ekran butonuna basın.
Kayıt menüsünde, ekranın alt kısmında, geçerli seçenek sayısını gösteren noktalar vardır. Menüde bir önceki seviyeye geçmek istediğiniz zaman, 'back' (geri) butonuna basın. Seçenekler arasında gezinmek için '<' ve '>' butonlarını kullanın.
- 3 'Mode' seçeneğine gidin ve 'change' (değiştir) ibaresini tıklayın.
- 4 Şu an gösterilen modu kullanmak için, 'select' butonuna basın. LCD menüsü, yaptığınız seçimi gösterir.
- 5 Kayıt menüsüne geri dönmek için 'back' (geri) butonuna basın. Seçtiğiniz seçenek şimdi görüntülenmiştir.

Birden fazla çoğaltıcı cihazının birbirine bağlanması konusunda daha fazla bilgi için, 'birbirine bağlama' ve 'birden fazla çoğaltıcının birbirine bağlanması' bölümlerine bakınız.

BİLGİ Önemli bir etkinliği tek disk modunda veya tek disk üzerine yazma modunda kaydediyorsanız ve mevcut kartın dolmasını beklemeden bu SD kartı çıkarmayı istiyorsanız, kaydın bir sonraki SD kartta devam etmesi için, 'record' butonunu üç saniyelik bir süre basılı tutun. Çoğaltma modunda kaydederken, 'append record' (kayıt ekleme) butonuna basarak aynı işlemi gerçekleştirebilirsiniz. Daha fazla bilgi için, kılavuzun 'Kayıt ekleme' bölümüne bakın.

Kodeğin Belirlenmesi

Blackmagic Duplicator 4K'nız; H.264 veya H.265 sıkıştırma kodeklerini kullanarak dosya kaydedebilir. H.264 sıkıştırma, varsayılan kodektir.

Kodeđi deđiřtirmek iin:

- 1 'Menu' butonuna basın
- 2 Kayıt ayarlarını amak iin 'record' ekran butonuna basın.
- 3 Ekranüstü ok butonları ile 'codec' ayarına gidin ve 'change' (deđiřtir) ibaresine basın.
- 4 Tercih ettiđiniz kodeđi semek iin ekran üstü ok butonlarını kullanın ve sonra deđiřikliđi onaylamak iin 'set' ibaresine basın veya deđiřikliđi onaylayıp ana LCD ekrana geri dönmek iin, kontrol panelindeki 'menu' butonuna basın.

NOT Kodeklerin deđiřtirmesi iin, Blackmagic Duplicator 4K cihazınızdaki yazılımın 1.1 veya üzeri bir sürüme güncellenmiř olması gerekmektedir. Yazılımın güncellenmesi konusunda daha fazla bilgi iin, bu kılavuzun 'Blackmagic Duplicator Yardımcı Yazılımı' bölümüne bakın.

Dođru kodeđin seilmesi

En üst düzeyde uyumluluk iin, H.264 kodeđinin kullanılmasını öneriyoruz. H.264 kodeđini Blackmagic Duplicator 4K iin varsayılan codec yapmamızın sebebi budur.

H.265; daha küçük dosyalarda yüksek kalite Ultra HD video iin harika bir kodektir; fakat henüz çok yeni olduđundan, bilgisayar ve oynatıcı cihazlar ile uyumluluđu yeterli olmayabilir.

Her iki kodeđin de kendisine göre avantajları vardır. Belli bir görüntü kalitesi iin bit oranları ve dosya boyutları daha düşük olacađından, H.265 kodeđini kullanma, daha ucuz SD depolama kartlarını kullanmanıza imkan tanır. Projeniz iin uyumluluk çok önemli ise, sizin iin H.264 daha uygun bir tercihtir.

Bit Oranının Ayarlanması

Blackmagic Duplicator 4K'nızda; düşük, orta ve yüksek olarak üç farklı bit oranı bulunur. Bunlar; videonun her saniyesi iin, dahili video kodlayıcı tarafından yazılacak veri miktarını belirlemenize yarar. Yüksek kalite bir kayıt ve yönetilebilir dosya büyüklüğü iin varsayılan bit oranı ayarı ortadır. Buna karřın, bu ayarı LCD menüsünde kolaylıkla deđiřtirebilirsiniz.

Bit oranı ayarını deđiřtirmek iin:

- 1 'Menu' butonuna basın.
- 2 Kayıt ayarlarını amak iin 'record' ekran butonuna basın.
- 3 Ekranüstü ok butonları ile 'rate' ayarına gidin ve 'change' (deđiřtir) ibaresine basın.
- 4 Tercih ettiđiniz bit oranını semek iin ekran üstü ok butonlarını kullanın ve sonra deđiřikliđi onaylamak iin 'set' ibaresine basın veya deđiřikliđi onaylayıp ana LCD ekrana geri dönmek iin, kontrol panelindeki 'menu' butonuna basın.

NOT Bit oranları ne kadar yüksek olursa kayıtlar da o kadar yüksek kalitede sonuçlanır fakat, bir kartı daha hızlı doldurur ya da daha büyük ve daha pahalı bir kartı gerektirir. Ancak, veri oranının azaltılması bir karta yapabileceđiniz kaydın süresini artıracaktır, ama görüntü kalitesinin arzu ettiđinizden daha düşük olmasına sebep olabilir.

İhtiya duyduđunuz görüntü kalitesini, mümkün olabilecek en küçük dosya boyutunda elde etmek iin, farklı bit oran ayarları ile deneme kayıtlar yapmanızda fayda vardır.

Kliplerin Kaydedilmesi

Kayı başlatmak için, kontrol panelindeki kayıt düğmesine basın. Kayıt esnasında, her kart yuvasının LED durum göstergesi, kırmızı renkte yanar. Kayıt işlemi durduğunda, LED gösterge yeşil renkte yanar ve kaydın başarıyla tamamlandığını ve kartın bir başka klipi kaydetmeye hazır olduğunu, bu şekilde belirtir. Kayıtlarınızı; SD kart yuvası ya da okuyucusu aracılığıyla, bir bilgisayarda kolaylıkla kontrol edebilirsiniz ya da SD kartları ve exFAT dosya sistemini destekleyen bir HDMI televizyonda da bunu yapabilirsiniz.

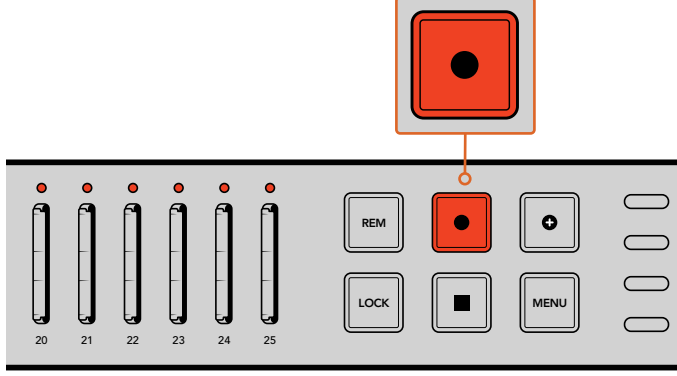

Kayı başlatmak için, 'record' düğmesine basın. Her bir kart yuvasının üstündeki LED durum göstergesi, SD kartların kaydettiğini göstermek için kırmızı olarak yanar.

LED Durum Göstergeleri

Her SD kart yuvasının üstündeki LED durum göstergesi, kart yuvasının durumunu size bildirmek için, farklı renklerde yanar. Örneğin; bir SD kartı takarken, yuvasının LED göstergesi kartın tanındığını ve kayda hazır olduğunu göstermek için, yeşil renkte yanar.

Her bir LED rengi, LED hareketi ve durumu için açıklamalar aşağıdadır.



Sürekli yeşil

Kayda hazır. Kartınızın kayda hazır olduğunu göstermek için, LED yeşil renkte yanar.



Sürekli kırmızı

Kaydediyor. Bir klip kaydedilirken, LED sürekli kırmızı renkte yanar.



Yanıp sönen kırmızı

Kaydediyor ve kart dolmak üzere. Kartınızda 3 dakikadan daha az kayıt için süre kaldığında, gösterge yanıp sönmeye başlayacaktır.



Hızla yanıp sönen kırmızı

Kare düşürüyor. Kayıt hızına uyum sağlamak için SD kartın yazma hızı yeterli değil.



Sürekli sarı

Kart dolu, yazı korumalı ya da yazma hatası LED göstergenin kayıt esnasında sürekli sarı renkte yandığını görürseniz bu; SD kartın kötü olduğunu, yazma-korumalı olduğunu, henüz formatlanmamış olduğunu ya da 10 saniyeden daha az boş alanı olduğunu gösterir. Kilit düğmesini 'unlock' (kilidi aç) konumuna getirmeyi, veri oranını düşürmeyi, daha hızlı bir SD kartı kullanmayı, kartı formatlamayı ya da başka bir kartla değiştirmeyi deneyin.

Çoğaltıcınız; kayıt esnasında bir kartın çıkarılma olasılığına karşı, her bir karttaki dosya sistemini düzenli ve hazır olarak muhafaza etmeye çalışsa da Blackmagic Duplicator 4K kayıttayken, hiçbir SD kartı çıkarmamanız önemlidir. Bunun nedeni, kartı görüntülemek için kullanılan bazı işletim sistemlerinin, diğerleri kadar sağlam olmaması ve kaydı hasarlı olarak algılayabileceğidir. Bu bakımdan, bir kartı çıkarmadan önce kaydı durdurmak her zaman daha güvenlidir. Bir gösteri bitmeden önce katılımcılara kartları dağıtabilmeyi istediğinizde, birden fazla çoğaltıcı kullanmanız iyi bir fikir olabilir. Böylelikle, diğer üniteler kaydetmeye devam ederken, bir üniteye kartları dağıtmak için o üniteyi daha erken durdurabilirsiniz.

BİLGİ Class 10 hız dereceli SD kartlar, Blackmagic Duplicator 4K'nız tarafından desteklenen tüm data oranlarını kaydedebilirken, gerekirse daha düşük derecesi olan kartlara, daha düşük veri oranlarını da kaydedebilirsiniz. Örneğin, çok uzun bir müddet güvenlik görüntülerini kaydetmeyi isteyebilirsiniz ve bunun için en yüksek video kalitesi gerekli olmayabilir. SD kartınızın seçtiğiniz bit oranında video kaydedebildiğinden emin olmak için, daima bir deneme kaydı yapmanızı öneririz. SD kart hız dereceleri hakkında daha fazla bilgi için, bu kılavuzun 'Başlarken' kısmındaki 'SD kartlarının yerleştirilmesi ve formatlanması' bölümüne bakın.

Kayıt Ekleme

Çoğaltma modunda kaydederken, yeni bir klip kaydetmeyi ve sonra da tek bir klip olarak görünmeleri için, önce kaydedilen klibe eklemeyi isteyebilirsiniz. Örneğin, birden fazla etkinlikten oluşan bir performans kaydediyor olabilirsiniz. Her bir etkinliği ayrı ayrı kaydedip, tek bir klipte birleştirmeyi istediğinizde, 'append record' isimli kayıt ekleme özelliğinden faydalanabilirsiniz.

- 1 İlk klipi, her zamanki gibi 'record' butonunu kullanarak kaydedin. 'Stop' butonuna basarak kaydı durdurun.
- 2 Bir sonraki etkinlik başladığında, 'append record' butonuna basın. Bir önceki kaydettiğiniz klibe eklenecek bir klip kaydettiğinizi belirtmek için, bu buton, standart 'record' butonu ile birlikte yanacaktır.
- 3 'Stop' butonuna basarak kaydı durdurun. Bu yeni klip, ilk klibe eklenir ve tek bir klip olarak kaydedilir.

BİLGİ 'kayıt ekleme' özelliğini kullanarak ilk klibe ekleyebileceğiniz klip sayısında bir sınırlama yoktur. Dikkate alınması gereken, sadece kartın kapasitesi ve kayıtların uzunluğudur.

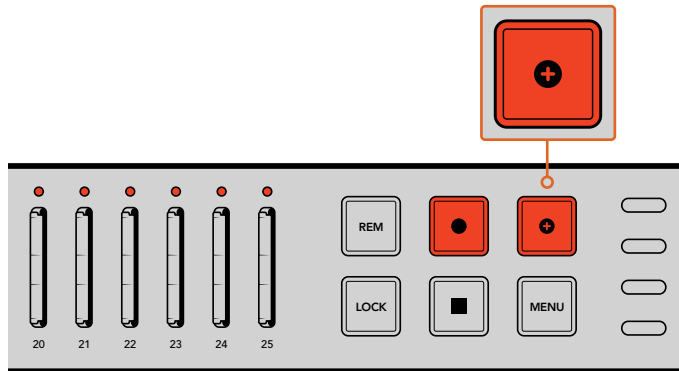

Daha önce kaydedilen bir klibe yeni bir klip eklemek için, 'append record' butonuna basın.

BİLGİ Tek disk modunda ya da tek disk üzerine yazma modunda kaydederken, kaydı bir sonraki karta geçirmek için 'record' (kayıt) butonunu üç saniyelikliğine basılı tutabilirsiniz. Böylelikle, mevcut kartı serbest hale getirmiş olursunuz. Bu, önemli bir etkinliğin gerçekleşmesinin ardından, bu etkinliğe hemen erişmeyi istediğinizde faydalı olabilir. Tek disk veya tek disk üzerine yazma modları hakkında daha fazla bilgi için, 'kayıt modunun ayarlanması' bölümüne bakınız. Çoğaltma modunda kaydederken, 'append record' (kayıt ekleme) butonuna basarak aynı işlemi gerçekleştirebilirsiniz. Daha fazla bilgi için, kılavuzun 'Kayıt ekleme' bölümüne bakın.

Blackmagic Duplicator 4K'nızın Kilitlenmesi

Önemli bir etkinliği kaydederken, kaydın kazayla durmasını önlemek için, kontrol panelini kilitlemeniz tavsiye edilir. Birbirine paralel bağlı olan bağımlı üniteleri de kilitlemekte fayda vardır. Böylelikle, üniteler üzerindeki herhangi bir kontrol düğmesinin kaydı kazayla engellemesini önlemiş olursunuz.

Kilitleme işlemi, her ünite de bulunan 'lock' butonu ile etkinleştirilerek veya etkisiz hale getirilerek, bağımsız olarak yapılır. Bir ünitenin kilidinin kazayla açılması çok düşük bir olasılıktır, çünkü bir ünitenin kontrollerinin kilidini açmak için, her ünite deki 'lock' butonunu fiziksel olarak 2 saniyelikliğine basılı tutmanız gerekir.

Bir Blackmagic Duplicator 4K'yı kilitlemek için:

- 1 Blackmagic Duplicator 4K'nızın kontrol panelindeki 'lock' (kilitle) butonuna basın.
- 2 Ünitenin kilidini açmak için, 'lock' butonunu basılı tutun. İki saniye sonra, ünitenin kilidi açılacaktır.

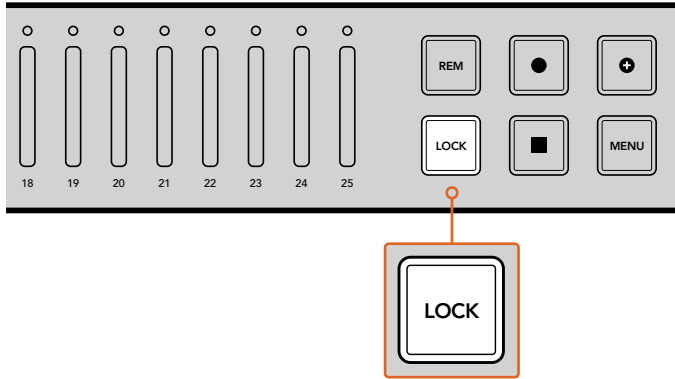

Blackmagic Duplicator 4K'nızın kontrol panelinin kilitlemesi, kazayla bir kaydı durdurma riskini önler.

Birden Fazla Çoğaltıcının Birbirine Bağlanması

25 adedin üzerinde SD karta kayıt yapmanız gerektiğinde, birden fazla Blackmagic Duplicator 4K'yı birbirine bağlayabilirsiniz. Üniteler birbirlerine paralel olarak bağlandıklarında, her bir ünitenin 'loop' (düz geçiş) SDI konektörü üzerinden aynı video sinyali paylaşırlar ve ayrıca RS-422 protokolünü kullanarak, 'remote' (uzaktan kontrol) konektörleri ile birbirleri ile iletişim kurarlar.

Birden fazla Blackmagic Duplicator 4K'yı birbirine bağlamak için:

- 1 İlk ünitenin RS-422 'remote out' (uzaktan kontrol çıkışı) portunu, DB-9 konektörleri olan yaygın bir seri kablo ile, ikinci ünitenin 'remote in' (uzaktan kontrol girişi) portuna bağlayın. DB-9 konektörleri olan seri kablolar, bilgisayar veya video ekipmanları satan mağazalarda yaygın olarak bulunur.
- 2 İlk ünitenin 'loop' SDI çıkışını ikinci ünitenin SDI girişine bağlayın.

Gerçekten bu kadar kolay! Birden fazla Blackmagic Duplicator 4K'yı birbirine paralel olarak bağlamak için, her bir 'uzaktan kontrol' ve 'loop' çıkışını, bir sonraki ünitenin uzaktan kontrol ve SDI girişlerine takın ve bu işleme, zincirin sonundaki üniteye kadar devam edin.

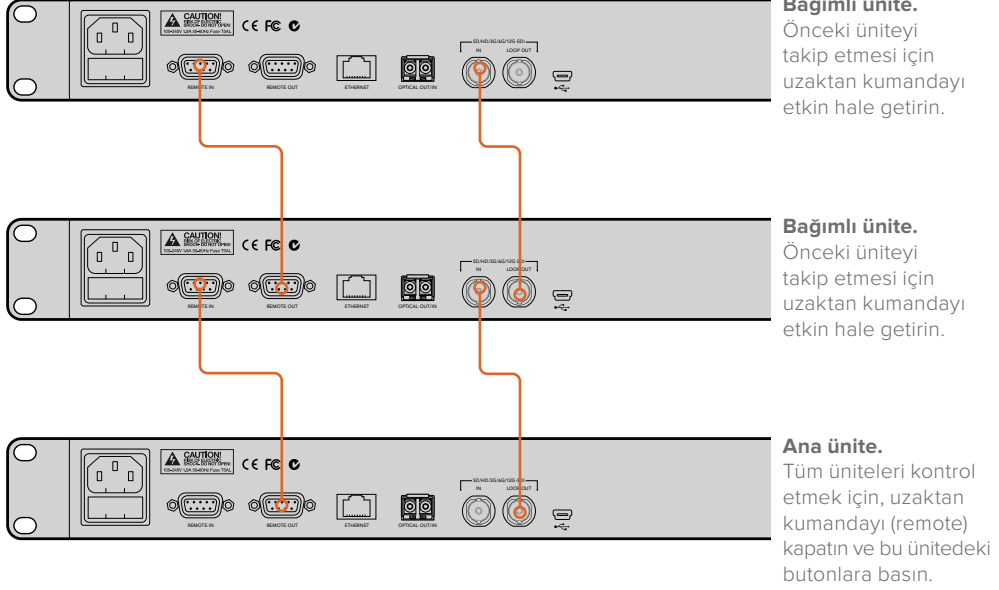

Birden fazla Blackmagic Duplicator 4K'yı birbirine paralel şekilde bağlamak için, bir ünitenin loop çıkışını bir sonraki ünitenin SDI girişine bağlayın. Benzer bir şekilde, bir ünitenin 'uzaktan kontrol' çıkışını, diğer ünitenin 'uzaktan kontrol' girişine bağlayın.

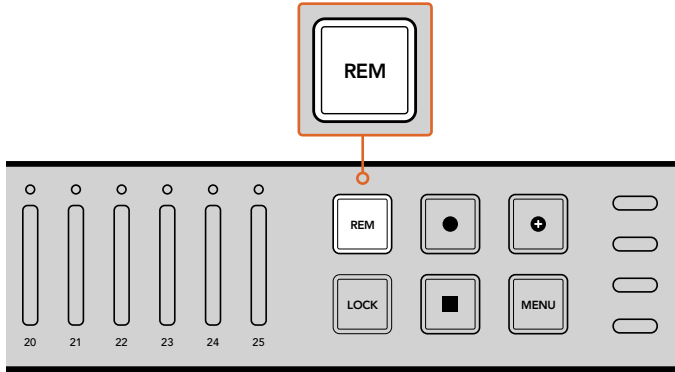

İlk ünite tarafından uzaktan kontrol edilebilmeleri için, zincirde bulunan bağımlı ünitelerin her birindeki uzaktan kontrol butonuna basın.

NOT Uzaktan kontrol özelliğini etkinleştirmek için, her bir bağımlı ünitenin kontrol panelindeki 'uzaktan kontrol' butonuna bastığınızdan emin olun. Uzaktan kontrol etkinleştirildiğinde, 'remote' butonunun ışığı yanar. Etkisiz hale getirmek için tekrar basın.

Kesin kaydı yapmadan önce, tüm ünitelerin ana ünite tarafından kontrol edildiğinden emin olmak için, bir deneme kaydı yapmanızda fayda vardır. Eğer bağımlı üniteler, ana ünitenin komutlarını uygulamıyorsa ana üniteye uzaktan kontrol butonunun kapalı olduğundan ve bağımlı ünitelerin uzaktan kontrol butonlarının açık olduğundan emin olun.

LCD Menü Ayarları

Blackmagic Duplicator 4K'nızın tüm ayarları, kontrol panelindeki LCD menüsünden ve ekran butonları ile değiştirilebilir. Bu ekran butonları, LCD ekranın her iki yanında bulunur ve LCD menüsünde görüntülenen ayarlara uyumlu şekilde yanarlar.

Bir ayarı değiştirmek için:

- 1 LCD menü ayarlarını açmak için, kontrol panelindeki 'menu' butonuna basın.
- 2 Menüdeki ayarlar arasında gezinmek için menüdeki ekran butonlarını kullanın.
- 3 İstediğiniz ayarı seçtiğinizde, 'change' (değiştir) menü ekran butonuna basın.
- 4 Ayarı düzenleyin, sonra da değişikliği onaylamak için, 'set' ibaresine basın.

Bu değişikliği, menüde 'back' (geri) ekran butonuna basarak her zaman iptal edebilirsiniz. Bu butona basmanız, sizi menüde bir önceki adıma götürecektir. Alternatif olarak, kontrol panelindeki 'menu' butonuna bastığınızda, LCD ekranını ana ekrana geri götürecektir.

Kaydet

'Kayıt' ayarları; video kaynağını değiştirmenize, bit oranını ayarlamanıza, kayıt tetiklemeyi etkinleştirmenize veya etkisiz hale getirmenize ve SD kartlarınızı formatlamanıza imkan verir.

Video Kaynağı

Fiber optik SDI modülü takılı olduğunda, SDI girişi ve fiber optik girişi arasında seçim yapmanız, bu ayar sağlar.

Mode (Mod)

Bu ayarı, kayıt modunu belirlemek için kullanın:

Çoğalt

Tüm SD kartlara aynı anda aynı videoyu kaydedin.

Tek Disk

Bir seferde bir tek SD karta yazın ve SD kart dolduğunda, sıradaki kullanılabilir SD kartta yazma işlemini sürdürün. Tüm SD kartlar dolduğunda, Duplicator 4K kayıt işlemine son verir. Birden fazla üniteyi birbirlerine paralel bağladıysanız tüm SD kartlar dolana dek, bir sonraki Duplicator 4K'da kayıt devam eder.

Tek Disk Üzerine Yazma (Single Disk Overwrite)

Aralıksız bir döngü kaydedin. Bir seferde bir tek SD karta yazın ve SD kart dolduğunda, sıradaki kullanılabilir SD kartta yazma işlemini sürdürün. Tüm kartlar dolduğunda, Duplicator 4K ilk SD karta geri döner ve kayıt işlemine devam eder.

Codec (Kodek)

Bu ayarı; Blackmagic Duplicator 4K'nızı H.264 ve H.265 sıkıştırma kodekleriyle kaydetmesi için ayarlamak üzere kullanın.

Bu iki farklı kodeğin tanımları aşağıdadır.

H.264

Görüntü kalitesi ile dosya boyutu arasında iyi bir denge sunan, yaygın olarak kullanılan bir sıkıştırıcıdır. Son on yılda üretilen oynatma cihazlarının çoğu, bu kodek ile sıkıştırılan dosyaları, en az HD çözünürlüğünde görüntüleyebilir.

H.265

H.264'e kıyasla, belirli bir görüntü kalitesi için, video dosya büyüklüğünü yarıya indirebilen oldukça etkili sıkıştırıcıdır. Bu codec, yüksek kaliteli veya Ultra HD video teslim etmek için mükemmeldir fakat, izlemek için daha güncel oynatım yazılımı ve donanımı gerektirebilir.

NOT H.264 ve H.265 arasındaki farklılıklar hakkında daha fazla bilgi için, bu kılavuzun 'kaydetme' bölümüne bakınız.

Bit Oranı

Bit oranı ayarı, SD kartlarınıza ne kadar video kaydedileceğini ve video kaydının kalitesini belirler. Seçebileceğiniz üç seçenek vardır.

Yüksek

Asgari derecede sıkıştırma ile en yüksek kalitede video istediğinizde, 'yüksek' ayarını seçin.

Orta

SD kartlarınıza daha çok video kaydetmek ve çok iyi görüntü kalitesi istediğinizde, 'orta' ayarını seçin.

Düşük

SD kartlarınıza olabildiğince çok video sığdırmak istediğinizde ve en yüksek kaliteye ihtiyacınız olmadığında, 'düşük' ayarını seçin. Bu ayar, azami derecede sıkıştırma kullanır. Bu bakımdan, kaydınızda sıkıştırma nedeniyle oluşan, gözle görülür görüntü bozuklukları olabilir.

NOT Dahili H.265 kodlayıcı, en son sıkıştırma teknolojisini kullanır. Böylelikle, asgari ölçüde veri kullanarak yüksek kalitede video kayıtları alabilirsiniz. En düşük kalite ayarında bile, video sıkıştırmanın çoğu ile, kayıtlarınızın kalitesi yine de çok iyi olacaktır.

Video Formatları için Bit Oranları

Ultra HD			
Video Formatı	Bit Oranı Ayarı	H.264 Bit Hızı (Mb/s)	H.265 Bit Hızı (Mb/s)
2160p60	Yüksek	75	50
	Orta	66	38
	Düşük	50	20
2160p59.94	Yüksek	75	50
	Orta	66	38
	Düşük	50	20

Ultra HD			
Video Formatı	Bit Oranı Ayarı	H.264 Bit Hızı (Mb/s)	H.265 Bit Hızı (Mb/s)
2160p50	Yüksek	72	48
	Orta	61	32
	Düşük	42	16
2160p30	Yüksek	50	30
	Orta	37	20
	Düşük	24	10
2160p29.97	Yüksek	50	30
	Orta	37	20
	Düşük	24	10
2160p25	Yüksek	40	25
	Orta	32	18
	Düşük	20	10
2160p24	Yüksek	40	25
	Orta	32	18
	Düşük	20	10
2160p23.98	Yüksek	40	25
	Orta	32	18
	Düşük	20	10

HD			
Video Formatı	Bit Oranı Ayarı	H.264 Bit Hızı (Mb/s)	H.265 Bit Hızı (Mb/s)
1080p60	Yüksek	40	20
	Orta	32	15
	Düşük	20	10
1080i60	Yüksek	40	20
	Orta	32	15
	Düşük	20	10
1080p59.94	Yüksek	40	20
	Orta	32	15
	Düşük	20	10
1080i59.94	Yüksek	40	20
	Orta	32	15
	Düşük	20	10
1080p50	Yüksek	36	20
	Orta	28	15
	Düşük	18	10

HD			
Video Formatı	Bit Oranı Ayarı	H.264 Bit Hızı (Mb/s)	H.265 Bit Hızı (Mb/s)
1080i50	Yüksek	36	20
	Orta	28	15
	Düşük	18	10
1080p30	Yüksek	28	15
	Orta	20	11
	Düşük	11	7
1080p29.97	Yüksek	28	15
	Orta	20	11
	Düşük	11	7
1080p25	Yüksek	24	15
	Orta	16	10
	Düşük	9	6
1080p24	Yüksek	24	15
	Orta	15	10
	Düşük	8	6
1080p23.98	Yüksek	24	15
	Orta	15	10
	Düşük	8	6
720p60	Yüksek	25	12
	Orta	17	10
	Düşük	9	8
720p59.94	Yüksek	25	12
	Orta	17	10
	Düşük	9	8
720p50	Yüksek	20	12
	Orta	14	9
	Düşük	7	6

SD			
Video Formatı	Bit Oranı Ayarı	H.264 Bit Hızı (Mb/s)	H.265 Bit Hızı (Mb/s)
625i50 PAL	Yüksek	18	11
	Orta	12	8
	Düşük	6	6
525i59.94 NTSC	Yüksek	20	12
	Orta	14	9
	Düşük	7	6

Trigger (Tetikleme)

Tetikleme ayarı; Blackmagic URSA Mini gibi, diğer SDI ekipmanların üzerindeki kayıt butonu ile tetikleyerek, Blackmagic Duplicator 4K'nızda kaydı başlatmanızı sağlayan kayıt tetikleme özelliğini çalıştırır.

None (Hiçbiri)

Kayıt tetikleme özelliğini etkisizleştirmek için 'none' (hiç biri) seçeneğini seçin.

SDI Başlat/Durdur

SDI Başlat/Durdur seçili olduğunda, diğer SDI ekipmanınızdaki kayıt düğmesine bastığınız zaman, Blackmagic Duplicator 4K'nız kaydetmeye başlayabilir.

Örneğin, Blackmagic URSA Mini, SDI çıkışları üzerinden daima bir kayıt tetikleme sinyali gönderir. Böylelikle, kameranızda kayıt düğmesine bastığınızda, Blackmagic Duplicator 4K'nız kaydetmeye başlar ve sonra kayıt düğmesine tekrar bastığınızda da kaydı durdurur. URSA Mini'deki kayıt tetikleme özelliğini etkinleştirmek için, herhangi bir ayar yapmanız gerekli değildir, ama kayıt tetikleme özelliğini destekleyen başka SDI ekipman kullanıyor ve bu ekipman ile kaydı tetiklemek istiyorsanız, ekipmanınızın ayarlar menüsünden, SDI başlat/durdur kayıt tetikleme özelliğini etkinleştirmeniz gerekecektir.

Zaman Kodu Çalıştırma

SDI ekipmanınız SDI başlat/durdur kayıt tetiklemeyi desteklemiyorsa, çalışmaya başlayan bir zaman kodu tespit eder etmez kayda başlaması için Blackmagic Duplicator 4K'yı ayarlayabilirsiniz. Örneğin, Blackmagic Duplicator 4K'nıza bağlı bir SDI kamera varsa ve kamera 'record run' zaman koduna ayarlı ise, Blackmagic Duplicator 4K'nızı kayda başlaması için tetikler. Kameranızda kaydı durdurduğunuzda zaman kodu da durur ve Blackmagic Duplicator 4K'nızdaki kayıt da duracaktır.

Bu mükemmel bir özelliktir, fakat ekipmanınızın zaman kodunun 'record run' olarak ayarlı olduğundan emin olmanız gerekir. Eğer zaman kodunuzun ayarı 'time of day' (günlük saat) olarak ayarlı ise, çalışan zaman kodunu sürekli olarak çıkarır ve Blackmagic Duplicator 4K'nızda kaydı tetiklemeye devam eder ve bunu da istemezsiniz.

Kartların Formatlanması

Blackmagic Duplicator 4K'nın formatlama özelliği ile, 25 adede kadar kartı aynı anda formatlayabilirsiniz.

Kartlarınızı formatlamak için:

- 1 LCD menüsünü açmak için, kontrol panelinin üzerindeki 'menu' butonuna basın.
- 2 Kayıt ayarlarını açmak için ekrandaki 'record' butonuna basın.
- 3 'Format cards' (kartları formatla) ayarına gitmek için, ekrandaki sol veya sağ ok butonuna ve 'format' butonuna basın.
- 4 Formatı doğrulamanız için bir mesaj belirecektir. Bu işlemin geriye alınamayacağına dair bir uyarı mesajı da göreceksiniz. SD kartlarınızda tutmak istediğiniz herhangi bir veri varsa, işleme devam etmeden önce bunları yedeklediğinizden emin olun.
- 5 İşlemi onaylamak için 'format' ibaresini tıklayın. Ayrıca, 'cancel' (iptal) ibaresine de basabilir ve kayıt ayarlarına geri dönebilirsiniz.
- 6 Kartlarınız formatlanırken, durum LED göstergeleri sarı renkte yanıp sönecektir ve LCD ekranda bir ilerleme çubuğu görünecektir. Kartlar formatlandığında, durum göstergeleri yeşil renkte kalır ve LCD ekran menüsü, formatlama işleminin tamamlandığını ve kartlarınızın artık kayıt işlemine hazır olduğunu belirten bir mesaj gösterir.
- 7 OK butonuna basın. Sonra, ana ekrana geri dönmek için kontrol panelindeki 'menu' butonuna basın.

Ayarlar

'Settings' (ayarlar) menüsü; DHCP açık veya kapalı, IP adresi, alt ağ maskesi ve ağ geçidi gibi, Blackmagic Duplicator 4K'nızın ağ ayarlarının değiştirilmesi için kullanılır. Blackmagic Duplicator 4K'nızı bir ağa bağladığınızda, Telnet gibi üçüncü parti yönetim yazılımı ile, üniteyi uzaktan kontrol edebilirsiniz.

DHCP 'ON' (AÇIK)

Bir ağa bağlandığında, Blackmagic Duplicator 4K'nızın en iyi ayarları otomatik olarak yapılandırabilmesi için, 'on' (açık) seçeneğini seçin. Böylece, Blackmagic Duplicator 4K'nız ağda bağlı tüm cihazları kontrol eder ve olası herhangi bir ayar uyumsuzluğunu önlemek için, IP adresini ve diğer ağ ayarlarını düzenler. Bu, ağ ayarlarınızın hızla çalışmasını sağlamanın çok güvenilir ve kolay bir yoludur.

DHCP 'OFF' (KAPALI)

Ağ ayarlarınız üzerinde tam manuel kontrole sahip olmak istiyorsanız, DHCP'yi 'off' olarak ayarlayabilir ve daha sonra IP adresi, alt ağ maskesi ve ağ geçidi ayarlarına giderek, bunları manuel olarak değiştirebilirsiniz.

IP Adresi, Alt Ağ Maskesi ve Ağ Geçidi

DHCP 'off' olarak ayarlıyken, bu ayarları manuel olarak değiştirebilirsiniz.

Sayı alanlarını değiştirmek için:

- 1 Sol ya da sağ programlanabilir menü butonları ile sayı alanını seçin ve 'change' (değiştir) butonuna basın.
- 2 Sayının değerini artırmak ya da azaltmak için, programlanabilir sol ve sağ menü butonlarına basın. Daha hızlı gezinmek için, yazılım butonlarını basılı tutabilirsiniz.
- 3 Değişikliği onaylamak için, 'set' butonuna basın.

Sıralamanın geri kalanı üzerinde gezinmek ve gerekli değişiklikleri yapmak için artık programlanabilir menü butonlarını kullanabilirsiniz.



Telnet gibi üçüncü parti yönetim yazılımı ile, Blackmagic Duplicator 4K'nızı kontrol edebilmeniz için, 'ayarlar' LCD menüsü ile ağ ayarlarını değiştirebilirsiniz.

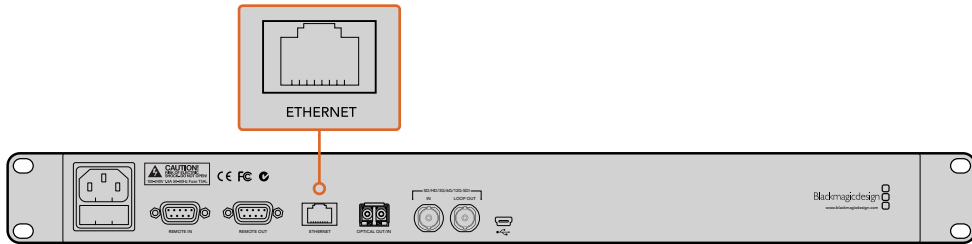

Arka paneldeki Ethernet portundan, Blackmagic Duplicator 4K'nızı ağınıza bağlayın.

Hakkında

Bu menü ayarı; şu anki bit oranı ayarını, son kaydınızın dosya adını, ağ durumunu ve Blackmagic Duplicator 4K'nızdaki dahili yazılımın sürümünü göstererek anında bir genel değerlendirme sunar.

Blackmagic Duplicator Yardımcı Yazılımı

Blackmagic Duplicator 4K'nızın Güncellenmesi

Blackmagic Duplicator Yardımcı yazılımı; Blackmagic Duplicator 4K'nızın dahili yazılımını güncellemek ve ayrıca kayıtlarınızı etiketlendirmeniz için 'file name prefix' (dosya adı öneki) ayarını değiştirmek üzere kullanılır. Yeni özelliklerden ve geliştirmelerden yararlanmanız için, yazılımı indirmenizi ve Blackmagic Duplicator 4K'nızı güncellemeğinizi öneririz.

Yazılımın en son sürümü, www.blackmagicdesign.com/tr/support adresindeki Blackmagic Design destek merkezinden indirilebilir.

Dahili yazılımı macOS bilgisayarlarda güncellemek için:

- 1 Blackmagic Duplicator Yardımcı Yazılımını indirip zip dosyasını açın.
- 2 Karşınıza çıkan disk görüntüsünü açın ve Blackmagic Duplicator Yardımcı Yazılım Yükleyicisini başlatın. Ekrandaki talimatları takip edin.
- 3 En son Blackmagic Duplicator Yardımcı Yazılımını yükledikten sonra, Blackmagic Duplicator 4K'yi bir USB kablosu ile bilgisayarınıza bağlayın.
- 4 Duplicator Yardımcı Yazılımını başlatın ve 'settings' (ayarlar) dairesel ikonunu tıklayarak ayarları açın. Yazılım, Blackmagic Duplicator 4K'da daha eski bir sürümü tespit ederse 'update now' (şimdi güncelle) ikonunu görüntüler. Dahili yazılımı güncellemek için, sadece bu ikonu tıklayın. Blackmagic Duplicator 4K'nızda dahili yazılımın en son sürümü yüklü ise, başka bir şey yapmanıza gerek yoktur.

Dahili yazılımı Windows bilgisayarlarda güncellemek için:

- 1 Blackmagic Duplicator Yardımcı Yazılımını indirip zip dosyasını açın.
- 2 Bu kılavuzu ve Blackmagic Duplicator Yardımcı Yazılım Yükleyicisini içeren bir Blackmagic Duplicator Yardımcı Yazılım dosyasını göreceksiniz. Yükleyiciyi çift tıklayın ve kurulumu tamamlamak için ekrandaki komutları takip edin.
- 3 En son Blackmagic Duplicator Yardımcı Yazılımını yükledikten sonra, Blackmagic Duplicator 4K'nızı bir USB kablosu ile bilgisayarınıza bağlayın.
- 4 Duplicator Yardımcı Yazılımını başlatın ve 'settings' (ayarlar) dairesel ikonunu tıklayarak ayarları açın. Yazılım, Blackmagic Duplicator 4K'da daha eski bir sürümü tespit ederse 'update now' (şimdi güncelle) ikonunu görüntüler. Dahili yazılımı güncellemek için, sadece bu ikonu tıklayın. Blackmagic Duplicator 4K'nızda dahili yazılımın en son sürümü yüklü ise, başka bir şey yapmanıza gerek yoktur.

File Name Prefix (Dosya Adı Öneki)

Kayıtlarınızın etiketlenmesi ve kolaylıkla belirlenebilmesi için dosya adı önekiyi değiştirebilirsiniz. Bunun için, 'File Name Prefix' (Dosya Adı Öneki) düzenleme kutusunu tıklayın ve yeni bir dosya adı girin. Artık Blackmagic Duplicator 4K'nız bir dahaki klibi kaydettiğinde, kayıt dosyasının isminde; özel bir isim ve klip numarasını tanımlamak için ismi takip eden dört rakam olacaktır. Kaydedilen her klip ile bu rakamlar artar.

Birbirlerine paralel baęlı ünitelerde, baęımlı ünitelerdeki uzaktan kontrol butonlarına basıp ve ardından ana üniteadaki dosya adı öneki ayarını deęiřtirerek, tüm kayıtların da aynı dosya adını aldıęından emin olabilirsiniz. Böylelikle, klipleri kaydederken, tüm ünitelerdeki kartların hepsinin aynı dosya adını almasını sağlayabilirsiniz.

İsteęe Baęlı Optik Fiber SDI Modülünün Takılması

Fiber optik üzerinden SDI video baęlantısı istiyorsanız isteęe baęlı olan fiber SDI modülünü takmanız gerekir. SMPTE uyumlu her SFP fiber optik modülü takılabilir ve Blackmagic Design yetkili satıcılarından ayrı olarak satın alınabilir. Modül, Blackmagic Duplicator 4K'nızın arka panelindeki dahili fiber optik kafesine takılır. Fiber optik SDI modülü takılıyken, gömülü ses içeren SDI video sinyalini, son derece uzun mesafelere kabloyla taşıyabilirsiniz. Ayrıca, optik çıkışı, ilave bir video düz geçiř (loop) baęlantısı olarak da kullanabilirsiniz.

3G-SDI veya 6G-SDI fiber optik gibi, daha yavaş hızda çalıřan fiber optik sistemleri kullanıyorsanız ve daha yüksek hızlara ihtiyacınız yoksa maliyeti düşürmek için, bu yuvaya daha yavaş bir modül takabilirsiniz.

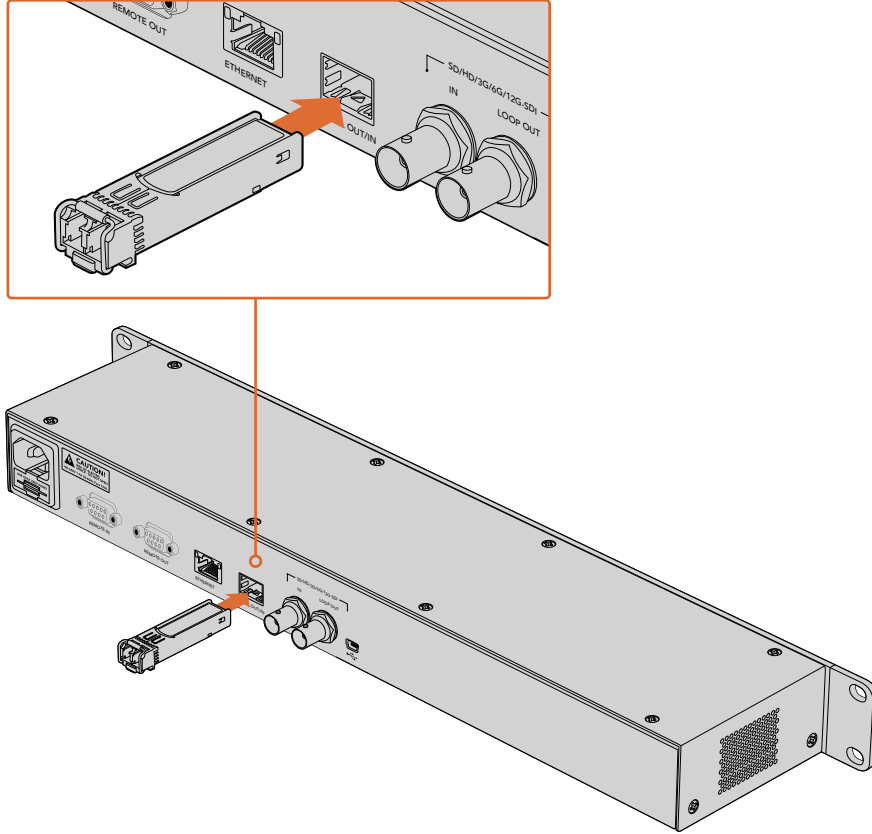

Opsiyonel fiber optik SDI modülü takarak fiber optik kablo ile SDI video baęlayabilirsiniz.

Blackmagic Duplicator 4K, ilk takılan video konektörünü kullanır, ama hem SDI hem de fiber optik baęladıęınızda, LCD menüsündeki 'video source' (video kaynaęı) ayarı ile ikisi arasında seçim yapabilirsiniz. Daha fazla bilgi için, 'ayarlar' bölümüne bakın.

RS-422 Kontrol

RS-422 Kontrol Nedir?

RS-422 standardı, bir seri deck kontrol yayın standardıdır ve yayıncılar tarafından 1980'lerin başlarından beri kullanılmaktadır ve birçok deck'te, doğrusal kurgu makinalarında, sayısal kurgu sistemlerinde ve yayın otomasyon ürünlerinde bulunur. Blackmagic Duplicator 4K bu standardı destekler böylece; yayın otomasyonuna, uzaktan kontrol sistemlerine, zamanlanmış kayıt sistemlerine ve kendi tasarlamak istediğiniz herhangi bir özel kontrol sistemine entegre edilebilir.

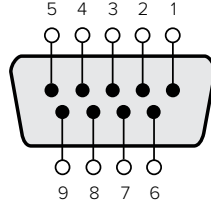

Transmit (-) (negatif yayımla)	Transmit (+) (pozitif yayımla)	Receive (-) (negatif al)	Receive (+) (pozitif al)	Ground Pins (topraklama pimleri)
2	7	8	3	1, 4, 6, 9

Uzaktan kontrol giriş konektörü için RS-422 uzaktan kontrol pim bağlantıları.

Harici bir RS-422 Kontrolörünün Kullanımı

Blackmagic Duplicator 4K'nızın, endüstri standardı Sony(tm) ile uyumlu bir RS-422 deck 'uzaktan' kontrol portu vardır. Üzerinde RS-422 olan herhangi bir uzaktan kontrol cihazına direkt bağlanması için, bu portun doğru pim bağlantıları vardır.

Her iki ucu 'pime pim' bağlanmış, yani kablunun her iki ucundaki pim numaralarının birbirine aynı kablo ile bağlandığı, 9 pimli hazır kabloları kullanabilirsiniz. Ekipmanınız farklı bir kablo sistemine sahipse ve kendinize özel kablolar yapmayı istiyorsanız lütfen, beraberinde gelen uzaktan kontrol girişi bağlantı şemasına bakınız. Böylelikle, verici (transmit) veya Tx pimlerinin, alıcı veya Rx pimlerine bağlandığından emin olabilirsiniz.

Blackmagic Duplicator 4K'nıza harici bir RS-422 kontrolör bağlayarak, cihaz üzerindeki butonlara basmak yerine, üniteyi uzaktan kontrol edebilirsiniz.

- 1 Bir RS-422 kablosunu, harici kontrolörünüzden Blackmagic Duplicator 4K'nın uzaktan kontrol girişine bağlayın.
- 2 Uzaktan deck kontrolünü etkinleştirmek için, Blackmagic Duplicator 4K kontrol panelinde, 'REM' olarak işaretli uzaktan kontrol butonuna basın.

Artık Blackmagic Duplicator 4K'nız ile kaydı veya kayıt ekleme işlemini uzaktan başlatabilir veya durdurabilirsiniz. Desteklenen RS-422 komutlarının tam listesi, bir sonraki 'desteklenen RS-422 komutları' adlı bölümdedir.

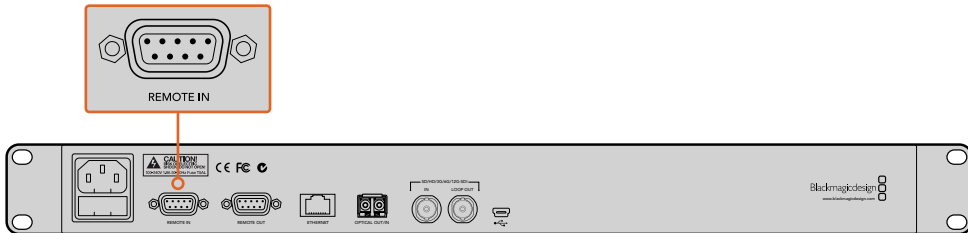

Üniteyi uzaktan kontrol etmek için, harici bir RS-422 kontrolörünü Blackmagic Duplicator 4K'nın uzaktan kontrol girişine takın.

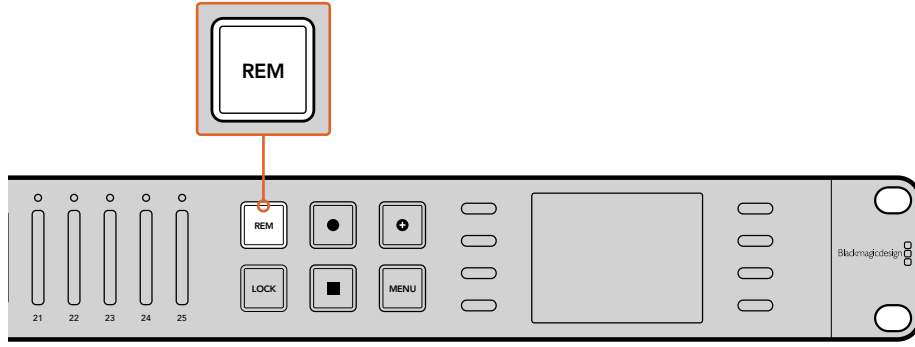

RS-422 deck kontrolünü etkinleştirmek için, Blackmagic Duplicator 4K kontrol panelindeki uzaktan kontrol butonuna basın.

Desteklenen RS-422 Komutları

		Komut	Yanıt	Uzaktan kontrol yok	Açıklayıcı Notlar
0 - Sistem Kontrolü					
0x00	0x11	CihazTipiTalebi	NTSC: 0xF0E0 PAL: 0xF1E0 24P: 0xF2E0	Etkin	–

1 - Bağımlı Birim Yanıtı					
0x20	0x00	Durdur	Kabul et	Etkin değil	–
0x20	0x02	Kaydet	Kabul et	Etkin değil	–
0x21	0x02	Ekle	Kabul et	Etkin değil	Standart olmayan komut - 0x00'ın ekstra bir yükü eklemeyi belirtir

4 - Önayar/Seçme Kontrolü					
0x40	0x40	OtomatikMod Kapalı	Kabul et	Etkin değil	Gözardı edildi, Durum birimi hatırlandı
0x40	0x41	OtomatikMod Açık	Kabul et	Etkin değil	Gözardı edildi, Durum birimi hatırlandı
0x61	0x20	DurumAlgısı	DurumVerisi	Etkin	–

7 - Algı Yanıtı					
0x70	0x20	DurumVerisi	–	–	Lütfen 'Durum Birimleri' sayfasına bakın: 9 baytlık duruma limitlidir, fazlası sessizce kesilir.

RS-422 Yazılım Geliştirici Bilgileri

	Bit 7	Bit 6	Bit 5	Bit 4	Bit 3	Bit 2	Bit 1	Bit 0
Bayt 0	0	0	Kaset çıkar	0	0	0	0	Yerel
Bayt 1	Bekle	0	Durdur	0	0	0	Kaydet	0
Bayt 2	0	0	0	0	0	0	0	0
Bayt 3	Otomatik Mod	0	0	0	0	0	0	0
Bayt 4	EE'yi seç	Tam EE	0	0	0	0	0	0
Bayt 5	0	0	0	0	0	0	0	0
Bayt 6	0	0	0	0	0	0	0	0
Bayt 7	0	0	0	0	0	0	0	0
Bayt 8	0	0	0	0	0	0	0	0
Bayt 9	0	0	0	0	0	0	0	0

Değişkenler	
Kaset Çıkar	Kayda hazır bir kart olmadığında ayarla
Yerel	Yerel kontrol modundayken ayarla (uzaktan kontrol yok)
Bekle	Kayda hazır bir veya iki kart olduğunda ayarla
Otomatik Mod	Sadece uyumluluk için
Tam EE	Sadece uyumluluk için - daima açık
EE'yi seç	Sadece uyumluluk için - daima açık

Blackmagic Duplicator 4K RS-422 Ayarları	
Protokol	Sony 9-pim protokolü baz alınmıştır
Bilgi Akış (Baud) Hızı	38.4 K
Başlama Bit'leri	1
Veri Bit'leri	8
Durdurma Bit'leri	1
Parite Bit'leri	1
Parite Tipi	Tek Sayı

Ethernet ile Uzaktan Kontrol

Blackmagic Duplicator 4K'nız, Blackmagic HyperDeck Ethernet Protokolündeki yazı bazlı komutlar kullanılarak, Ethernet aracılığıyla harici olarak kontrol edilebilir. Bu da size, Telnet gibi bir yönetim yazılımını kullanarak, Blackmagic Duplicator 4K'nızı bir bilgisayardan uzaktan kontrol etmenizi sağlar. Ayrıca, kendi özel donanım kontrol panelinizi geliştirebilir ve HyperDeck Ethernet Protokolünü kullanarak, Blackmagic Duplicator 4K'nıza entegre olması için programlayabilirsiniz.

Çoğaltıcınızı, bilgisayarlardan ya da özel donanım kontrol cihazlarından veya yayın stüdyolarında ve yayın araçlarında kullanılan büyük sistemlerden kontrol etmek için, kendi özel çözümlerinizi geliştirebilirsiniz. Örneğin, Arduino mikrokontrolörler, 'shields' isimli genişletme kartları ile isteğe göre uyarlanabilen küçük devre kartlarıdır. Çok çeşitli genişletme kartı vardır ve farklı konektörleri barındırabilirler. Blackmagic Duplicator 4K'nızı kontrol etmek için, bir Ethernet shield gereklidir. Programlanabilir butonları olan ilave genişletme kartları bile satın alabilirsiniz! Arduino mikrokontrolörlerin kurulumu kolaydır, uygun fiyatlıdır ve tamamıyla açık kaynaklıdır. Arduino yazılımını programladıktan sonra, Arduino'yu Blackmagic Duplicator 4K'nızın Ethernet portuna bağlayıp çoğaltıcınızı hemen kontrol etmeye başlayabilirsiniz.

Bir Arduino üzerinden Kontrol Etme için bir Örnek

Arduino mikrokontrolörler, yaygın C program dili ile programlanırlar. Kontrolörünüzü; HyperDeck Ethernet Prokolünü kullanarak Blackmagic Duplicator 4K'nıza komut tetiklemesi için programlayın. Desteklenen tüm komutları, "Blackmagic HyperDeck Ethernet Protokölü" başlıklı bir sonraki bölümde bulabilirsiniz.

Çeşitli kayıt işlevlerini uygulamak için, Arduino'nuz başka genişletme kartları da ekleyebilirsiniz. Örneğin; dahili bir saat eklediğinizde, günün belirli saatlerinde kaydetmesi için Blackmagic Duplicator 4K'ya komut vermesi için kontrolörünüzü programlayabilirsiniz. Bu da güvenlik kayıtlarının zamanlarını düzenlerken faydalı olabilir.

Bu teknoloji, bizi çok heyecanlandırdı ve kurduğunuz herhangi bir harici Ethernet kontrolörü hakkında deneyimlerinizi duymayı isteriz!



```
BlackmagicDuplicatorControl | Arduino 1.6.5
BlackmagicDuplicatorControl
/*
 * Telnet client Blackmagic Duplicator 4K Control
 *
 * Circuit:
 * * Ethernet shield attached to pins 10, 11, 12, 13
 */
#include <SPI.h>
#include <Ethernet.h>

// Enter a MAC address and IP address for your controller below.
// The IP address will be dependent on your local network:
byte mac[] = {0x90, 0xA2, 0xDA, 0x0F, 0x17, 0xEF};
byte ip[] = {192, 168, 28, 204};
byte server[] = {192, 168, 28, 85};

EthernetClient client;

void setup()
{
  Ethernet.begin(mac, ip);
  client.connect(server, 9993);
}

void loop()
{
  while (client.available())
  {
    char c = client.read();
  }

  client.print("record: name: CAMERA1\x0a");
  delay(60000);
  client.print(">stop\x0a");
  while (1);
}
```

Done Saving

Sketch uses 9,710 bytes (30%) of program storage space. Maximum is 32,256 bytes.
Global variables use 236 bytes (11%) of dynamic memory, leaving 1,812 bytes for local variables. Maximum is 2,048 bytes.

36 Arduino/Genuino Uno on /dev/tty.usbmodem1421

Bir Arduino'yu bir Ethernet shield ile kullandığımız örnekte olduğu gibi, bir harici Ethernet kontrolörünü programlarken, dilediğiniz kontrole sahip olmak için kullanmanız gereken komutları seçerken yapmanız gereken şey, buradaki Ethernet protokol referans bilgilerinden faydalanmanızdır.

Yukarıdaki resimde gösterilen kod, Arduino IDE'nize (Tümleşik Geliştirme Ortamı) kopyalayıp yapıştırabilmeniz için, bir sonraki sayfada da sunulmaktadır. Bu kod; Blackmagic Duplicator 4K'nın bir dakikalığına kaydetmesi ve daha sonra kaydı durdurması ve program tekrar çalışana kadar beklemesi için komut vermek üzere Arduino'yu programlar.

```
/*
   Telnet client Blackmagic Duplicator 4K Control Circuit: *
Ethernet shield attached to pins 10, 11, 12, 13
*/
#include <SPI.h>
#include <Ethernet.h>
// Enter a MAC address and IP address for your controller below.
// The IP address will be dependent on your local network:
byte mac[] = {0x90, 0xA2, 0xDA, 0x0F, 0x17, 0xEF};
byte ip[] = {192, 168, 28, 204};      // IP address of Ethernet Shield
byte server[] = {192, 168, 28, 141};  // IP address of Duplicator
EthernetClient client;                // Give the ethernet client a name

void setup()
{
  Ethernet.begin(mac, ip);            //Start the Ethernet connection:

  client.connect(server, 9993);       //Connect to Duplicator on port 9993
}
void loop()
{
  while (client.available())          //Read the Duplicator Preamble
  {
    char c = client.read();
  }
  client.print("record: name: Camera1\x0a");
  //Start Duplicator recording a clip named Camera 1
  delay(60000);                       //Wait a minute
  client.print("stop\x0a");           //Stop recoding
  while (1);                          //Do nothing until program
  starts again
}
}
```

Blackmagic HyperDeck Ethernet Protokolü

Blackmagic HyperDeck Ethernet Protokolü; aslında Blackmagic HyperDeck disk kaydedicilerinin Ethernet portu üzerinden kontrol edilmeleri için yazılmış, metin tabanlı bir protokoldür, fakat aynı protokolü Blackmagic Duplicator 4K'nızı kontrol etmek için de kullanabilirsiniz.

Duplicator sadece kayıt yaptığı için, HyperDeck protokolünün tam komut setine sahip değildir. Lakin, bu bölümde, çoğaltıcı üzerinde HyperDeck Ethernet protokolünü kullanırken geçerli olan mevcut komutları görebilirsiniz.

Protocol Komutları

Komut	Komut Açıklaması
help or ?	Tüm komut ve parametrelerle yardım metni sağlar.
remote	HyperDeck'in uzaktan kontrol modunu sorgular.
remote: enable: true	Uzaktan kontrolü etkinleştirir.
remote: enable: false	Uzaktan kontrolü etkisiz hale getirir.
remote: override: true	Uzaktan geçersiz kılmayı etkinleştirir.
remote: override: false	Uzaktan geçersiz kılmayı etkisiz hale getirir.
quit	HyperDeck sunucusundan bağlantıyı keser.
ping	HyperDeck sunucusunun yanıt verip vermediğini belirler.
record	Kayı başlatır.
record: append: true	Kayı ekleme işlemini başlatır.
stop	Oynatımı veya kaydı durdurur.
commands	Desteklenen tüm komutları bir XML formatında listeler.
notify	Tüm bildirimlerin güncel durumunu sorgular.
notify: transport: true	Aktarım bildirimlerini etkinleştirir.
notify: transport: false	Aktarım bildirimlerini etkisiz hale getirir.
notify: slot: true	Yuva bildirimlerini etkinleştirir.
notify: slot: false	Yuva bildirimlerini etkisiz hale getirir.
notify: remote: true	Uzaktan kontrol bildirimlerini etkinleştirir.
notify: remote: false	Uzaktan kontrol bildirimlerini etkisiz hale getirir.
notify: configuration: true	Yapılandırma bildirimlerini etkinleştirir.
notify: configuration: false	Yapılandırma bildirimlerini etkisiz hale getirir.
notify: dropped frames: true	Düşen kare bildirimlerini etkinleştirir.
notify: dropped frames: false	Düşen kare bildirimlerini etkisiz hale getirir.
device info	Cihaz bilgilerini sunar.
slot info: slot id: {slot ID}	Belirli bir yuva için bilgi sunar.
transport info	Aktarımın durumu hakkında bilgi sunar.
configuration	Mevcut yapılandırmayı sorgular.
configuration: record mode: Duplicate	Çoğaltmak için kayıt modunu yapılandırır.
configuration: record mode: SingleDisk	Kayıt modunu tek disk olarak yapılandırır.

Komut	Komut Açıklaması
configuration: record mode: DiskOverwrite	Kayıt modunu disk üzerine yazma olarak yapılandırır.
configuration: video input: {"SDI", "optical"}	Video girişini yapılandırır.
configuration: file format: {format}	Kayıt kodeğini ve bit oranını yapılandırır.
format: prepare: {format}	Bir disk formatlama işlemini, {format} dosya sistemine hazırlar.
format: confirm: {token}	Bir belirteç (token) kullanarak, önceden hazırlanmış bir formatlama işlemi uygula
watchdog: period: {seconds}	Watchdog (koruma) özelliğini yapılandırır.

XML Kullanımı

HyperDeck ile iletişim için Terminal uygulamasını kullanabilmenize rağmen, bir program yazıyorsanız iletişimde olduğunuz HyperDeck'in donanım yazılımına dayanan belli bir komutun varlığını teyit etmek için XML'yi kullanabilirsiniz. Bu; yazılım kullanıcı arayüzünün, belli bir HyperDeck modeli ve yazılım sürümünün kapasitesine uyum sağlaması için yardımcı olur.

Protocol Details

Connection

The HyperDeck Ethernet server listens on TCP port 9993.

Basic syntax

The HyperDeck protocol is a line oriented text protocol. Lines from the server will be separated by an ASCII CR LF sequence. Messages from the client may be separated by LF or CR LF.

New lines are represented in this document as a "`\n`" symbol.

Command syntax

Command parameters are usually optional. A command with no parameters is terminated with a new line:

```
{Command name}\n
```

If parameters are specified, the command name is followed by a colon, then pairs of parameter names and values. Each parameter name is terminated with a colon character:

```
{Command name}: {Parameter}: {Value} {Parameter}: {Value} ...\n
```

Response syntax

Simple responses from the server consist of a three digit response code and descriptive text terminated by a new line:

```
{Response code} {Response text}\n
```

If a response carries parameters, the response text is terminated with a colon, and parameter name and value pairs follow on subsequent lines until a blank line is returned:

```
{Response code} {Response text}:\n
{Parameter}: {Value}\n
{Parameter}: {Value}\n
...
\n
```

Successful response codes

A simple acknowledgement of a command is indicated with a response code of 200:

```
200 ok\n
```

Other successful responses carry parameters and are indicated with response codes in the range of 201 to 299.

Failure response codes

Failure responses to commands are indicated with response codes in the range of 100 to 199:

```
100 syntax error
101 unsupported parameter
102 invalid value
103 unsupported
104 disk full
105 no disk
106 disk error
109 out of range
110 no input
111 remote control disabled
120 connection rejected
150 invalid state
```

Asynchronous response codes

The server may return asynchronous messages at any time. These responses are indicated with response codes in the range of 500 to 599:

```
5xx {Response Text}:↵
{Parameter}: {Value}↵
{Parameter}: {Value}↵
↵
```

Connection response

On connection, an asynchronous message will be delivered:

```
500 connection info:↵
protocol version: {Version}↵
model: {Model Name}↵
↵
```

Connection rejection

Only one client may connect to the server at a time. If other clients attempt to connect concurrently, they will receive an error and be disconnected:

```
120 connection rejected↵
```

Timecode syntax

Timecodes are expressed as non-drop-frame timecode in the format:

```
HH:MM:SS:FF
```

Handling of deck "remote" state

The "remote" command may be used to enable or disable the remote control of the deck. Any attempt to change the deck state over ethernet while remote access is disabled will generate an error:

```
111 remote control disabled↵
```

To enable or disable remote control:

```
remote: enable: {"true", "false"} ↵
```

The current remote control state may be overridden allowing remote access over ethernet irrespective of the current remote control state:

```
remote: override: {"true", "false"} ↵
```

The override state is only valid for the currently connected ethernet client and only while the connection remains open.

The "remote" command may be used to query the remote control state of the deck by specifying no parameters:

```
remote↵
```

The deck will return the current remote control state:

```
210 remote info:↵
enabled: {"true", "false"}↵
override: {"true", "false"}↵
↵
```

Asynchronous remote control information change notification is disabled by default and may be configured with the "notify" command. When enabled, changes in remote state will generate a "510 remote info:" asynchronous message with the same parameters as the "210 remote info:" message.

Closing connection

The "quit" command instructs the server to cleanly shut down the connection:

```
quit↵
```

Checking connection status

The "ping" command has no function other than to determine if the server is responding:

```
ping↵
```

Getting help

The "help" or "?" commands return human readable help text describing all available commands and parameters:

```
help↵
```

or:

```
?↵
```

The server will respond with a list of all supported commands:

```
201 help:↵
{Help Text}↵
{Help Text}↵
↵
```

Stopping deck operation

The "stop" command instructs the deck to stop the current capture:

```
stop↵
```

Enumerating supported commands and parameters

The "commands" command returns the supported commands:

```
commands↵
```

The command list is returned in a computer readable XML format:

```
212 commands:
<commands>↵
    <command name="..."><parameter name="...">...</command>↵
    <command name="..."><parameter name="...">...</command>↵
    ...
</commands>↵
↵
```

More XML tokens and parameters may be added in later releases.

Controlling asynchronous notifications

The "notify" command may be used to enable or disable asynchronous notifications from the server. To enable or disable transport notifications:

```
notify: transport: {"true", "false"}↵
```

To enable or disable slot notifications:

```
notify: slot: {"true", "false"}↵
```

To enable or disable remote notifications:

```
notify: remote: {"true", "false"}↵
```

To enable or disable configuration notifications:

```
notify: configuration: {"true", "false"}↵
```

To enable or disable dropped frames notifications:

```
notify: dropped frames: {"true", "false"}↵
```

Multiple parameters may be specified. If no parameters are specified, the server returns the current state of all notifications:

```
209 notify:↵
transport: {"true", "false"}↵
slot: {"true", "false"}↵
remote: {"true", "false"}↵
configuration: {"true", "false"}↵
↵
```

Retrieving device information

The "device info" command returns information about the connected deck device:

```
device info↵
```

The server will respond with:

```
204 device info:↵
protocol version: {Version}↵
model: {Model Name}↵
unique id: {unique alphanumeric identifier}↵
↵
```

Example of response from server:

```
204 device info:↵
protocol version: 1.8↵
model: Blackmagic Duplicator 4K↵
unique id: 101112131415↵
↵
```

Retrieving slot information

The "slot info" command returns information about a slot.

The specified slot will be queried:

```
slot info: slot id: {Slot ID}↵
```

The server will respond with slot specific information:

```
202 slot info:↵
slot id: {Slot ID}↵
status: {"empty", "mounting", "error", "mounted"}↵
volume name: {Volume name}↵
recording time: {recording time available in seconds}↵
video format: {disk's default video format}↵
↵
```

Asynchronous slot information change notification is disabled by default and may be configured with the “notify” command. When enabled, changes in slot state will generate a “502 slot info:” asynchronous message with the same parameters as the “202 slot info:” message.

Retrieving transport information

The “transport info” command returns the state of the transport:

```
transport info ↵
```

The server responds with transport specific information:

```
208 transport info:↵
status: {"stopped","record"}↵
display timecode: {timecode}↵
timecode: {timecode}↵
```

The “timecode” value is the timecode within the current timeline for playback or the clip for record. The “display timecode” is the timecode displayed on the front of the deck. The two timecodes will differ in some deck modes.

Asynchronous transport information change notification is disabled by default and may be configured with the “notify” command. When enabled, changes in transport state will generate a “508 transport info:” asynchronous message with the same parameters as the “208 transport info:” message.

Video Formats

The following video formats are currently supported on Blackmagic Duplicator 4K:

SD

525i59.94 NTSC

625i50 PAL

HD

720p50	1080p30
720p59.94	1080i50
720p60	1080p50
1080p23.98	1080i59.94
1080p24	1080p59.94
1080p25	1080i60
1080p29.97	1080p60

Ultra HD

2160p23.98	2160p30
2160p24	2160p50
2160p25	2160p59.94
2160p29.97	2160p60

Duplicator 4K supports progressive segmented frame modes, and automatically detects level A and level B 3G-SDI formats for 1080p50, 1080p59.94 and 1080p60.

File Formats

Duplicator 4K supports the following file formats:

- H.264Low
- H.264Medium
- H.264High
- H.265Low
- H.265Medium
- H.265High

Querying and updating configuration information

The "configuration" command may be used to query the current configuration of the deck:

```
configuration↵
```

The server returns the configuration of the deck:

```
211 configuration:↵  
video input: {"SDI", "optical"}↵  
↵
```

One or more configuration parameters may be specified to change the configuration of the deck.

To change the current video input:

```
configuration: video input: {"SDI", "optical"}↵
```

Configuring the watchdog

The "watchdog" command instructs the deck to monitor the connected client and terminate the connection if the client is inactive for at least a specified period of time.

To configure the watchdog:

```
watchdog: period: {period in seconds}↵
```

To avoid disconnection, the client must send a command to the server at least every {period} seconds. Note that if the period is set to 0 or less than 0, connection monitoring will be disabled.

Configuring the record mode

Use the 'record mode' command to select the deck recording mode:

```
configuration: record mode: {"Duplicate", "SingleDisk", "DiskOverwrite"}↵
```

Configuring the file format

The 'file format' command instructs the deck to switch to a specific file format for codec and bit rate:

```
configuration: file format: {"H.264High", "H.264Medium", "H.264Low",  
"H.265High", "H.265Medium", "H.265Low"}↵
```

Yardım

Yardım İin

Yardım almanın en hızlı yolu, Blackmagic Design online destek sayfalarına girip, Blackmagic Duplicator 4K'nız için mevcut olan en son destek malzemesini incelemenizdir.

Blackmagic Design Online Destek Sayfaları

En son kılavuz, yazılım ve destek notlarına www.blackmagicdesign.com/tr/support adresindeki Blackmagic Design destek merkezinden ulaşılabilir.

Blackmagic Design Forum

Web sitemizdeki Blackmagic Design forum, daha fazla bilgi ve yaratıcı fikirler için ziyaret edebileceğiniz faydalı bir kaynaktır. Burası yardım alabilmeniz için daha hızlı bir yol olabilir çünkü başka deneyimli kullanıcılar ya da Blackmagic Design çalışanları tarafından sorularınıza yanıtlar bulabilir ve çalışmalarınıza bu sayede devam edebilirsiniz. Forumu <https://forum.blackmagicdesign.com/tr> adresinden ulaşabilirsiniz.

Blackmagic Design Destek Ekibiyle İrtibat

Aradığınız yardımı destek kaynaklarında ya da forumda bulamadığınız durumda, lütfen destek sayfamıza girerek "Bize e-posta gönderin" butonuna tıklayarak, e-posta yoluyla destek talebinde bulunun. Bunun yerine, destek sayfasındaki "Yerel destek ekibini arayın" butonunu tıklayıp size en yakın olan Blackmagic Design destek ofisini arayabilirsiniz.

Mevcut Yazılım Sürümünün Kontrol Edilmesi

Bilgisayarınızda Blackmagic Duplicator Utility yazılımının hangi sürümünün yüklü olduğuna göz atmak için, 'About Blackmagic Duplicator Utility' penceresini açın.

- macOS sistemlerde, Blackmagic Duplicator Utility'i, Applications (Uygulamalar) dosyasından açın. Sürüm numarasını görüntülemek için uygulamalar menüsünden 'About Blackmagic Duplicator Utility'i seçin.
- Windows 8.1 işletim sisteminde, Başlat sayfasındaki Blackmagic Duplicator Utility penceresinden Blackmagic Duplicator Yardımcı Yazılımını açın. Sürüm numarasını görüntülemek için Help (Yardım) menüsüne tıklayın ve About Blackmagic Duplicator Utility'i seçin.
- Windows 10 işletim sisteminde, Blackmagic Duplicator Utility uygulamasını Başlat menüsünden açın. Sürüm numarasını görüntülemek için Help (Yardım) menüsüne tıklayın ve About Blackmagic Duplicator Utility'i seçin.

En Son Yazılım Güncellemelerine Erişim

Bilgisayarınızda yüklü bulunan Blackmagic Duplicator Yardımcı yazılımının sürümünü kontrol ettikten sonra, lütfen Blackmagic Design destek merkezine www.blackmagicdesign.com/tr/support adresinden girerek en son güncellemeleri gözden geçirin. En son güncellemeleri çalıştırmak faydalı olsa da önemli bir projenin ortasında, yazılımı güncellemekten kaçınmakta yarar vardır.

Düzenleyici Uyarıları

Avrupa Birliği Dahilinde Elektrikli ve Elektronik Cihazlara Dair Atık Kontrol Yönetmeliği.



Ürün üzerindeki sembol, bu cihazın başka atık malzemelerle bertaraf edilmemesi şartını belirler. Atık cihazlarınızı bertaraf edebilmemiz için, geri dönüşümünü sağlamak üzere, belirlenmiş toplama noktasına teslim edilmeleri gerekmektedir. Bertaraf anında atık cihazlarınızın ayrı olarak toplanması ve geri dönüşümü, doğal kaynakların korunmasına yardımcı olacaktır ve insan sağlığını ve çevreyi koruyucu bir şekilde geri dönüşümünü sağlayacaktır. Atık cihazlarınızı geri dönüşüm için nereye teslim edebileceğiniz konusunda daha fazla bilgi için, lütfen yerel belediyenizin geri dönüşüm şubesini ya da ürünü satın aldığınız satış bayisini arayınız.



Bu cihaz, test edilmiş ve Federal İletişim Komisyonu (FCC) koşullarının 15. bölümü doğrultusunda A Sınıfı dijital cihazların sınırlarıyla uyumlu olduğu tespit edilmiştir. İlgili sınırlar, bu cihaz ticari bir ortamda çalıştırıldığı takdirde, zararlı müdahalelere karşı makul koruma sağlaması için tasarlanmıştır. Bu cihaz; radyo frekans enerjisi üretir, kullanır ve saçabilir ve talimatlar doğrultusunda kurulmadığı ve kullanılmadığı takdirde, radyo iletişimlerine zararlı müdahaleye yol açabilir. Bu ürünün bir yerleşim bölgesinde çalıştırılmasının zararlı müdahaleye yol açması muhtemeldir, bu durumda kullanıcı, müdahalenin düzeltilmesi için ilgili maliyeti, kendi cebinden karşılamak zorunda kalacaktır.

Bu ürünün çalıştırılması aşağıdaki şartlara bağlıdır:

- 1 Bu cihaz, zararlı müdahaleye sebebiyet vermemelidir.
- 2 Bu cihaz, arzu edilmeyen bir çalışma şekline yol açacak müdahale de dahil olmak üzere, maruz kaldığı her türlü müdahaleyi kabul etmelidir.

ISED Kanada Beyannamesi

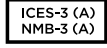

Bu cihaz, A Sınıfı dijital cihazlar için Kanada standartlarıyla uyumludur.

Bu cihaza yapılacak herhangi bir değişiklik veya kullanım amacı dışında kullanılması, bu standartlara uyumluluğunu hükümsüz kılabilir.

Bu cihaz, ticari ortamda kullanım amacına uygunluk için test edilmiştir. Cihaz ev ortamında kullanıldığında, radyo parazitine neden olabilir.

Güvenlik Bilgileri

Elektrik çarpmalarına karşı korunmak için, bu cihaz koruyucu topraklama bağlantısı olan bir şebeke prizine takılmalıdır. Şüpheli durumlarda, kalifiye bir elektrik teknisyeniyle iletişime geçin.

Elektrik çarpma riskini azaltmak için, bu ekipmanı damlayan veya sıçrayan suya maruz bırakmayın.

Ürün, ortam ısısı 40° C'ye kadar olan tropikal ortamlarda kullanılmaya uygundur.

Bu ürünün çevresinde yeterli havalandırma olduğundan ve hava akımının kısıtlanmadığından emin olun.

Rafa monte ederken, bitişik cihazlardan dolayı hava akımının kısıtlanmadığından emin olun.

Ürün içinde, kullanıcı tarafından tamir edilebilecek hiçbir parça bulunmamaktadır. Gerekli tamiratları, yerel Blackmagic Design hizmet merkezine yönlendirin.

Bazı ürünlere küçük form-faktörü alıcı-verici (SFP) optik fiber modülleri takılabilir. Yalnızca Lazer 1. sınıf optik SFP modüllerini kullanın.

Önerilen Blackmagic Design SFP modülleri:

- **3G-SDI:** PL-4F20-311C
- **6G-SDI:** PL-8F10-311C
- **12G-SDI:** PL-TG10-311C



Deniz seviyesinden yüksekliği 2000m'yi aşmadığı yerlerde kullanın.

Kaliforniya Eyalet Beyannamesi

Bu ürün; hexavalent chromium (altı değerlikli Krom) dahil olmak üzere, Kaliforniya Eyaleti tarafından kanser, doğum özürlü ve başka üreme zararlarına sebep olduğu bilinen kimyasallara, sizi maruz bırakabilir.

Daha fazla bilgi için, www.P65Warnings.ca.gov adresini ziyaret ediniz.

Yetkili Servis Personeli için Uyarı



Dikkat - Double Pole/ Neutral Fusing (İki Kutuplu/Nötr Sigorta)

Bu ekipmanda bulunan güç kaynağını hem hat iletkeninde hem de nötr iletkeninde elektrik sigortası bulunur ve Norveç'teki IT elektrik dağıtım sistemine bağlantı için uygundur.

Garanti

12 Ay Sınırlı Garanti

Blackmagic Design şirketi, Blackmagic Duplicator 4K'nın satın alındığı tarihten itibaren 12 ay boyunca malzeme ve işçilik bakımından kusursuz olacağını garantilemektedir. Üründe, bu garanti süresi içinde bir arıza ve kusur söz konusu olursa Blackmagic Design, kendi seçimi doğrultusunda ya arızalı ürünü parça ve işçilik bedeli talep etmeksizin tamir edecektir ya da arızalı ürünü yenisiyle değiştirecektir.

Bu garanti kapsamındaki hizmetten yararlanmak için, kusur ve hataya ilişkin garanti süresi sona ermeden, Müşteri Blackmagic Design'i bilgilendirmeli ve söz konusu hizmetin sağlanması için uygun düzenlemeleri yapmalıdır. Blackmagic Design tarafından özel belirlenmiş ve yetkilendirilmiş bir hizmet merkezine arızalı ürünün ambalajlanarak nakliyesi, Müşteri'nin sorumluluğudur ve nakliye ücretleri, peşin ödenmiş olmalıdır. Bize herhangi bir sebepten dolayı iade edilen ürünlerin tüm nakliyat değişiklikleri, sigorta, yasal bedel, vergi ve diğer tüm masrafları, müşterinin sorumluluğundadır.

Bu garanti; yanlış kullanım ya da yanlış veya kusurlu bakımdan kaynaklanan herhangi bir arızayı, bozukluğu ya da hasarı kapsamaz. Blackmagic Design burada açıklanan durumlarda, bu garanti kapsamında hizmet sağlamak zorunda değildir: a) Blackmagic Design temsilcileri haricindeki başka personelin ürünü kurma, tamir etme ya da bakımını yapma girişimlerinden kaynaklanan hasarın tamir edilmesi, b) uygun olmayan kullanım veya uyumlu olmayan ekipmanlara bağlanılmasından kaynaklanan hasarın tamir edilmesi, c) Blackmagic Design parçaları ya da malzemesi olmayan ürünlerin kullanımından kaynaklanan hasarın ya da arızanın tamir edilmesi ya da d) Modifiye veya başka ürünlerle entegre edilmiş bir ürünün; söz konusu modifikasyon ya da entegrasyonun gereken tamiratın süresini uzattığı ya da ürün bakımını zorlaştırdığı durumlarda, tamir edilmesi. BU GARANTİ, BLACKMAGIC DESIGN TARAFINDAN VERİLMİŞTİR VE AÇIK YA DA ZİMNİ, HERHANGİ BİR GARANTİNİN YERİNİ TUTAR. BLACKMAGIC DESIGN VE SATICILARI, ZİMNİ TİCARİ UYGUNLUK GARANTİSİNİ YA DA ÖZEL BİR AMACA UYGUNLUK GARANTİSİNİ KABUL ETMEZ. KUSURLU BİR ÜRÜNÜN TAMİRİ VEYA DEĞİŞTİRİLMESİ, BLACKMAGIC DESIGN'IN MÜŞTERİLERİNE SUNDUĞU TAM VE MÜNHASİR ÇÖZÜMDÜR. BLACKMAGIC DESIGN YA DA SATICILARININ, OLABİLECEK HASARLAR HAKKINDA ÖNCEDEN BİLGİSİ OLMASINI GÖZETMEKSİZİN; ÜRÜNDE DOLAYLI, ÖZEL, TESADÜFİ YA DA NETİCE OLARAK ORTAYA ÇIKAN HERHANGİ BİR HASAR İÇİN, BLACKMAGIC DESIGN SORUMLU DEĞİLDİR. BLACKMAGIC DESIGN, MÜŞTERİLER TARAFINDAN CİHAZIN YASAL OLMAYAN HERHANGİ BİR KULLANIMINDAN, SORUMLU DEĞİLDİR. BLACKMAGIC DESIGN, BU ÜRÜNÜN KULLANIMINDAN KAYNAKLANAN HERHANGİ BİR HASARDAN, SORUMLU DEĞİLDİR. BU ÜRÜNÜN ÇALIŞTIRILMASINDAN DOĞAN RİSK, KULLANICININ KENDİSİNE AİTTİR.

© Telif Hakkı Saklıdır 2019 Blackmagic Design. Tüm Hakları Saklıdır. 'Blackmagic Design', 'DeckLink', 'HDLink', 'Workgroup Videohub', 'Intensity' ve 'Leading the creative video revolution', ABD ve diğer ülkelerde tescil edilmiş ticari markalardır. Diğer tüm şirket ve ürün isimleri, bağlantılı oldukları ilgili şirketler/firmaların ticari markaları olabilir. Thunderbolt ve Thunderbolt logosu ABD ve/ya başka ülkelerdeki Intel Corporation'un ticari markalarıdır.